



Security Tech Germany

GAMME VÉLO

CATALOGUE

2024



PICTOGRAMMES



Nouveau produit



Nouvelle couleur

ANTIVOLS



Double verrouillage

Double verrouillage de l'anse dans le boîtier



Format de poche

Antivol petit format



Format XL

Antivol grand format



Clé lumineuse

Clé lumineuse contenue dans la livraison



Fermeture sans clé

Ne requiert pas de clé pour la fermeture de l'antivol



Sangle robuste

Tissu high-tech. Résistant aux intempéries et hydrophobe



Code programmable

La combinaison de chiffres peut être choisie librement



Rechargeable

Batterie / pile rechargeable



Antivol de cadre universel

Cet antivol de cadre peut être monté sur tous les cadres de vélo grâce à son système d'ouvertures variable



Batterie / Pile

Batterie / pile incluse



SmartX

Système de verrouillage innovant, contrôlé à l'aide d'un smartphone



XPlus

Cylindre résistant au vol « X Plus »



Poids léger

Antivol léger, idéal pour les activités sportives



Alarme

Antivol offrant une fonction d'alarme à 100 dB



OEM

Les antivol sont fournis sans emballage de vente et offrent ainsi un montage plus rapide. Convient parfaitement pour une utilisation dans des ateliers



Option de clé unique

Fabrication spéciale possible : la même clé peut être utilisée pour plusieurs antivol

CASQUES



Filet anti-moustiques

Protection intégrale contre les insectes



Compatible avec la queue-de-cheval

Casque qui convient parfaitement aux personnes ayant les cheveux longs



Demi-anneau

Demi-anneau ajustable entourant la moitié de la tête, relié au système de serrage



Anneau complet

Anneau ajustable entourant toute la tête, relié au système de serrage



ActiCage

Renforcement structurel intégré à l'EPS pour une stabilité optimale



Taille XL

Casques de grandes tailles disponibles (62+ cm)



Ventilation

Nombre d'aérations entrantes et sortantes



Quin Ready

Le casque peut être équipé du système QUIN



Quin

QUIN est un capteur de détection d'impact qui appelle automatiquement les secours dans les situations d'urgence



ABUS

DESIGNED & ENGINEERED
IN GERMANY

ABUS

ABUS

SOMMAIRE



| | |
|-------------------------------------------------|-----|
| ABUS - Made in Germany | 004 |
| Label de qualité | 005 |
| ONE KEY | 006 |
| Service Clé | 010 |
| Le système de niveau ABUS | 012 |
| | |
| Antivols en U | 014 |
| Antivols pliables | 026 |
| Chaînes | 042 |
| Antivols Goose | 062 |
| Steel-0-Flex | 066 |
| Antivols câble en spirale | 074 |
| Antivols de cadre et serrures de batterie | 090 |
| Sécurités diverses | 104 |
| Supports d'antivols et sacoches | 128 |
| | |
| ABUS OEM | 148 |
| | |
| Route | 150 |
| VTT | 178 |
| Urbain | 196 |
| Enfants | 238 |
| Accessoires de casque | 260 |
| | |
| Lumino | 268 |
| | |
| Présentoirs et POS | 278 |
| | |
| Index des articles | 287 |

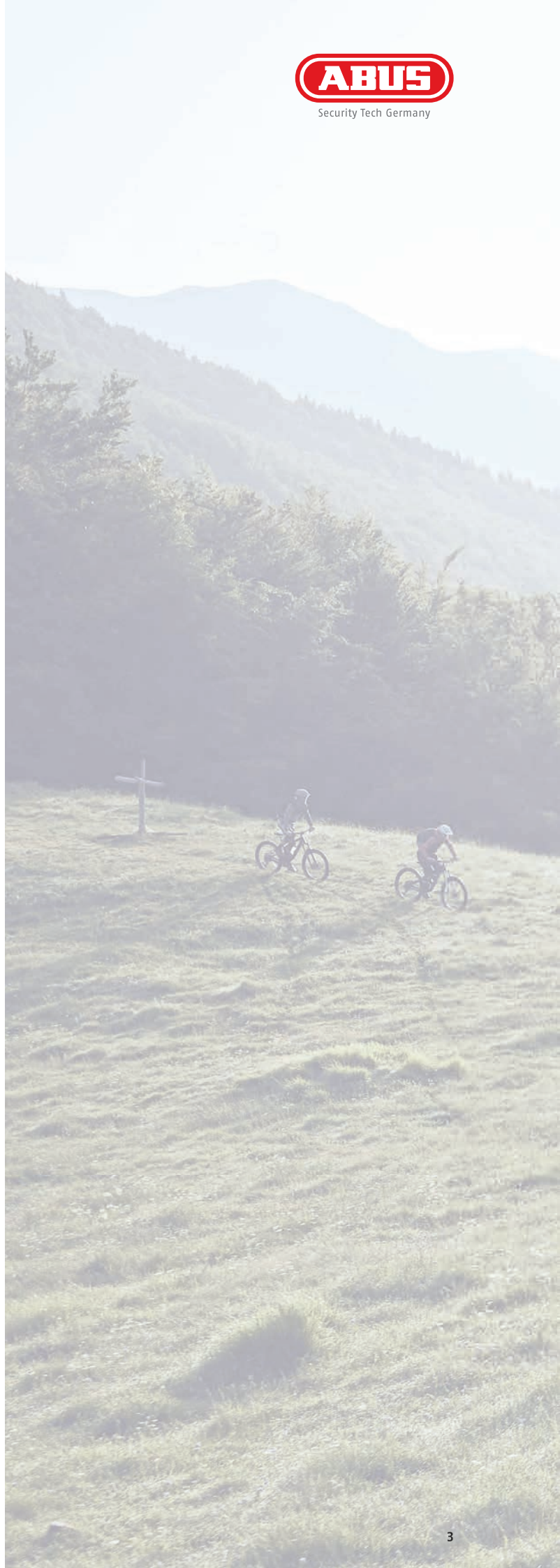

ABUS - MADE IN GERMANY

À la création de l'entreprise en 1924 par August Bremicker et ses fils, ces derniers possédaient une grande habilité manuelle. – mais aussi une vision : leur objectif était de fabriquer des produits protégeant la vie et les biens des personnes. Une ligne de conduite judicieuse de l'entreprise - associée à une recherche de qualité dès le commencement. C'était le prélude à une réussite continue. La marque ABUS s'est peu à peu imposée en tant que garant en termes de sécurité.



MATÉRIAUX DE HAUTE QUALITÉ

Pour pouvoir offrir une qualité et une sécurité élevées sur la durée, nous utilisons des matériaux de haute qualité dans toutes les gammes de prix. Des processus de durcissement professionnels garantissent une résistance optimale de nos matériaux. Notre service qualité interne vérifie l'ensemble des matériaux avant et pendant le processus de fabrication et assure que chaque produit offre toujours la même qualité supérieure.

LA CLÉ VERS LE SUCCÈS

Chez ABUS nous fabriquons nous-même un grand nombre de machines ainsi que l'ensemble des outils nécessaires pour la production de nos produits de sécurité. Cela permet de réunir savoir-faire, emplois stables et une forte identité. Notre service d'ingénierie et d'outillage canalise son énergie exclusivement sur le développement d'antivols destinés aux vélos et aux motos. Cela nous permet de nous assurer que nous répondons aux exigences élevées en termes de protection contre le vol de vélos et de motos.

NOUS ASSURONS NOTRE PÉRENNITÉ

Dans le laboratoire de contrôle et de tests, nous vérifions régulièrement la résistance de nos antivols afin de pouvoir garantir la qualité constante de nos produits. Les tests englobent entre autres :

- des vérifications dans une chambre froide à -40 ° C pour simuler les conditions météorologiques les plus froides et des attaques au spray cryogène
- des simulations réalistes en conditions de vol avec des attaques sur nos antivols par torsion, par traction, par martelage et par sciage
- des vérifications relatives à la longévité et à la résistance dans des milieux hautement corrosifs

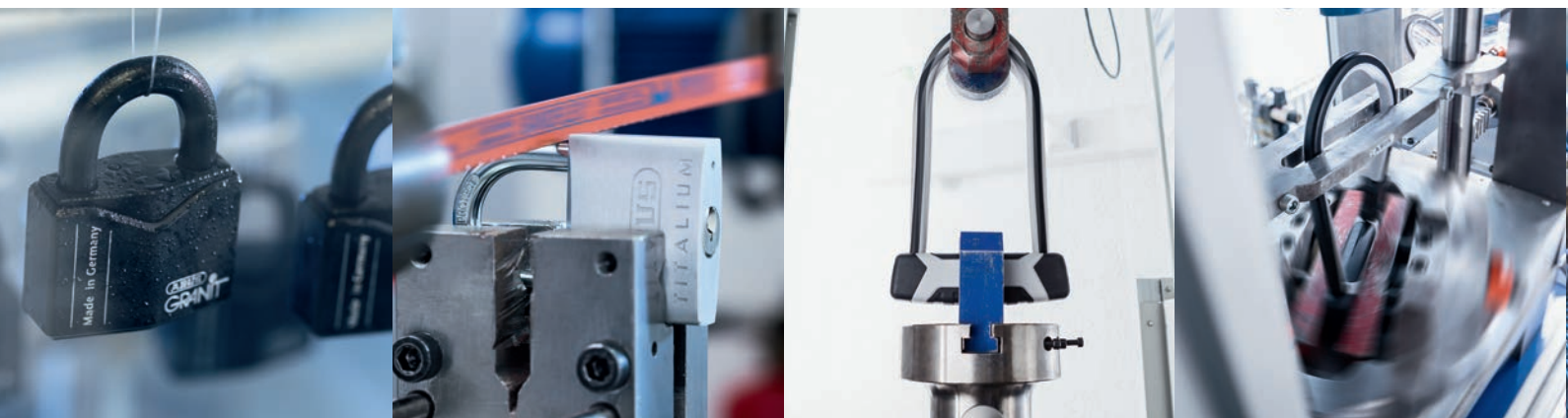

LABEL DE QUALITÉ

Les antivols ABUS sont testés et reconnus dans des instituts de contrôle indépendants et impartiaux dans de nombreux pays européens. Les labels de qualité suivants confirment le haut niveau de sécurité des antivols ABUS :



Svensk Brand- och
Säkerhetscertifiering AB
Stockholm, Sweden



Norges Forsikringsforbund
Oslo, Norway



Dansk Varefakta Naevn
Kopenhagen, Danmark



Label de qualité Finanssiala
Helsinki, Finland



ART (ANWB, RAI, Theft Insurers)
The Netherlands



Sold Secure
Rugby, Great Britain



FUB 2-roues
Valence, France



Label de qualité VdS
Cologne, Germany



ABUS-Label de qualité
der Eisspray-Prüfung
Volmarstein, Germany

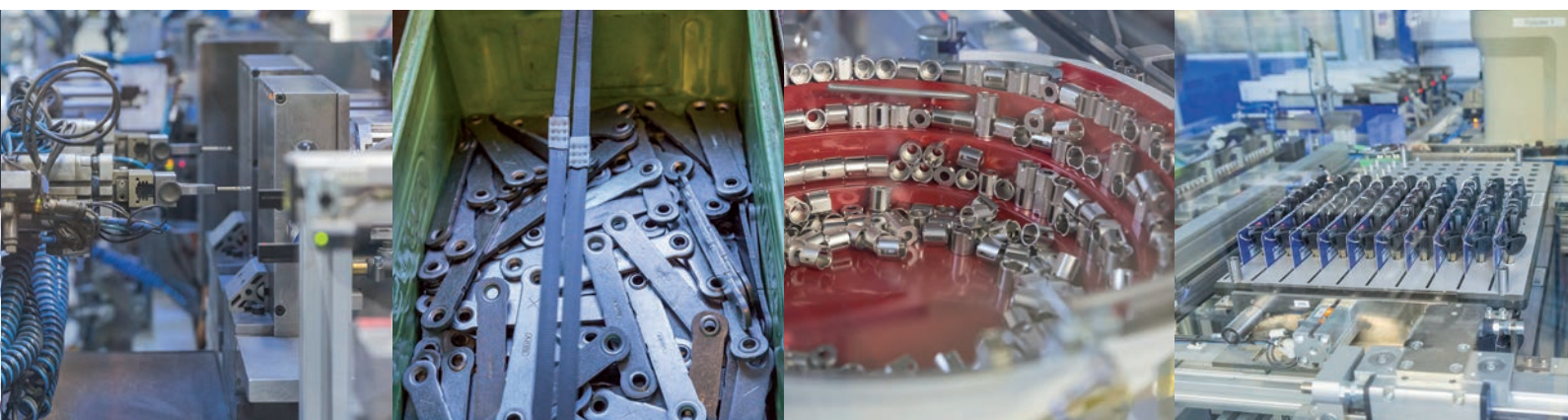



ONE KEY™ TOUT SIMPLEMENT. UNIQUE.

**FAITES FABRIQUER DES ANTIVOLS SUR-MESURE POUR VÉLOS
- FAITES TOUT FONCTIONNER AVEC UNE SEULE CLÉ !**

Un antivol pliable, un antivol de cadre, un cadenas et, pour les vélos électriques, un antivol de batterie - si vous voulez sécuriser votre vélo correctement, vous avez besoin de nombreux antivols. C'est pourquoi ABUS, avec le système ONE KEY, offre la possibilité de produire des antivols pour vos clients de telle sorte qu'ils puissent tous être actionnés avec une seule clé. Pas de désordre, pas de recherche de clés.

COMMENT FONCTIONNE ONE KEY™

C'est simple. Chaque antivol ABUS possède un code de clé individuel avec lequel il est possible de produire des clés ultérieures ou des antivols assortis, même des années après l'achat. Il suffit simplement que les antivols ABUS soient équipés du même type de cylindre.



VISAGE FAMILIER - NOUVEAU DESIGN

En tant que fabricant de cylindres et d'antivols pour vélos, ABUS a la possibilité unique sur le marché de produire des antivols individuels de manière à ce qu'ils puissent tous être utilisés avec une seule clé - C'est ce qu'on appelle le keyed alike (s'ouvrant). Il est important que les antivols soient compatibles entre eux.

Jusqu'à présent, nous avons marqué nos produits et nos campagnes avec ces icônes :



Avec YourPlus™, nous avons regroupé tous les antivols qui possèdent un cylindre Plus.

Cette icône indique actuellement que cet antivol est compatible avec le système de fermeture identique.

À PARTIR DE MAINTENANT, NOUS COMBINERONS TOUT SOUS ONE KEY™ - UNE PROMESSE CLAIRE POUR PLUS DE PRATICITÉ.

APERÇU DES PRODUITS À FERMETURE IDENTIQUE

PRODUITS AVEC CYLINDRE XPLUS

GRANIT™ Super Extreme 2500
 GRANIT™ Extreme 58
 GRANIT XPlus™ 540
 BORDO GRANIT XPlus™ 6500K
 BORDO GRANIT XPlus™ 6500KA
 BORDO™ 6000K
 BORDO™ 6000KA
 Steel-0-Chain™ 9809K
 Steel-0-Chain™ 9808K
 GRANIT City Chain XPlus™ 1060
 6950M XPlus™

PRODUITS AVEC CYLINDRE PLUS

GRANIT™ Plus 640
 GRANIT™ Plus 470
 CityChain™ 1010

CYLINDRE CE

GRANIT™ 460
 PHANTOM™ 8960

Supplément pour la fabrication de seulement 10% du prix de l'antivol.



UN CONFORT MAXIMAL POUR VOS CLIENTS

- + pas de chaos, pas de recherche de clés
- + pour les e-bikers avec antivol de batterie, cadre et cadenas
- + pour les familles avec plusieurs antivols
- + pour les couples ou les amis qui partagent leurs vélos

ARTICLES COMPATIBLES ONEKEY

ANTIVOLS EN U

| | |
|-------|----------------------------------------------------|
| 98210 | 2500/165AB230 +USH2500 gl. Granit Super Extreme |
| 95475 | 540/160HB300+SH B gl. One Key GRANIT XPLUS |
| 95474 | 540/160HB230+SH B gl. One Key GRANIT XPLUS |
| 4409 | 540/160HB300+EaZy KF gl. One Key GRANIT XPLUS |
| 4407 | 540/160HB230+EaZy KF gl. One Key GRANIT XPLUS |
| 4410 | 540/160HB300+USH540 gl. One Key GRANIT XPLUS |
| 4408 | 540/160HB230+USH540 gl. One Key GRANIT XPLUS |
| 70665 | 540/160HB300 gl. One Key GRANIT XPLUS |
| 4411 | 540/160HB230 gl. One Key GRANIT XPLUS |
| 81461 | 640/135HB230 BK TexKF gl. One Key GRANIT PLUS |
| 81460 | 640/135HB150 BK gl. One Key GRANIT PLUS |
| 81459 | 640/135HB150 BK/RD gl. One Key GRANIT PLUS |
| 95473 | 470/150HB300+SH B gl. One Key GRANIT PLUS |
| 95472 | 470/150HB230+SH B gl. One Key GRANIT PLUS |
| 81464 | 470/150HB300+EaZy KF gl. One Key GRANIT PLUS |
| 81462 | 470/150HB230+EaZy KF gl. One Key GRANIT PLUS |
| 81465 | 470/150HB300+USH gl. One Key GRANIT PLUS |
| 81463 | 470/150HB230+USH gl. One Key GRANIT PLUS |
| 95471 | 460/150HB300+SH B gl. One Key GRANIT |
| 95470 | 460/150HB230+SH B gl. One Key GRANIT |
| 4417 | 460/150HB300+USH gl. One Key GRANIT |
| 4416 | 460/150HB230+USH gl. One Key GRANIT |

ANTIVOLS PLIABLES

| | |
|-------|---------------------------------------------------|
| 67593 | 6500K/120 BK SH gl. One Key BORDO Granit XPlus |
| 91203 | 6500K/90 BK SH gl. One Key BORDO Granit XPlus |
| 64172 | 6500KA/90 BK SH gl. One Key BORDO Granit XPlus |
| 67533 | 6000K/120 BK SH gl. One Key BORDO Big |
| 67509 | 6000K/90 BK SH gl. One Key BORDO |

ANTIVOLS PLIABLES

| | |
|-------|--------------------------------------------------|
| 67464 | 6000K/120 BK ST gl. One Key BORDO Big |
| 67463 | 6000K/90 BK ST gl. One Key BORDO |
| 67614 | 6000KA/120 BK SH gl. One Key BORDO Big Alarm |
| 67608 | 6000KA/90 BK SH gl. One Key BORDO Alarm |
| 81380 | 6000/120 BK SH gl. One Key BORDO Big |
| 72987 | 6000/90 BK SH gl. One Key BORDO |
| 83747 | 6000A/120 BK SH gl. One Key BORDO Big Alarm |
| 80940 | 6000A/90 BK SH gl. One Key BORDO Alarm |
| 34572 | 5900/90 BK ST gl. One Key BORDO Classic |
| 78065 | 6055K/60 BK gl. One Key BORDO LITE MINI |
| 82573 | 6055K/60 MOVISTAR gl. One Key BORDO LITE MINI |
| 82574 | 6055K/60 RD gl. One Key BORDO LITE MINI |

CHAÎNES

| | |
|-------|-------------------------------------------|
| 42277 | 1060/170 gl. One Key City Chain XPlus |
| 42275 | 1060/140 gl. One Key City Chain XPlus |
| 30595 | 1060/110 gl. One Key City Chain XPlus |
| 42276 | 1060/85 gl. One Key City Chain XPlus |
| 21578 | 1010/170 black gl. One Key City Chain |
| 21577 | 1010/140 black gl. One Key City Chain |
| 21576 | 1010/110 black gl. One Key City Chain |
| 71549 | 1010/85 black gl. One Key City Chain |
| 95555 | 9809K/140 BK gl. One Key Steel-0-Chain |
| 95556 | 9809K/170 BK gl. One Key Steel-0-Chain |
| 95554 | 9809K/110 BK gl. One Key Steel-0-Chain |
| 95553 | 9809K/85 BK gl. One Key Steel-0-Chain |

CHAÎNES

| | |
|-------|-------------------------------------------|
| 97171 | 9808K/170 BK gl. One Key Steel-0-Chain |
| 97170 | 9808K/140 BK gl. One Key Steel-0-Chain |
| 97169 | 9808K/110 BK gl. One Key Steel-0-Chain |
| 97172 | 9808K/85 BK gl. One Key Steel-0-Chain |

STEEL-O-FLEX

| | |
|-------|---------------------------------------|
| 77088 | 8960/110 TexFL gl. One Key PHANTOM |
| 78593 | 8960/85 KF gl. One Key PHANTOM |

ANTIVOLS DE CADRE

| | |
|-------|--------------------------------------------|
| 96220 | 6950M AM NR BK OE gl. One Key XPLUS |
| 95905 | 6950M AM R BK OE gl. One Key XPLUS |
| 96218 | 6950ML NR BK OE gl. One Key XPLUS |
| 96219 | 6950ML R BK OE gl. One Key XPLUS |
| 90764 | 5955 NR BK gl. One Key PRO SHIELD XPLUS |
| 91147 | 5955 R BK gl. One Key PRO SHIELD XPLUS |
| 91145 | 5755L NR BK OE gl. One Key SHIELD XPLUS |
| 91146 | 5755L R BK OE gl. One Key SHIELD XPLUS |
| 79846 | 5950 NR BK gl. One Key PRO SHIELD |
| 87766 | 5950 R BK gl. One Key PRO SHIELD |
| 81477 | 5750L NR BK gl. One Key SHIELD PLUS |
| 81476 | 5750L R BK gl. One Key SHIELD PLUS |

SERRURES DE BATTERIES

| | |
|-------|----------------------------|
| 95510 | BLO BOS IT3 XPlus OE gl. |
| 95511 | BLO BOS IT2.1 XPlus OE gl. |
| 83447 | BLO BOS IT2.1 PLUS gl. |
| 90730 | BLO BOS DT3 XPlus OE gl. |
| 68734 | BLO BOS DT2 XPlus OE gl. |
| 81479 | BLO BOS DT2 PLUS gl. |
| 90913 | BLO BOS RT2 XPlus OE gl. |

SERRURES DE BATTERIES

| | |
|-------|-----------------------------|
| 73289 | BLO BOS RT2 PLUS gl. |
| 91226 | BLO CUB IT2.B3 XPlus OE gl. |
| 91225 | BLO CUB IT2 XPlus OE gl. |
| 96627 | BLO CUB IT2 Plus OE gl. |
| 91224 | BLO CUB IT1.B3 XPlus OE gl. |
| 91223 | BLO CUB IT1 XPlus OE gl. |
| 95514 | BLO CUB IT1 PLUS OE gl. |
| 95529 | BLO KTM IT1 XPlus OE gl. |
| 95512 | BLO SHI IT2 XPLUS OE gl. |
| 95519 | BLO SHI IT2 PLUS OE gl. |
| 83451 | BLO SHI DT1 PLUS OE gl. |
| 95521 | BLO WIN IT4 PLUS OE gl. |
| 87544 | BLO WIN IT3 PLUS OE gl. |
| 87543 | BLO WIN IT2 PLUS OE gl. |
| 87542 | BLO WIN IT1 PLUS OE gl. |
| 95520 | BLO ZEG IT5 PLUS OE gl. |
| 95513 | BLO ZEG IT4 XPlus OE gl. |
| 95517 | BLO ZEG IT4 PLUS OE gl. |
| 95516 | BLO ZEG IT3 PLUS OE gl. |

SERVICE CLÉ

Le service clé ABUS vous permet de commander directement la clé dont vous avez besoin pour vos serrures existantes.















Il suffit de choisir l'ébauche de la clé requise, de saisir ensuite le code souhaité et la clé commandée vous sera expédiée dans les plus brefs délais.

















Si aucun numéro de clé n'est disponible, veuillez nous expédier le double de la clé d'origine.

Nous pourrions produire la copie exacte de votre clé.

Pour toute demande de prix, veuillez contacter le service commercial.



| | Type de clé | Code EAN | Numéro d'article |
|-------------------------------------------------------------------------------------|--------------------------|---------------|------------------|
|  | XPlus (Clé lumineuse) | 4003318357565 | 35756 5 |
|  | XPlus | 4003318246579 | 24657 9 |
|  | Plus (Clé lumineuse) | 4003318357572 | 35757 2 |
|  | Plus | 4003318062278 | 06227 8 |
|  | 8N | 4003318816635 | 81663 5 |
|  | 6N | 4003318709777 | 70977 7 |
|  | T82 | 4003318561139 | 56113 9 |
|  | T83 | 4003318844867 | 84486 7 |
|  | F82 | 4003318815263 | 81526 3 |
|  | P82 | 4003318827044 | 82704 4 |
|  | E6 | 4003318822452 | 82245 2 |
|  | KC 54 | 4003318815270 | 81527 0 |
|  | ML54 | 4003318815287 | 81528 7 |
|  | NW52 noire | 4003318546938 | 54693 8 |

| | Type de clé | Code EAN | Numéro d'article |
|-------------------------------------------------------------------------------------|-------------------------------------------|---------------|------------------|
|  | NW72 rouge | 4003318547539 | 54753 9 |
|  | PL1 | 4003318818684 | 81868 4 |
|  | RH 5 | 4003318835957 | 83595 7 |
|  | RH EC | 4003318267666 | 26766 6 |
|  | U72 | 4003318815294 | 81529 4 |
|  | U73 | 4003318815300 | 81530 0 |
|  | U74 | 4003318815317 | 81531 7 |
|  | V61 | 4003318815324 | 81532 4 |
|  | V62 | 4003318815348 | 81534 8 |
|  | V63 | 4003318815331 | 81533 1 |
|  | V64 | 4003318815355 | 81535 5 |
|  | V65 | 4003318815362 | 81536 2 |
|  | Z72 | 4003318815379 | 81537 9 |
|  | Z73 | 4003318815386 | 81538 6 |
|  | Z74 | 4003318815393 | 81539 3 |
|  | ABUS - Bon d'achat pour clé Plus et XPlus | 4003318043185 | 04318 5 |
|  | ABUS - Bon d'achat pour d'autres clés | 4003318290015 | 29001 5 |

LE SYSTÈME DE NIVEAU ABUS

Pour trouver l'antivol qui convient à votre client, vous devez vous poser quelques questions qui peuvent vous aider dans le processus de sélection. Un antivol ne doit pas seulement être sûr, il doit aussi convenir à l'utilisateur.

Les questions ci-dessous peuvent vous aider à déterminer ce que recherche votre client :

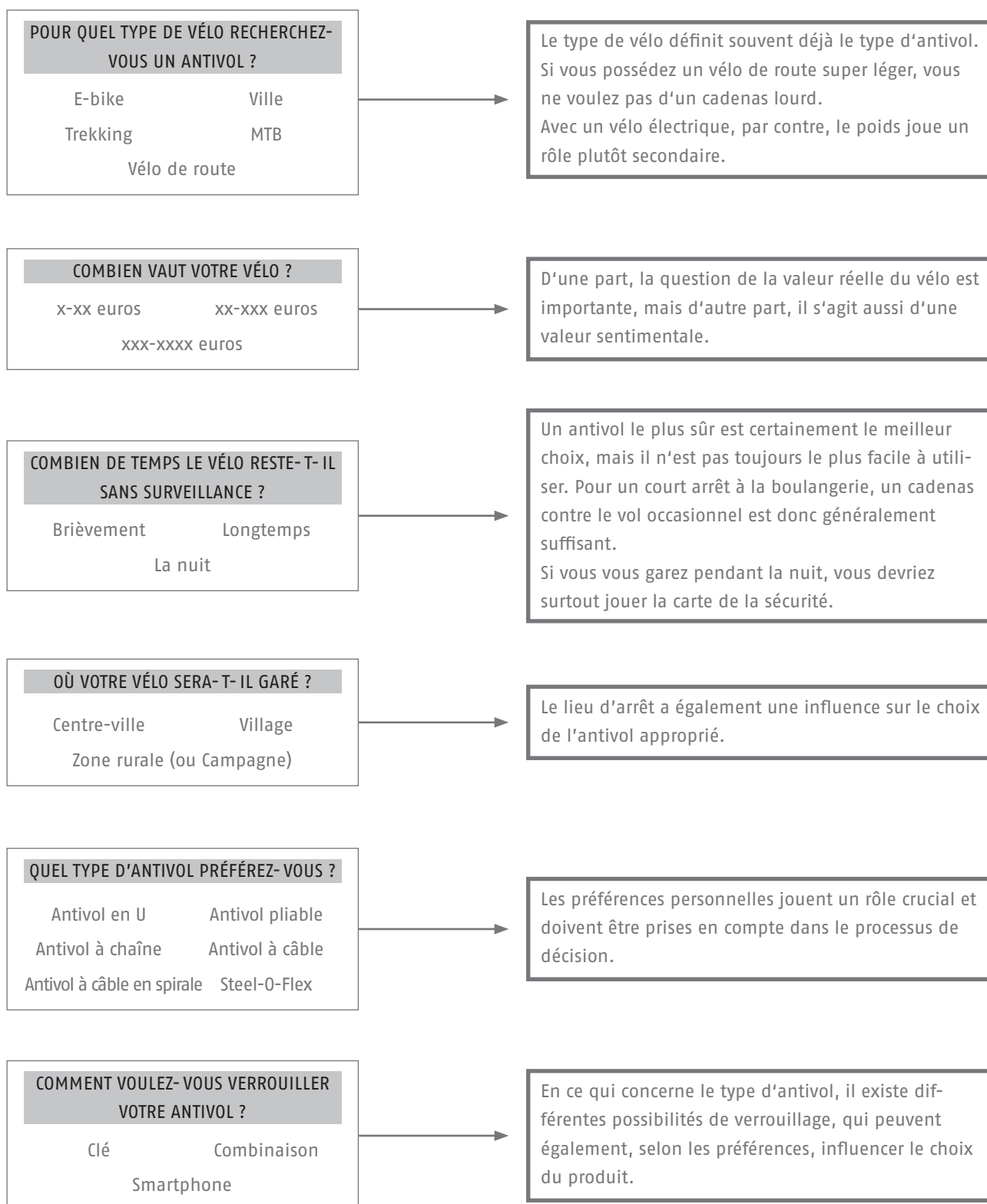

Lors d'un entretien pour une vente, vous avez un bon feeling avec votre client, et vous avez identifié son besoin. De nombreuses questions influencent le choix de l'antivol, mais pas tellement le choix du niveau de sécurité. Les facteurs les plus importants qui influencent le niveau de sécurité sont l'emplacement et la durée du stationnement.

Pour cela, nous vous recommandons le classement suivant :

| | Zone rurale  | Petite ville / village  | Centre-ville / métropole  |
|-----------------|--------------------------------------------------------------------------------------------------|--------------------------------------------------------------------------------------------------------------|-----------------------------------------------------------------------------------------------------------------|
| Arrêt court | 2 - 4 | 7 - 10 | 13 - 15 |
| Quelques heures | 5 - 6 | 10 - 13 | 13 - 15 |
| La journée | 6 - 7 | 13 - 15 | 15 |
| De nuit | 7 - 10 | 15 | 15 |

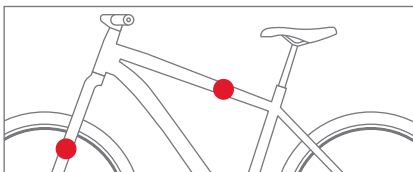

Verrouillez votre vélo dans une zone éclairée et fréquentée. Fixez votre vélo à un objet fixe et verrouillez le cadre et la roue avant. Gardez votre antivol aussi haut que possible et passez le à travers le cadre autant que vous le pouvez. L'attaque de l'antivol n'en sera que plus difficile.

ANTIVOLS EN U



GRANIT™ TM POWER 58



black

Page 16

GRANIT™ SUPER EXTREME 2500



black

Page 17

GRANIT XPLUS™ 540



black

Page 18

GRANIT™ PLUS 640



red

Page 19



black

Page 19

GRANIT™ PLUS 470



black

Page 20

ULTIMATE 420



red

Page 21

GRANIT™ 460



black

Page 22

440 ALARM



red

Page 23

ULTRA 410



green

Page 24

FACILO 32



black

Page 25

402



yellow

Page 25

GRANIT™ POWER 58

NIVEAU DE SÉCURITÉ



CARACTÉRISTIQUES



XPlus™



SH 58



Platine GIVI M6M



VARIANTES



U 58 SL

DONNÉES TECHNIQUES

- Anse de 16 mm (18 mm avec le revêtement)
- Double verrouillage de l'anse dans le boîtier, contre l'arrachement et qui oblige le voleur à couper les deux côtés de l'anse
- L'anse, le boîtier et certains éléments de fermeture sont en acier spécial cimenté
- Le cylindre ABUS X Plus offre une protection très efficace contre toute tentative de manipulation, comme le crochetaje ou le perçage
- Livré avec trois clés
- Couvercle de serrure pour protéger de la corrosion et des saletés
- Livré avec une ABUS Code Card pour la reproduction de clé
- Boîtier ouvert pour éviter la stagnation de l'eau et réduire le risque de corrosion

TECHNOLOGIE



LOGOS D'AGRÈMENT



1) class C

| Article | EAN 4003318 | mm | mm | mm | Poids g | Unité emb. |
|---------------------|----------------|-----|----|----|------------|---------------|
| 58/140HBIII310 | 32865 7 | 309 | 84 | 18 | 2580 | 2 |
| 58/140HBIII260 | 32864 0 | 259 | 84 | 18 | 2510 | 2 |
| 58/140HBIII100 | 32863 3 | 100 | 84 | 18 | 1740 | 2 |
| 58/140HB III 310 SL | 54617 4 | 310 | 84 | 18 | 2850 | 2 |
| 58/140HB III 260 SL | 54616 7 | 260 | 84 | 18 | 2510 | 2 |
| 58/140HB III 230 SL | 57164 0 | 230 | 84 | 18 | 2370 | 2 |
| 58/140HB III 210 SL | 57163 3 | 210 | 84 | 18 | 2270 | 2 |
| 58/140HB III 100 SL | 57149 7 | 100 | 84 | 18 | 1740 | 2 |
| SH 58 | 05810 3 | | | | | 3 |

GRANIT™ SUPER EXTREME 2500

NEW

Antivol en U

NIVEAU DE SÉCURITÉ



CARACTÉRISTIQUES



USH2500



DONNÉES TECHNIQUES



- Anse parabolique carrée cémentée de 20 mm avec revêtement PVC de 7 mm
- L'anse et le corps de l'antivol sont mieux protégés contre les attaques brutales à la scie avec des meuleuses d'angle grâce à un mélange spécial de carbure
- Double verrouillage de l'anse dans le corps de l'antivol
- L'anse, le boîtier et les éléments porteurs du mécanisme de verrouillage sont fabriqués en acier spécialement cémenté
- Cylindre ABUS XPlus™ pour une protection extrêmement élevée contre les manipulations, par ex. le picking
- La technologie ABUS Power Cell offre une protection maximale contre les coups et les attaques d'accès
- Deux clés incluses dans l'emballage
- ABUS Code Card pour les clés de rechange ou les clés supplémentaires
- Support USH 2500, convient comme solution de transport sur le porte-bagages, la structure arrière du vélo, etc.
- Montage simplifié de l'USH 2500, car le support peut pivoter axialement pour être fixé
- Livré avec support et bandes de serrage métalliques

TECHNOLOGIE



LOGOS D'AGRÈMENT



| Article | EAN 4003318 |  mm |  mm |  mm | Poids g | Unité emb. |
|-------------------------|----------------|-------------------------------------------------------------------------------------------|-------------------------------------------------------------------------------------------|--------------------------------------------------------------------------------------------|---------|------------|
| 2500/165HB230 | 99680 1 | 102 | 230 | 27 | 2200 | 1 |
| 2500/165HB230 + USH2500 | 96050 5 | 102 | 230 | 27 | 2520 | 1 |

GRANIT™ XPLUS™ 540

NIVEAU DE SÉCURITÉ



CARACTÉRISTIQUES

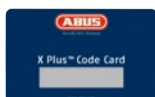

XPlus™



USH 540



SH B



DONNÉES TECHNIQUES

- Anse cémentée parabolique carrée de 13 mm de diamètre: sécurité brevetée
- ABUS Power Cell (breveté) offre une protection très élevée contre toute tentative de manipulation, comme le crochetage
- L'anse, le boîtier et certains éléments de fermeture sont en acier spécial cémenté
- Le cylindre ABUS XPlus offre une protection très efficace contre toute tentative de manipulation, comme le crochetage
- Cache de serrure pour protéger de la corrosion et des saletés

TECHNOLOGIE



LOGOS D'AGRÈMENT



1) 30330

| Article | EAN 4003318 | | | | Poids g | Unité emb. |
|-----------------------|----------------|-----|-----|----|---------|------------|
| | | mm | mm | mm | | |
| 540/160HB230 | 11161 7 | 108 | 230 | 17 | 1500 | 6 |
| 540/160HB300 | 11179 2 | 108 | 300 | 17 | 1700 | 6 |
| 540/160HB230 + USH540 | 11186 0 | 108 | 230 | 17 | 1650 | 5 |
| 540/160HB300 + USH540 | 11188 4 | 108 | 300 | 17 | 1850 | 5 |
| 540/160HB230 + SH B | 69076 1 | 108 | 230 | 17 | 1650 | 3 |
| 540/160HB300 + SH B | 69075 4 | 108 | 300 | 17 | 1850 | 3 |

GRANIT™ PLUS 640

NIVEAU DE SÉCURITÉ



CARACTÉRISTIQUES



Plus



Support TexKF Mini



VARIANTES



HB150 black



HB230 black

DONNÉES TECHNIQUES

- Anse ronde en acier cémenté de 12 mm de diamètre
- L'anse, le boîtier et certains éléments de fermeture sont en acier spécial cémenté
- Optimisation de la sécurité et du poids grâce à l'emploi de matériaux très légers
- Cylindre ABUS Plus pour une protection élevée contre toute tentative de manipulation, comme le crochetage

TECHNOLOGIE



LOGOS D'AGRÈMENT



1) seulement pour (Art.-Nr. 72510) 2) 31644

| Article | EAN 4003318 | | | | Poids g | Unité emb. |
|----------------------------|----------------|----|-----|----|---------|------------|
| | | mm | mm | mm | | |
| 640/135HB150 red | 39704 2 | 83 | 150 | 15 | 800 | 4 |
| 640/135HB150 black | 39702 8 | 83 | 150 | 15 | 800 | 4 |
| 640/135HB230 + TexKF black | 39703 5 | 83 | 230 | 15 | 1030 | 6 |

GRANIT™ PLUS 470

NIVEAU DE SÉCURITÉ



CARACTÉRISTIQUES

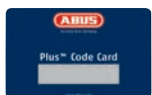

Plus



USH 460/470/32



SH B

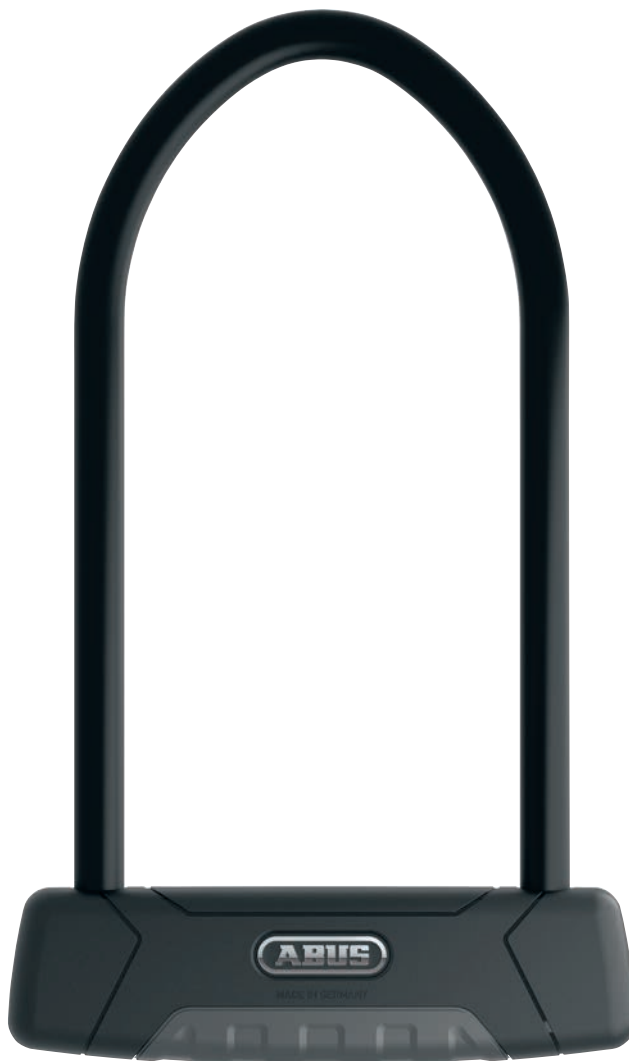

DONNÉES TECHNIQUES

- Anse cémentée parabolique de 12 mm de diamètre
- ABUS Power Cell (breveté) offre une protection très élevée contre toute tentative de manipulation, comme le crochitage
- L'anse, le boîtier et certains éléments de fermeture sont en acier spécial cémenté
- Cache de serrure pour protéger de la corrosion et des saletés

TECHNOLOGIE



LOGOS D'AGRÈMENT



1) 30328

| Article | EAN 4003318 | | | | Poids g | Unité emb. |
|-----------------------|----------------|-----|-----|----|---------|------------|
| | | mm | mm | mm | | |
| 470/150HB230 + USH470 | 11249 2 | 109 | 230 | 14 | 1260 | 4 |
| 470/150HB300 + USH470 | 11251 5 | 109 | 300 | 14 | 1320 | 5 |
| 470/150HB230 + SH B | 69073 0 | 109 | 230 | 14 | 1290 | 4 |
| 470/150HB300 + SH B | 69072 3 | 109 | 300 | 14 | 1350 | 4 |

ULTIMATE 420

NIVEAU DE SÉCURITÉ



CARACTÉRISTIQUES



USH



DONNÉES TECHNIQUES

- Anse ronde en acier cémenté de 13 mm de diamètre
- L'anse, le boîtier et les éléments du mécanisme de verrouillage sont en acier spécial cémenté
- La forme ergonomique permet une meilleure manipulation
- Cylindre premium pour une protection élevée contre toute tentative de manipulation, comme le crochetage



TECHNOLOGIE



LOGOS D'AGRÉMENT



1) 33241

| Article | EAN 4003318 |  mm |  mm |  mm | Poids g | Unité emb. |
|--------------------------------------|----------------|-------------------------------------------------------------------------------------------|-------------------------------------------------------------------------------------------|--------------------------------------------------------------------------------------------|---------|------------|
| 420/150HB140 + USH Ultimate | 81689 5 | 80 | 140 | 17 | 900 | 6 |
| 420/170HB230 + USH Ultimate | 39631 1 | 100 | 230 | 17 | 1100 | 6 |
| 420/150HB140 + USH + 10/120 Ultimate | 81969 8 | 80 | 140 | 17 | 1240 | 6 |
| 420/170HB230 + USH + 10/120 Ultimate | 39633 5 | 100 | 230 | 17 | 1440 | 6 |

GRANIT™ 460

NIVEAU DE SÉCURITÉ



CARACTÉRISTIQUES



USH 460/470/32



SH B



DONNÉES TECHNIQUES

- Anse cémentée parabolique de 12 mm de diamètre
- L'anse, le boîtier et certains éléments de fermeture sont en acier spécial cémenté
- Cylindre ABUS Extra-Classe

TECHNOLOGIE



LOGOS D'AGRÈMENT



| Article | EAN 4003318 | | | | Poids g | Unité emb. |
|-----------------------|----------------|-----|-----|----|---------|------------|
| | | mm | mm | mm | | |
| 460/150HB230 + USH460 | 11253 9 | 109 | 230 | 14 | 1000 | 4 |
| 460/150HB300 + USH460 | 11255 3 | 109 | 300 | 14 | 1250 | 5 |
| 460/150HB230 + SH B | 69070 9 | 109 | 230 | 14 | 1050 | 3 |
| 460/150HB300 + SH B | 69071 6 | 109 | 300 | 14 | 1300 | 3 |

440 ALARM

NIVEAU DE SÉCURITÉ



CARACTÉRISTIQUES



USH



DONNÉES TECHNIQUES



- Anse ronde en acier cémenté de 12 mm de diamètre
- L'anse, le boîtier et les éléments du mécanisme de verrouillage sont en acier spécial cémenté
- La forme ergonomique permet une meilleure manipulation
- Cylindre premium pour une protection élevée contre toute tentative de manipulation, comme le crochetage
- Alarme de 100 dB pendant 15 secondes
- Alarme intelligente - Système de détection 3D qui détecte les chocs et les mouvements
- Une pile CR2 incluse

TECHNOLOGIE



LOGOS D'AGRÈMENT



| Article | EAN 4003318 |  mm |  mm |  mm | Poids g | Unité emb. |
|-------------------------|----------------|-------------------------------------------------------------------------------------------|-------------------------------------------------------------------------------------------|--------------------------------------------------------------------------------------------|---------|------------|
| 440A/150HB160 USH Alarm | 82605 4 | 85 | 160 | 14 | 1100 | 6 |
| 440A/170HB230 USH Alarm | 82606 1 | 108 | 230 | 14 | 1500 | 6 |

ULTRA 410

NIVEAU DE SÉCURITÉ



CARACTÉRISTIQUES



Support USH 34

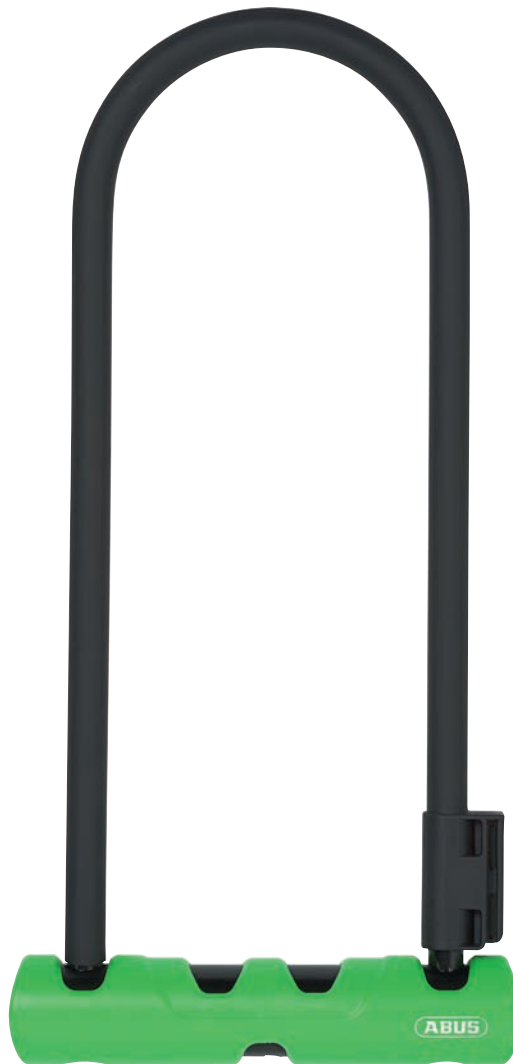

VARIANTES



410/150HB140



410/150HB140 + 10/120



410/150HB180 + 10/120

DONNÉES TECHNIQUES



- Anse ronde en acier cémenté de 12 mm de diamètre
- L'anse, le boîtier et certains éléments de fermeture sont en acier spécial cémenté
- Forme ergonomique pour une meilleure prise en main
- Cylindre premium pour une protection très efficace contre toute tentative de manipulation, comme le crochetage

TECHNOLOGIE



LOGOS D'AGRÈMENT



| Article | EAN 4003318 |  mm |  mm |  mm | Poids g | Unité emb. |
|----------------------------------------------|----------------|-------------------------------------------------------------------------------------------|-------------------------------------------------------------------------------------------|--------------------------------------------------------------------------------------------|------------|------------|
| 410/150HB140 green SH34 | 34594 4 | 80 | 140 | 14 | 755 | 6 |
| 410/150HB140 green SH34 + Cobra 10/120 | 34596 8 | 80 | 140 | 14 | 755 + 340 | 6 |
| 410/150HB180 green SH34 + Cobra 10/120 | 34597 5 | 80 | 180 | 14 | 835 + 340 | 6 |
| 410/170HB230 green SH34 Ultra | 34591 3 | 110 | 230 | 14 | 1000 | 6 |
| 410/170HB230 green SH34 Ultra + Cobra 10/120 | 34590 6 | 110 | 230 | 14 | 1000 + 340 | 6 |

FACILO 32

CARACTÉRISTIQUES



USH 460/470/32

NIVEAU DE SÉCURITÉ



DONNÉES TECHNIQUES



- Anse ronde en acier cémenté de 12 mm de diamètre
- Equipé d'un cylindre de qualité ABUS
- Recouvert d'un gainage PVC pour protéger le vernis du vélo

TECHNOLOGIE



LOGOS D'AGRÈMENT



| Article | EAN 4003318 |  mm |  mm |  mm | Poids g | Unité emb. |
|---------------------|----------------|-----------------------------------------------------------------------------------------|-----------------------------------------------------------------------------------------|------------------------------------------------------------------------------------------|---------|------------|
| 32/150HB230 + USH32 | 37492 0 | 109 | 230 | 15 | 950 | 6 |
| 32/150HB300 + USH32 | 37887 4 | 109 | 300 | 15 | 1160 | 6 |

402

CARACTÉRISTIQUES



Support USH 34

NIVEAU DE SÉCURITÉ



LOGOS D'AGRÈMENT





DONNÉES TECHNIQUES

- Anse ronde trempée de 11 mm
- Double verrouillage de l'anse dans le corps de l'antivol
- L'anse, le boîtier et les pièces de support du mécanisme de verrouillage sont fabriqués en acier spécialement cémenté
- La conception spéciale et moderne du boîtier du corps de l'antivol permet une manipulation optimale
- Cylindre de fermeture de haute qualité pour la protection contre la manipulation, par exemple le crochetage
- Quatre clés incluses

TECHNOLOGIE



| Article | EAN 4003318 |  mm |  mm |  mm | Poids g | Unité emb. |
|--------------------------|----------------|-------------------------------------------------------------------------------------------|-------------------------------------------------------------------------------------------|--------------------------------------------------------------------------------------------|---------|------------|
| 402/170HB230 yellow SH34 | 86742 2 | 110 | 230 | 11 | 890 | 6 |

ANTIVOLS PLIABLES

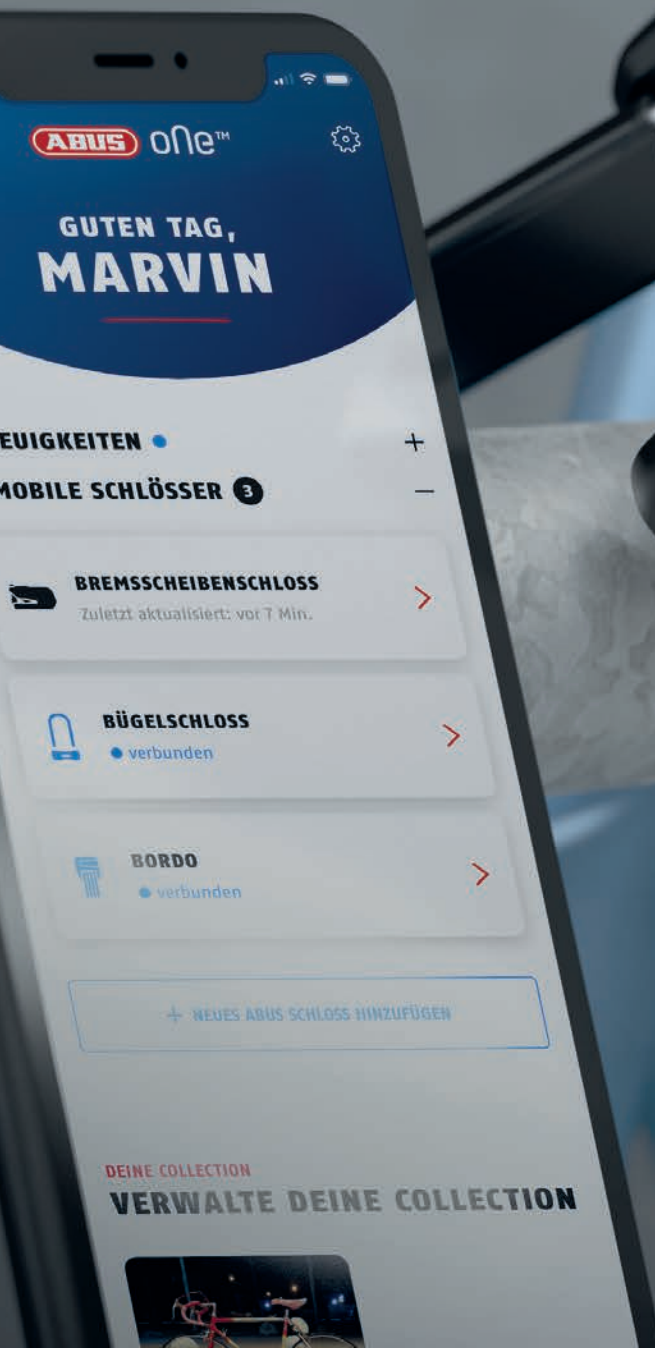

**BORDO™
6500A SMARTX**



6500A/110
black
Page 30

**BORDO GRANIT™
6500KA**



6500KA/90
black
Page 31

**BORDO GRANIT™
6500K**



6500K/90
black
Page 32



6500K/120
black
Page 32

**BORDO™
6000A SMARTX**



6000A
black
Page 33



**BORDO™
6000KA**



6000KA/90
black
Page 34



6000KA/120
black
Page 34

**BORDO™
6000K**



6000K/90
black
Page 35



6000K/120
black
Page 35

**BORDO™
6000C**



6000C/90
black
Page 36

**BORDO™
6000C LED**

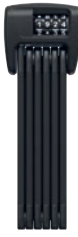

6000C/90 LED
black
Page 37

**UGRIP BORDO™
5700K**



black
Page 38



lime
Page 38

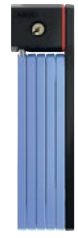

blue
Page 38



red
Page 38

**UGRIP BORDO™
5700C**



red
Page 39



black
Page 39

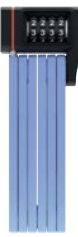

blue
Page 39

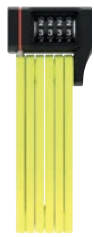

lime
Page 39

**BORDO™
LITE 6055K**



Movistar Team

Page 40



black

Page 40



red

Page 40

**BORDO™
LITE 6055C**



black

Page 41



red

Page 41



Movistar Team

Page 41



pink SYMBOLS

Page 41



blue SYMBOLS

Page 41



ABUS

BORDO™ 6500A SMARTX

NIVEAU DE SÉCURITÉ



CARACTÉRISTIQUES



Support SH BORDO
6500A SmartX



SmartX RC



Compatible
avec un smartphone
iOS et Android ou une
télécommande Smart RC
(vendue séparément)

DONNÉES TECHNIQUES

- Barres articulées de 5,5 mm d'épaisseur, avec revêtement extra souple à 2 composants
- Utilisation simple via l'application ABUS One (auparavant SmartX) - pour iOS et Android
- Ouverture et fermeture de l'antivol vélo sans clé – fonction Keyless basée sur la technologie éprouvée ABUS SmartX™ Bluetooth®
- Fonction alarme avec 100 dB au min. pendant 15 secondes, puis réarmement automatique
- Détection des positions 3D – elle détecte les vibrations et les mouvements dans les trois dimensions et déclenche l'alarme
- Alarme intelligente – en cas de petits chocs brefs, par exemple un ballon de football, l'antivol n'émet qu'un bref signal sonore d'avertissement
- Port USB-C
- Mémorisation de l'emplacement du dernier stationnement du vélo
- La lumière LED indique l'état de la pile et de la charge
- Également utilisable avec la télécommande fournie (prendre variante RC)
- Support inclus (SH)

TECHNOLOGIE



LOGOS D'AGRÈMENT



| Article | EAN 4003318 | cm | Poids g | Unité emb. |
|-------------------------------|----------------|--------|---------|------------|
| 6500A/110 black SH SmartX™ | 61495 8 | 110 | 2300 | 3 |
| 6500A/110 black SH RC SmartX™ | 61497 2 | 110 | 2320 | 3 |
| Support SH 6500A SmartX™ | 63488 8 | | 148 | 1 |
| SmartX™ RC | 64000 1 | | 70 | 1 |

BORDO GRANIT™ 6500KA

NIVEAU DE SÉCURITÉ



CARACTÉRISTIQUES



Support SH 6500K/90



Antivolis pliables

DONNÉES TECHNIQUES

- Barres articulées de 5,5 mm d'épaisseur avec revêtement extra-souple pour protéger contre les dommages à la peinture
- Les barres et le boîtier sont en acier spécialement trempé
- Fonction alarme avec au moins 100 dB pendant 15 secondes et réactivation automatique subséquente
- Détection d'alarme positionnelle en 3-D - détecte les chocs et les mouvements dans toutes les dimensions
- Alarme intelligente - l'antivol n'émet qu'un petit signal sonore en cas de chocs faibles et courts, par exemple si un ballon de football heurte le vélo
- (ABUS Link Protection Shield) pour une protection élevée contre les attaques sur les articulations
- Avec support (SH)
- Cylindre ABUS XPlus pour une protection extrêmement élevée contre le vol, par exemple le crochetage
- Des signaux sonores indiquent l'état de la pile et de l'activité
- Position de transport - ne pas insérer complètement la barre de fermeture, l'alarme est alors inactive
- Position d'alarme - insérer complètement la barre de fermeture, puis l'alarme est armée après le verrouillage
- Haut-parleur avec peu de surface de contact - protégé derrière la barre de fermeture
- Comprend un support d'antivol SH pour le transport sur le vélo

TECHNOLOGIE



LOGOS D'AGRÈMENT



| Article | EAN 4003318 |  cm | Poids g | Unité emb. |
|--------------------|----------------|-------------------------------------------------------------------------------------------|---------|------------|
| 6500KA/90 black SH | 69052 5 | 90 | 2020 | 3 |
| SH 6500K/90 | 69051 8 | | 195 | 3 |

BORDO GRANIT™ 6500K

NIVEAU DE SÉCURITÉ



CARACTÉRISTIQUES



Support SH 6500K/90



VARIANTES



6500K/90 Twinset



6500K/120

DONNÉES TECHNIQUES

- Barres articulées de 5,5 mm d'épaisseur avec revêtement extra-souple pour protéger contre les dommages à la peinture
- Les barres, le boîtier ainsi que les pièces de support de l'élément de fermeture sont fabriqués en acier spécialement trempé
- Le (Link-Protection-Shield) d'ABUS offre une protection élevée au niveau des articulations
- Cylindre ABUS XPlus pour une protection extrêmement élevée contre le vol, par exemple le crochetage
- Cet antivol peut être fabriqué avec une clé identique à celle d'une variété d'autres antivols
- Comprend un support d'antivol SH pour le transport sur le vélo

TECHNOLOGIE



LOGOS D'AGRÈMENT



1) 37547

| Article | EAN 4003318 |  cm | Poids g | Unité emb. |
|---------------------------|----------------|-------------------------------------------------------------------------------------------|-----------------|------------|
| 6500K/90 black SH | 61498 9 | 90 | 1670 | 4 |
| 6500K/90 black SH TwinSet | 61499 6 | 90 | 1670 je Schloss | 2 |
| 6500K/120 black SH | 62115 4 | 120 | 2470 | 4 |
| Support SH 6500K/90 | 69051 8 | | 195 | 3 |
| Support SH 6500K/120 | 96279 0 | | 230 | 3 |

BORDO™ ONE 6000A

NEW

Antivolis pliables

NIVEAU DE SÉCURITÉ



CARACTÉRISTIQUES



Support SH 6000/120



SmartX RC



DONNÉES TECHNIQUES

- Barres articulées de 5 mm d'épaisseur avec revêtement extra souple à 2 composants
- Utilisation simple via l'application ABUS One – pour iOS et Android
- Technologie SmartX sécurisée avec intégration dans ABUS One
- Intégration simple et sûre de plusieurs utilisateurs/smartphones
- Fonction alarme avec 100 dB au min. pendant 15 secondes, puis réarmement automatique
- Détection des positions 3D – elle détecte les vibrations et les mouvements dans les trois dimensions et déclenche l'alarme
- Alarme intelligente – en cas de petits chocs brefs, par exemple un ballon de football, etc., l'antivol n'émet qu'un bref signal sonore d'avertissement
- Port USB-C
- Mémorisation de l'emplacement du dernier stationnement du vélo
- Affichage de l'état par LED
- Dans la variante RC, également utilisable avec une télécommande
- Support inclus (SH)
- Pile CR123A

TECHNOLOGIE



| Article | EAN 4003318 |  cm | Poids g | Unité emb. |
|----------------------------|----------------|-------------------------------------------------------------------------------------------|---------|------------|
| 6000A/120 BK SH SmartX™ | 97338 3 | 120 | 1760 | 1 |
| 6000A/120 BK SH RC SmartX™ | 97339 0 | 120 | 1760 | 1 |
| Support SH 6000/120 | 61564 1 | | 132 | 3 |
| SmartX™ RC | 64000 1 | | 70 | 1 |

BORDO™ 6000KA

NIVEAU DE SÉCURITÉ



CARACTÉRISTIQUES

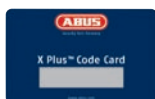

XPlus™



Support SH 6000/90



Support SH 6000/120



VARIANTES



6000KA/120 BK SH

DONNÉES TECHNIQUES

- Barres articulées de 5 mm d'épaisseur avec un revêtement extra souple et en même temps résistant pour protéger contre les dommages causés par la peinture
- Les barres et le boîtier sont en acier spécialement trempé
- Fonction alarme avec min. 100 dB pendant 20 secondes, puis réarmement automatique
- Détection de position 3D - détecte les vibrations et les moindres mouvements dans les trois dimensions et déclenche l'alarme
- Alarme intelligente - en cas de vibrations légères et brèves, par exemple avec un ballon de football, etc., l'antivol n'émet qu'un bref signal sonore
- Des signaux sonores indiquent l'état de la pile et de l'activité
- Connexion des barres articulées par des rivets spéciaux
- Cylindre ABUS XPlus pour une protection extrêmement élevée contre le vol, par exemple le crochetage
- Support SH inclus
- Position de transport - ne pas insérer complètement la barre de fermeture, l'alarme est alors inactive
- Position d'alarme - insérer complètement la barre de fermeture, puis l'alarme est armée après le verrouillage
- Haut-parleur avec peu de surface de contact - protégé derrière la barre de fermeture

TECHNOLOGIE



LOGOS D'AGRÈMENT



| Article | EAN 4003318 |  cm | Poids g | Unité emb. |
|---------------------|----------------|-------------------------------------------------------------------------------------------|---------|------------|
| 6000KA/90 black SH | 61500 9 | 90 | 1450 | 4 |
| 6000KA/120 black SH | 62090 4 | 120 | 1700 | 4 |
| Support SH 6000/90 | 61543 6 | | 115 | 3 |
| Support SH 6000/120 | 61564 1 | | 132 | 3 |

BORDO™ 6000K

NIVEAU DE SÉCURITÉ



CARACTÉRISTIQUES

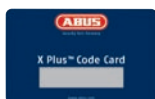

XPlus™



Support SH 6000/90



Support SH SF 6000/90



Support SH 6000/120



VARIANTES



6000K/120

Antivolis pliables

DONNÉES TECHNIQUES

- Barres articulées de 5 mm d'épaisseur avec un revêtement extra souple et en même temps résistant pour protéger contre les dommages causés par la peinture
- Les barres et le boîtier sont fabriqués en acier spécialement trempé
- Connexion des barres par des rivets spéciaux
- Cylindre ABUS XPlus pour une protection extrêmement élevée contre la manipulation, par exemple le prélèvement

TECHNOLOGIE



LOGOS D'AGRÈMENT



| Article | EAN 4003318 |  cm | Poids g | Unité emb. |
|----------------------------|----------------|-------------------------------------------------------------------------------------------|---------|------------|
| 6000K/90 black SH | 62094 2 | 90 | 1330 | 4 |
| 6000K/90 black SH TwinSet | 62095 9 | 90 | 1330 | 2 |
| 6000K/90 black SH SF | 67865 3 | 90 | 1330 | 4 |
| 6000K/90 black SHFL | 90973 3 | 90 | 1330 | 4 |
| 6000K/120 black SH | 62091 1 | 120 | 1546 | 4 |
| 6000K/120 black SH TwinSet | 67465 5 | 120 | 1546 | 2 |
| Support SH 6000/90 | 61543 6 | | 115 | 3 |
| Support SH SF | 67866 0 | | 121 | 3 |
| Support SH 6000/120 | 61564 1 | | 132 | 3 |
| Support SHFL 6000/90 | 88886 1 | | 160 | 3 |

BORDO™ 6000C

NIVEAU DE SÉCURITÉ



CARACTÉRISTIQUES



Support SH 6000/90



Support SH SF 6000/90



Support SHFL 6000/90

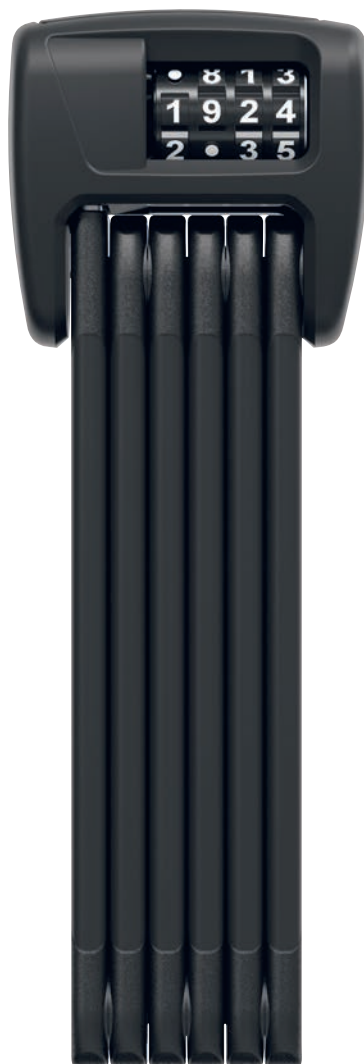

DONNÉES TECHNIQUES

- Barres articulées de 5 mm d'épaisseur avec un revêtement extra souple et en même temps résistant pour protéger contre les dommages causés par la peinture
- Les barres et le boîtier sont fabriqués en acier spécialement trempé
- Connexion des barres par des rivets spéciaux
- Les molettes à 2 composantes assurent une lisibilité permanente des numéros
- Code à chiffres réglable individuellement
- Support SH inclus

TECHNOLOGIE



LOGOS D'AGRÈMENT



| Article | EAN 4003318 |  cm | Poids g | Unité emb. |
|----------------------|----------------|-------------------------------------------------------------------------------------------|---------|------------|
| 6000C/90 black SH | 67599 7 | 90 | 1050 | 4 |
| 6000C/90 black SH SF | 69069 3 | 90 | 1170 | 4 |
| 6000C/90 black SHFL | 90972 6 | 90 | 1050 | 1 |
| Support SH 6000/90 | 61543 6 | | 115 | 3 |
| Support SHFL 6000/90 | 88886 1 | | 160 | 3 |
| Support SH SF | 67866 0 | | 121 | 3 |

BORDO™ 6000C LED

NIVEAU DE SÉCURITÉ



CARACTÉRISTIQUES



LED



Support SH 6000/90



Support SHFL 6000/90

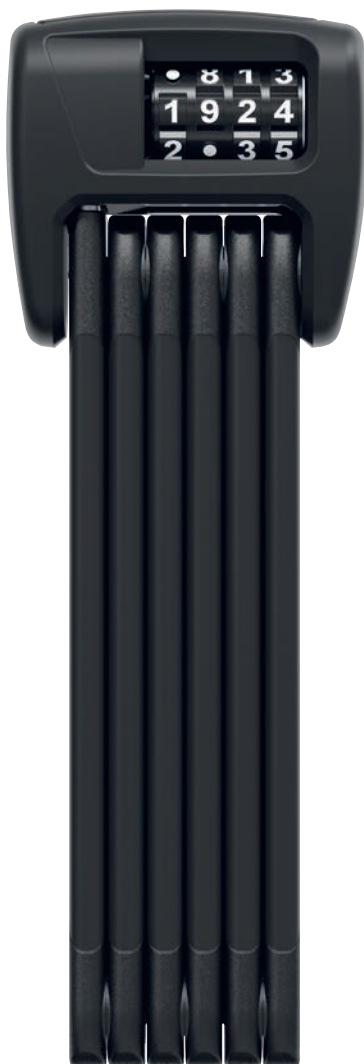

Antivois pliables

DONNÉES TECHNIQUES

- Barres articulées de 5 mm d'épaisseur avec revêtement extra souple pour protéger contre les dommages causés par la peinture
- Les barres et le boîtier sont fabriqués en acier spécialement trempé
- Connexion des barres par des rivets spéciaux
- Lampe LED intégrée pour l'éclairage des molettes
- Une pile bouton CR1220 pour alimenter la lampe LED est incluse
- Les molettes à 2 composantes assurent une lisibilité permanente des numéros
- Code à chiffres réglable individuellement
- Support SH inclus

TECHNOLOGIE



LOGOS D'AGRÈMENT



| Article | EAN 4003318 |  cm | Poids g | Unité emb. |
|-----------------------|----------------|-------------------------------------------------------------------------------------------|---------|------------|
| 6000C/90 LED black SH | 69057 0 | 90 | 1050 | 4 |
| Support SH 6000/90 | 61543 6 | | 115 | 3 |
| Support SHFL 6000/90 | 88886 1 | | 160 | 3 |

UGRIP BORDO™ 5700K

NIVEAU DE SÉCURITÉ



CARACTÉRISTIQUES



Support SH 5700/80



Support SH 5700K/100



VARIANTES



5700K/100 lime



5700K/80 lime



5700K/100 blue



5700K/80 blue



5700K/100 red



5700K/80 red



5700K/100 black

DONNÉES TECHNIQUES

- Barres articulées en acier de 5 mm
- Les articulations sont reliées entre elles par des rivets spéciaux
- Cylindre automatique premium
- Le mode de transport pratique (CTM) fournit une utilisation immédiate de l'antivol (uniquement pour 5700/100)

TECHNOLOGIE



LOGOS D'AGRÈMENT



| Article | EAN 4003318 | cm | Poids g | Unité emb. |
|----------------------|----------------|--------|---------|------------|
| 5700K/80 black SH | 84425 6 | 80 | 960 | 6 |
| 5700K/80 lime SH | 84427 0 | 80 | 960 | 6 |
| 5700K/80 blue SH | 84426 3 | 80 | 960 | 6 |
| 5700K/80 red SH | 84428 7 | 80 | 960 | 6 |
| 5700K/100 black SH | 86743 9 | 100 | 1090 | 6 |
| 5700K/100 lime SH | 86745 3 | 100 | 1090 | 6 |
| 5700K/100 blue SH | 86744 6 | 100 | 1090 | 6 |
| 5700K/100 red SH | 86746 0 | 100 | 1090 | 6 |
| Support SH 5700/80 | 61566 5 | | 122 | 3 |
| Support SH 5700K/100 | 61571 9 | | 122 | 3 |

UGRIP BORDO™ 5700 COMBO

NIVEAU DE SÉCURITÉ



CARACTÉRISTIQUES



SH 5700/80

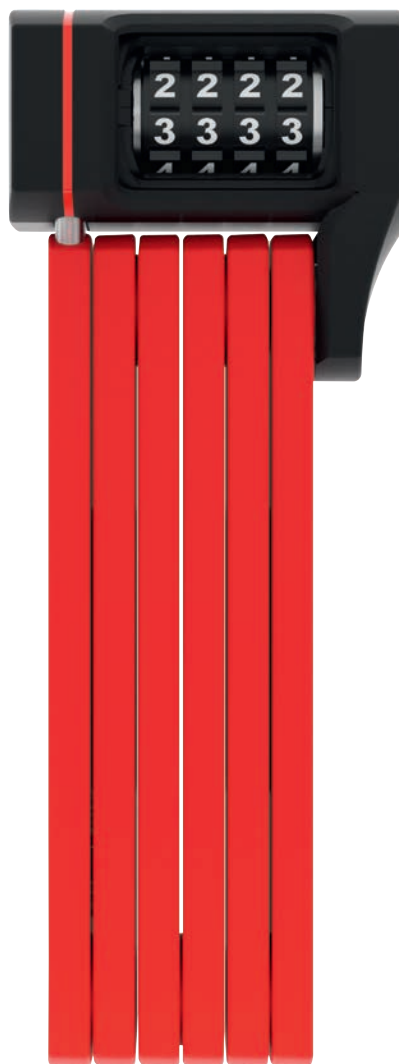

VARIANTES



5700C/80 black



5700C/80 blue



5700C/80 lime

Antivolis pliables

DONNÉES TECHNIQUES

- Barres articulées en acier de 5 mm
- Les articulations sont reliées entre elles par des rivets spéciaux
- Les molettes à 2 composants assurent une lisibilité permanente de numéros
- Programmation individuelle du code

TECHNOLOGIE



LOGOS D'AGRÈMENT



| Article | EAN 4003318 |  cm | Poids g | Unité emb. |
|--------------------|----------------|-------------------------------------------------------------------------------------------|---------|------------|
| 5700C/80 black SH | 87791 9 | 80 | 960 | 6 |
| 5700C/80 blue SH | 87792 6 | 80 | 960 | 6 |
| 5700C/80 lime SH | 87793 3 | 80 | 960 | 6 |
| 5700C/80 red SH | 87794 0 | 80 | 960 | 6 |
| Support SH 5700/80 | 61566 5 | | 122 | 3 |

BORDO™ LITE 6055K

NIVEAU DE SÉCURITÉ



CARACTÉRISTIQUES



Support SH 6055



Support SR 6055



VARIANTES



black



black



red



red

DONNÉES TECHNIQUES

- Barres articulées en acier léger de 5 mm recouvertes d'un gainage pour une bonne protection de la peinture du vélo
- Les articulations et le boîtier sont fabriqués dans un matériau très léger et composés d'acier
- Les articulations sont reliées entre elles par des rivets
- Cylindre de qualité premium
- Le BORDO Lite Mini se range facilement dans les poches de votre maillot

TECHNOLOGIE



LOGOS D'AGRÈMENT



| Article | EAN 4003318 | cm | Poids g | Unité emb. |
|------------------------|----------------|----|---------|------------|
| 6055K/60 black | 78060 8 | 60 | 400 | 6 |
| 6055K/60 black SH | 62102 4 | 60 | 500 | 6 |
| 6055K/60 black SR | 62103 1 | 60 | 500 | 4 |
| 6055K/60 red | 78061 5 | 60 | 400 | 6 |
| 6055K/60 MOVISTAR TEAM | 78062 2 | 60 | 400 | 6 |
| 6055K/85 black SH | 78063 9 | 85 | 550 | 6 |
| 6055K/85 black SR | 62104 8 | 85 | 550 | 4 |
| 6055K/85 red SH | 78064 6 | 85 | 550 | 6 |
| SH 6055 | 61572 6 | | 60 | 3 |
| SR 6055 Selle Royal | 63151 1 | | 64 | 3 |

BORDO™ LITE 6055 COMBO

NIVEAU DE SÉCURITÉ



CARACTÉRISTIQUES



Support SR 6055



Support SH 6055



VARIANTES



black



blue Symbols



red



red



Movistar



pink Symbols

Antivolis pliables

DONNÉES TECHNIQUES

- Barres articulées de 5mm d'épaisseur avec revêtement extra souple pour protéger contre les dommages causés par la peinture
- Les barres et le boîtier sont fabriqués à partir de matériaux particulièrement légers et d'alliages d'acier
- Barres reliées par des rivets spéciaux
- Les molettes à 2 composants assurent une lisibilité permanente de numéros
- Code configurable individuellement
- Un rapport sécurité-poids parfait
- Avec support (SH ou SR)

TECHNOLOGIE



LOGOS D'AGRÈMENT



| Article | EAN 4003318 |  cm | Poids g | Unité emb. |
|------------------------|----------------|-------------------------------------------------------------------------------------------|---------|------------|
| 6055C/60 black | 62105 5 | 60 | 460 | 6 |
| 6055C/60 black SH | 62110 9 | 60 | 550 | 6 |
| 6055C/60 black SR | 62114 7 | 60 | 550 | 4 |
| 6055C/60 red | 62106 2 | 60 | 460 | 6 |
| 6055C/60 MOVISTAR TEAM | 62107 9 | 60 | 460 | 6 |
| 6055C/60 pink SYMBOLS | 62108 6 | 60 | 460 | 6 |
| 6055C/60 blue SYMBOLS | 62109 3 | 60 | 460 | 6 |
| 6055C/85 black SH | 62111 6 | 85 | 708 | 6 |
| 6055C/85 black SR | 62113 0 | 85 | 708 | 4 |
| 6055C/85 red SH | 62112 3 | 85 | 708 | 6 |
| SH 6055 | 61572 6 | | 60 | 3 |
| SR 6055 Selle Royal | 63151 1 | | 64 | 3 |

CHAÎNES



**GRANIT CITYCHAIN
XPLUS™ 1060**



black

Page 46

**IVY CHAIN
9210**



black

Page 47

**CITYCHAIN™
1010**



black

Page 47

**STEEL-O-CHAIN™
9809K**



black

Page 48

**STEEL-O-CHAIN™
9808K**



black

Page 48

8808C



black

Page 49



russet red

Page 49



jade green

Page 49

**IVEN CHAIN
8210**



black

Page 50

**IVERA CHAIN
7210 COLOR**



racing yellow

Page 51



diving blue

Page 51



crossing grey

Page 51



sparkling orange

Page 51

**IVERA CHAIN
7210**



black

Page 51

**STEEL-O-CHAIN™
8807K**



black

Page 52

**TRESOR
1385**



black

Page 53



aqua

Page 53



coral

Page 53



brown

Page 53

**TRESOR
1385 COLOR**



grey star

Page 54



blue mask

Page 54



grey lightning

Page 54



cherry heart

Page 54

**TRESOR
1385 NEON**



Neon blue

Page 55



black

Page 55



Neon green

Page 55



Neon orange

Page 55



Neon pink

Page 55

**CATENA
6806K**



black

Page 56



aqua

Page 56



coral

Page 56



brown

Page 56

**CATENA
6806K NEON**



Neon pink

Page 56



Neon green

Page 56



Neon blue

Page 56



Neon orange

Page 56

**CATENA
6806K COLOR**



cherry heart

Page 57



blue mask

Page 57



grey lightning

Page 57



grey star

Page 57

**CATENA
6806K REFLECTIVE**



reflective

Page 57

**STEEL-O-CHAIN™
5805K**



black

Page 58



blue

Page 58



red

Page 58



lime

Page 58



pink

Page 58

**STEEL-O-CHAIN™
5805C**



black

Page 58



blue

Page 58



red

Page 58



lime

Page 58



pink

Page 58

**STEEL-O-CHAIN™
4804K**



black

Page 59



blue

Page 59



red

Page 59



lime

Page 59



pink

Page 59

**STEEL-O-CHAIN™
4804C SYMBOLS**



lime SYMBOLS

Page 60



blue SYMBOLS

Page 60



pink SYMBOLS

Page 60



red SYMBOLS

Page 60

**STEEL-O-CHAIN™
4804C**



black

Page 60



blue

Page 60



red

Page 60



lime

Page 60



pink

Page 60

1500 WEB



black

Page 61



lime

Page 61



orange

Page 61



red

Page 61



white

Page 61



coral

Page 61

1200 WEB



black

Page 61



lime

Page 61



orange

Page 61



red

Page 61



white

Page 61



coral

Page 61

GRANIT CITYCHAIN 1060 XPLUS™

NIVEAU DE SÉCURITÉ



CARACTÉRISTIQUES



DONNÉES TECHNIQUES

- Chaîne à maillons hexagonales de 10 mm équipée d'un gainage en tissu, pour protéger la peinture du vélo
- La technologie ABUS Power Cell brevetée offre une protection très élevée contre les coups et les torsions
- "Power Link Technology" offre un verrouillage direct de la chaîne au boîtier "Power Cell" et augmente ainsi son efficacité
- Construction emboîtée du corps pour une protection élevée contre toutes sortes d'attaques brutales
- La chaîne, le boîtier et certains éléments de fermeture sont en acier spécial cémenté
- Le cylindre ABUS XPlus offre une protection très élevée contre les manipulations (par exemple le crochetage)
- Cache-entrée de clé automatique pour protéger de la poussière et de la corrosion

TECHNOLOGIE



LOGOS D'AGRÈMENT



1) Class C 2) 17218 3) seulement valable pour les versions 1060/85 & 1060/110

| Article | EAN 4003318 | ⌀ mm | ●—● cm | Poids g | Unité emb. |
|----------------|----------------|---------|-----------|---------|------------|
| 1060/85 black | 28678 0 | 10 | 85 | 2100 | 2 |
| 1060/110 black | 28623 0 | 10 | 110 | 2650 | 2 |
| 1060/140 black | 28624 7 | 10 | 140 | 3260 | 2 |
| 1060/170 black | 28625 4 | 10 | 170 | 3750 | 2 |

IVY CHAIN 9210

CARACTÉRISTIQUES



NIVEAU DE SÉCURITÉ



TECHNOLOGIE



DONNÉES TECHNIQUES

- Chaîne à maillons hexagonales de 10 mm de diamètre recouverte d'une gaine en mailles durable et hautement flexible, pour protéger la peinture du vélo
- La chaîne, le boîtier et certains éléments de fermeture sont en acier spécial cimenté
- Verrouillage ergonomique du boîtier
- Équipé d'une clé reversible, facile à utiliser

LOGOS D'AGRÈMENT



| Article | EAN 4003318 | mm | cm | Poids g | Unité emb. |
|----------------|----------------|----|-----|---------|------------|
| 9210/85 black | 88691 1 | 10 | 85 | 2440 | 2 |
| 9210/110 black | 88692 8 | 10 | 110 | 3000 | 2 |
| 9210/140 black | 88693 5 | 10 | 140 | 3650 | 1 |
| 9210/170 black | 88694 2 | 10 | 170 | 4400 | 1 |

CITYCHAIN™ 1010

CARACTÉRISTIQUES



Plus



NIVEAU DE SÉCURITÉ



DONNÉES TECHNIQUES

- Chaîne à maillons hexagonales de 9mm de diamètre avec un gainage en tissu pour protéger la peinture du vélo
- La chaîne, le boîtier et certains éléments de fermeture sont en acier spécial cimenté
- Cylindre ABUS Plus pour une protection élevée contre les manipulations, comme le crochetage
- Equipée d'un cache-entrée de clé automatique pour protéger de la poussière et de la corrosion

TECHNOLOGIE



LOGOS D'AGRÈMENT



1) Class B

| Article | EAN 4003318 | mm | cm | Poids g | Unité emb. |
|----------------|----------------|----|-----|---------|------------|
| 1010/85 black | 33559 4 | 9 | 85 | 1850 | 2 |
| 1010/110 black | 12042 8 | 9 | 110 | 2200 | 2 |
| 1010/140 black | 12527 0 | 9 | 140 | 2650 | 2 |
| 1010/170 black | 12528 7 | 9 | 170 | 3200 | 2 |

STEEL-O-CHAIN™ 9809K

CARACTÉRISTIQUES



XPlus™



DONNÉES TECHNIQUES

- chaîne à maillons carrés de 9 mm d'épaisseur
- La chaîne, le boîtier et les pièces de support du mécanisme de verrouillage sont fabriqués en acier spécialement trempé
- Equipée d'un cache-entrée de clé automatique pour protéger de la poussière et de la corrosion
- Cylindre ABUS XPlus pour une protection extrêmement élevée contre le vol, par exemple le crochetage

NIVEAU DE SÉCURITÉ



LOGOS D'AGRÈMENT



1) 35210

TECHNOLOGIE



| Article | EAN 4003318 | mm | cm | Poids g | Unité emb. |
|-----------------|----------------|----|-----|---------|------------|
| 9809K/85 black | 95548 8 | 9 | 85 | 1750 | 2 |
| 9809K/110 black | 95549 5 | 9 | 110 | 2250 | 2 |
| 9809K/140 black | 95550 1 | 9 | 140 | 2800 | 2 |
| 9809K/170 black | 95551 8 | 9 | 170 | 3050 | 2 |

STEEL-O-CHAIN™ 9808K

CARACTÉRISTIQUES



XPlus™



DONNÉES TECHNIQUES

- chaîne à maillons carrés de 8 mm d'épaisseur
- La chaîne, le boîtier et les pièces de support du mécanisme de verrouillage sont fabriqués en acier spécialement trempé
- Equipée d'un cache-entrée de clé automatique pour protéger de la poussière et de la corrosion
- Cylindre ABUS XPlus pour une protection extrêmement élevée contre le vol, par exemple le crochetage

NIVEAU DE SÉCURITÉ



LOGOS D'AGRÈMENT



1) Class B 2) 33324

TECHNOLOGIE



| Article | EAN 4003318 | mm | cm | Poids g | Unité emb. |
|-----------------|----------------|----|-----|---------|------------|
| 9808K/85 black | 95562 4 | 8 | 85 | 1750 | 2 |
| 9808K/110 black | 95564 8 | 8 | 110 | 2250 | 2 |
| 9808K/140 black | 95565 5 | 8 | 140 | 2800 | 2 |
| 9808K/170 black | 95566 2 | 8 | 170 | 3050 | 2 |

8808C

NIVEAU DE SÉCURITÉ



VARIANTES



russet red



jade green

Chaînes

DONNÉES TECHNIQUES

- Chaîne à maillons de 8mm recouverte d'un gainage en tissu pour protéger la peinture du vélo
- La chaîne est fabriquée en acier spécialement trempé
- Les molettes à deux composantes garantissent la lisibilité à long terme des chiffres
- Code configurable individuellement

TECHNOLOGIE



| Article | EAN 4003318 | ⌀ mm | ●-● cm | Poids g | Unité emb. |
|---------------------|----------------|---------|-----------|---------|------------|
| 8808C/85 black | 61490 3 | 8 | 85 | 1990 | 2 |
| 8808C/85 russet red | 61491 0 | 8 | 85 | 1990 | 2 |
| 8808C/85 jade green | 61492 7 | 8 | 85 | 1990 | 2 |
| 8808C/110 black | 61494 1 | 8 | 110 | 2370 | 2 |

IVEN CHAIN 8210

NIVEAU DE SÉCURITÉ



CARACTÉRISTIQUES



DONNÉES TECHNIQUES

- Chaîne à maillons carrés de 8 mm de diamètre recouverte d'un gainage en tissu pour protéger la peinture du vélo
- La chaîne, le boîtier et certains éléments de fermeture sont en acier spécial cémenté

TECHNOLOGIE



LOGOS D'AGRÈMENT



1) 24192

| Article | EAN 4003318 | ⊕ mm | ●—● cm | Poids g | Unité emb. |
|----------------|----------------|---------|-----------|---------|------------|
| 8210/85 black | 55152 9 | 8 | 85 | 1800 | 2 |
| 8210/110 black | 55153 6 | 8 | 110 | 2200 | 2 |
| 8210/140 black | 88288 3 | 8 | 140 | 3185 | 2 |

IVERA CHAIN 7210 COLOR

CARACTÉRISTIQUES



Support IVERA RBU

NIVEAU DE SÉCURITÉ VARIANTES



sparkling orange



diving blue



crossing grey

| Article | EAN 4003318 | mm | cm | Poids g | Unité emb. |
|---------------------------|----------------|----|-----|---------|------------|
| 7210/85 sparkling orange | 87777 3 | 7 | 85 | 1300 | 2 |
| 7210/85 racing yellow | 87778 0 | 7 | 85 | 1300 | 2 |
| 7210/85 diving blue | 87779 7 | 7 | 85 | 1300 | 2 |
| 7210/85 crossing grey | 87780 3 | 7 | 85 | 1300 | 2 |
| 7210/110 sparkling orange | 87783 4 | 7 | 110 | 1500 | 2 |
| 7210/110 racing yellow | 87782 7 | 7 | 110 | 1500 | 2 |
| 7210/110 diving blue | 87784 1 | 7 | 110 | 1500 | 2 |
| 7210/110 crossing grey | 87781 0 | 7 | 110 | 1500 | 2 |
| Support IVERA RBU | 58497 8 | | | 125 | 1 |

DONNÉES TECHNIQUES

- Chaîne à maillons carrés de 7 mm de diamètre, très flexible et durable pour éviter d'endommager la peinture du vélo
- La gaine offre une très grande protection contre l'abrasion et n'absorbe aucun liquide, comme par exemple l'eau ou l'huile
- La chaîne, le boîtier et les éléments du mécanisme de verrouillage sont en acier spécial cémenté

TECHNOLOGIE



IVERA CHAIN 7210

CARACTÉRISTIQUES



Support IVERA RBU

NIVEAU DE SÉCURITÉ



| Article | EAN 4003318 | mm | cm | Poids g | Unité emb. |
|-------------------|----------------|----|-----|---------|------------|
| 7210/85 | 55141 3 | 7 | 85 | 1300 | 2 |
| 7210/110 | 55142 0 | 7 | 110 | 1500 | 2 |
| Support IVERA RBU | 58497 8 | | | 125 | 1 |

DONNÉES TECHNIQUES

- Chaîne à maillons carrés de 7 mm de diamètre recouverte d'un gainage en tissu pour protéger la peinture du vélo
- La chaîne, le boîtier et certains éléments de fermeture sont en acier spécial cémenté

TECHNOLOGIE



STEEL-O-CHAIN™ 8807K

NIVEAU DE SÉCURITÉ



CARACTÉRISTIQUES



DONNÉES TECHNIQUES

- Chaîne à maillons carrés de 7 mm de diamètre recouverte d'un gainage en tissu pour protéger la peinture du vélo
- La chaîne, le boîtier et certains éléments de fermeture sont en acier spécial cémenté

TECHNOLOGIE



| Article | EAN 4003318 | ⌀ mm | ●—● cm | Poids g | Unité emb. |
|-----------------|----------------|---------|-----------|---------|------------|
| 8807K/85 black | 71195 4 | 7 | 85 | 1600 | 2 |
| 8807K/110 black | 82519 4 | 7 | 110 | 1900 | 2 |

TRESOR 1385

NIVEAU DE SÉCURITÉ



VARIANTES



aqua



coral



brown

Chaînes

DONNÉES TECHNIQUES

- Chaîne à maillons carrés de 7 mm de diamètre recouverte d'un gainage en tissu pour protéger la peinture du vélo
- La chaîne est en acier spécial cémenté
- Bonne finition des molettes garantissant une très bonne visibilité des chiffres à long terme
- Molettes spéciales ergonomiques pour protéger des tentatives d'ouverture malintentionnées
- Programmation individuelle du code

TECHNOLOGIE



| Article | EAN 4003318 | ⌀ mm | ●—○ cm | Poids g | Unité emb. |
|----------------|----------------|---------|-----------|---------|------------|
| 1385/85 black | 48566 4 | 7 | 85 | 1050 | 2 |
| 1385/85 aqua | 48567 1 | 7 | 85 | 1050 | 2 |
| 1385/85 coral | 48568 8 | 7 | 85 | 1050 | 2 |
| 1385/85 brown | 48569 5 | 7 | 85 | 1050 | 2 |
| 1385/110 black | 48628 9 | 7 | 110 | 1350 | 2 |

TRESOR 1385 COLOR

NIVEAU DE SÉCURITÉ



VARIANTES



grey star



blue mask



grey lightning

DONNÉES TECHNIQUES

- Chaîne à maillons carrés de 6 mm de diamètre recouverte d'un gainage en tissu pour protéger la peinture du vélo
- La chaîne est en acier spécial cémenté
- Bonne finition des molettes garantissant une très bonne visibilité des chiffres à long terme
- Molettes spéciales ergonomiques pour protéger des tentatives d'ouverture malintentionnées
- Programmation individuelle du code

TECHNOLOGIE



| Article | EAN 4003318 | ⌀ mm | ●—● cm | Poids g | Unité emb. |
|------------------------|----------------|---------|-----------|---------|------------|
| 1385/75 grey star | 88010 0 | 6 | 75 | 750 | 6 |
| 1385/75 blue mask | 88011 7 | 6 | 75 | 750 | 6 |
| 1385/75 grey lightning | 88012 4 | 6 | 75 | 750 | 6 |
| 1385/75 cherry heart | 88013 1 | 6 | 75 | 750 | 6 |

TRESOR 1385 NEON

NIVEAU DE SÉCURITÉ



VARIANTES



black



neon green



neon orange



neon pink

Chaînes

DONNÉES TECHNIQUES

- Chaîne à maillons carrés de 6 mm de diamètre recouverte d'un gainage en tissu pour protéger la peinture du vélo
- La chaîne est en acier spécial cémenté
- Bonne finition des molettes garantissant une très bonne visibilité des chiffres à long terme
- Molettes spéciales ergonomiques pour protéger des tentatives d'ouverture malintentionnées
- Programmation individuelle du code

TECHNOLOGIE



| Article | EAN 4003318 | ⌀ mm | ●—● cm | Poids g | Unité emb. |
|---------------------|----------------|---------|-----------|---------|------------|
| 1385/75 black | 51133 2 | 6 | 75 | 750 | 6 |
| 1385/75 neon green | 71263 0 | 6 | 75 | 750 | 6 |
| 1385/75 neon blue | 71262 3 | 6 | 75 | 750 | 6 |
| 1385/75 neon orange | 71264 7 | 6 | 75 | 750 | 6 |
| 1385/75 neon pink | 71265 4 | 6 | 75 | 750 | 6 |

CATENA 6806K

CARACTÉRISTIQUES



Support QST



NIVEAU DE SÉCURITÉ VARIANTES





aqua



coral



brown

| Article | EAN 4003318 |  mm |  cm | Poids g | Unité emb. |
|---------------------|----------------|-----------------------------------------------------------------------------------------|------------------------------------------------------------------------------------------|---------|------------|
| 6806K/85 black | 90169 0 | 6 | 85 | 920 | 6 |
| 6806K/85 black QST | 95483 2 | 6 | 85 | 1150 | 1 |
| 6806K/85 aqua | 90282 6 | 6 | 85 | 920 | 6 |
| 6806K/85 coral | 90284 0 | 6 | 85 | 920 | 6 |
| 6806K/85 brown | 90283 3 | 6 | 85 | 920 | 6 |
| 6806K/110 black | 82511 8 | 6 | 110 | 1160 | 6 |
| 6806K/110 black QST | 95479 5 | 6 | 110 | 1390 | 1 |
| Support QST | 61493 4 | | | 260 | 1 |

DONNÉES TECHNIQUES

- Chaîne à maillons carrés de 6 mm de diamètre recouverte d'un gainage en tissu pour protéger la peinture du vélo
- La chaîne est en acier spécial cimenté

TECHNOLOGIE



CATENA 6806K NEON

CARACTÉRISTIQUES



Support QST



NIVEAU DE SÉCURITÉ VARIANTES





neon green



neon blue



neon orange

| Article | EAN 4003318 |  mm |  cm | Poids g | Unité emb. |
|----------------------|----------------|-------------------------------------------------------------------------------------------|--------------------------------------------------------------------------------------------|---------|------------|
| 6806K/85 neon green | 90290 1 | 6 | 85 | 920 | 6 |
| 6806K/85 neon blue | 90289 5 | 6 | 85 | 920 | 6 |
| 6806K/85 neon orange | 90291 8 | 6 | 85 | 920 | 6 |
| 6806K/85 neon pink | 90292 5 | 6 | 85 | 920 | 6 |
| Support QST | 61493 4 | | | 260 | 1 |

DONNÉES TECHNIQUES

- Chaîne à maillons carrés de 6 mm de diamètre recouverte d'un gainage en tissu pour protéger la peinture du vélo
- La chaîne est en acier spécial cimenté

TECHNOLOGIE



CATENA 6806 COLOR

CARACTÉRISTIQUES



Support QST



NIVEAU DE SÉCURITÉ VARIANTES





blue mask



grey lightning



grey star

| Article | EAN 4003318 |  mm |  cm | Poids g | Unité emb. |
|-------------------------|----------------|-----------------------------------------------------------------------------------------|------------------------------------------------------------------------------------------|---------|------------|
| 6806K/85 cherry heart | 90288 8 | 6 | 85 | 920 | 6 |
| 6806K/85 blue mask | 90286 4 | 6 | 85 | 920 | 6 |
| 6806K/85 grey lightning | 90287 1 | 6 | 85 | 920 | 6 |
| 6806K/85 grey star | 90285 7 | 6 | 85 | 920 | 6 |
| Support QST | 61493 4 | | | 260 | 1 |

DONNÉES TECHNIQUES

- Chaîne à maillons carrés de 6 mm de diamètre recouverte d'un gainage en tissu pour protéger la peinture du vélo
- La chaîne et le boîtier sont faits en acier spécial cémenté

TECHNOLOGIE



CATENA 6806K REFLECTIVE

CARACTÉRISTIQUES





Support QST



NIVEAU DE SÉCURITÉ



| Article | EAN 4003318 |  mm |  cm | Poids g | Unité emb. |
|----------------------|----------------|-------------------------------------------------------------------------------------------|--------------------------------------------------------------------------------------------|---------|------------|
| 6806K/85 reflective | 69104 1 | 6 | 85 | 920 | 6 |
| 6806K/110 reflective | 69105 8 | 6 | 110 | 1160 | 6 |
| Support QST | 61493 4 | | | 260 | 1 |

DONNÉES TECHNIQUES

- Chaîne à maillons carrés de 6 mm de diamètre recouverte d'un gainage en tissu pour protéger la peinture du vélo
- La chaîne est en acier spécial cémenté

TECHNOLOGIE



STEEL-O-CHAIN™ 5805K

CARACTÉRISTIQUES



DONNÉES TECHNIQUES

- Chaîne à maillons carrés de 5 mm avec une gaine en tissu pour protéger la peinture du vélo
- La chaîne est en acier spécial cémenté

NIVEAU DE SÉCURITÉ VARIANTES



blue



red



lime



pink



Article

EAN
4003318



mm



cm

Poids g

Unité emb.

| Article | EAN 4003318 | mm | cm | Poids g | Unité emb. |
|-----------------|----------------|----|-----|---------|------------|
| 5805K/75 black | 71205 0 | 5 | 75 | 590 | 6 |
| 5805K/75 blue | 72490 9 | 5 | 75 | 590 | 6 |
| 5805K/75 red | 72489 3 | 5 | 75 | 590 | 6 |
| 5805K/75 lime | 72491 6 | 5 | 75 | 590 | 6 |
| 5805K/75 pink | 72492 3 | 5 | 75 | 590 | 6 |
| 5805K/110 black | 72493 0 | 5 | 110 | 780 | 6 |

STEEL-O-CHAIN™ 5805C

NIVEAU DE SÉCURITÉ VARIANTES



blue



red



lime



pink



DONNÉES TECHNIQUES

- Chaîne à maillons carrés de 5 mm avec une gaine en tissu pour protéger la peinture du vélo
- La chaîne est en acier spécial cémenté
- Bonne finition des molettes à deux composantes molettes garantissant une très bonne visibilité des chiffres à long terme
- Programmation individuelle du code

TECHNOLOGIE

Article

EAN
4003318



mm



cm

Poids g

Unité emb.

| Article | EAN 4003318 | mm | cm | Poids g | Unité emb. |
|-----------------|----------------|----|-----|---------|------------|
| 5805C/75 black | 71206 7 | 5 | 75 | 500 | 6 |
| 5805C/75 blue | 72494 7 | 5 | 75 | 500 | 6 |
| 5805C/75 red | 72495 4 | 5 | 75 | 500 | 6 |
| 5805C/75 lime | 72496 1 | 5 | 75 | 500 | 6 |
| 5805C/75 pink | 72497 8 | 5 | 75 | 500 | 6 |
| 5805C/110 black | 72498 5 | 5 | 110 | 720 | 6 |

STEEL-O-CHAIN™ 4804K

NIVEAU DE SÉCURITÉ



CARACTÉRISTIQUES



VARIANTES



blue



red



lime



pink

DONNÉES TECHNIQUES

- Chaîne à maillons carrés de 4 mm avec une gaine en tissu pour protéger la peinture du vélo
- La chaîne est en acier spécial cimenté

TECNOLOGIE



| Article | EAN 4003318 | ⌀ mm | ●—● cm | Poids g | Unité emb. |
|-----------------|----------------|---------|-----------|---------|------------|
| 4804K/75 black | 72483 1 | 4 | 75 | 380 | 6 |
| 4804K/75 blue | 72484 8 | 4 | 75 | 380 | 6 |
| 4804K/75 red | 72485 5 | 4 | 75 | 380 | 6 |
| 4804K/75 lime | 72486 2 | 4 | 75 | 380 | 6 |
| 4804K/75 pink | 72487 9 | 4 | 75 | 380 | 6 |
| 4804K/110 black | 72488 6 | 4 | 110 | 520 | 6 |

STEEL-O-CHAIN™ 4804C SYMBOLS



DONNÉES TECHNIQUES

- Chaîne à maillons carrés de 4 mm de diamètre recouverte d'un gainage en tissu pour protéger la peinture du vélo
- La chaîne est faite en acier spécial cémenté
- Utilisation ludique et facile pour les enfants grâce aux symboles au lieu des chiffres
- Programmation individuelle du code

TECHNOLOGIE



NIVEAU DE SÉCURITÉ VARIANTES



symbols blue



symbols pink



symbols red

Article

EAN
4003318



mm



cm

Poids g

Unité emb.

4804C/75 blue SYMBOLS

86809 2

4

75

360

6

4804C/75 pink SYMBOLS

86810 8

4

75

360

6

4804C/75 red SYMBOLS

87499 4

4

75

360

6

4804C/75 lime SYMBOLS

87498 7

4

75

360

6

STEEL-O-CHAIN™ 4804C



DONNÉES TECHNIQUES

- Chaîne à maillons carrés de 4 mm avec une gaine en tissu pour protéger la peinture du vélo
- La chaîne est en acier spécial cémenté
- Programmation individuelle du code

TECHNOLOGIE



NIVEAU DE SÉCURITÉ VARIANTES



black



blue



red



lime



pink

Article

EAN
4003318



mm



cm

Poids g

Unité emb.

4804C/75 black

71617 1

4

75

360

6

4804C/75 blue

71616 4

4

75

360

6

4804C/75 red

72468 8

4

75

360

6

4804C/75 lime

72480 0

4

75

360

6

4804C/75 pink

72481 7

4

75

360

6

4804C/110 black

72482 4

4

110

480

6

1500 WEB

CARACTÉRISTIQUES



DONNÉES TECHNIQUES

- Chaîne à maillons carrés de 4 mm avec une gaine en tissu pour protéger la peinture du vélo
- La chaîne est en acier spécial cémenté

TECHNOLOGIE



NIVEAU DE SÉCURITÉ VARIANTES



lime



orange



red



white



coral

Article

EAN
4003318

Exécution



mm



cm

Poids g

Unité emb.

| Article | EAN 4003318 | Exécution | mm | cm | Poids g | Unité emb. |
|--------------------|----------------|----------------------|----|-----|---------|------------|
| 1500/60 web black | 56345 4 | | 4 | 60 | 230 | 12 |
| 1500/60 web lime | 56344 7 | | 4 | 60 | 230 | 12 |
| 1500/60 web orange | 56920 3 | | 4 | 60 | 230 | 12 |
| 1500/60 web red | 56343 0 | | 4 | 60 | 230 | 12 |
| 1500/60 web white | 56921 0 | | 4 | 60 | 230 | 12 |
| 1500/60 web coral | 57895 3 | | 4 | 60 | 230 | 12 |
| 1500/60 web color | 57658 4 | 4x lime, orange, red | 4 | 60 | 230 | 12 |
| 1500/110 web black | 56346 1 | | 4 | 110 | 360 | 12 |
| 1500/110 web color | 57659 1 | 4x lime, orange, red | 4 | 110 | 360 | 12 |

1200 WEB

NIVEAU DE SÉCURITÉ VARIANTES



lime



orange



red



white



pink

Article

EAN
4003318

Exécution



mm



cm

Poids g

Unité emb.

| Article | EAN 4003318 | Exécution | mm | cm | Poids g | Unité emb. |
|--------------------|----------------|----------------------|----|-----|---------|------------|
| 1200/60 web black | 56341 6 | | 4 | 60 | 200 | 12 |
| 1200/60 web lime | 56340 9 | | 4 | 60 | 200 | 12 |
| 1200/60 web orange | 56922 7 | | 4 | 60 | 200 | 12 |
| 1200/60 web red | 56339 3 | | 4 | 60 | 200 | 12 |
| 1200/60 web white | 56924 1 | | 4 | 60 | 200 | 12 |
| 1200/60 web coral | 57893 9 | | 4 | 60 | 200 | 12 |
| 1200/60 web color | 57656 0 | 4x lime, orange, red | 4 | 60 | 200 | 12 |
| 1200/110 web black | 56342 3 | | 4 | 110 | 330 | 12 |
| 1200/110 web color | 57657 7 | 4x lime, orange, red | 4 | 110 | 330 | 12 |

DONNÉES TECHNIQUES

- Chaîne à maillons carrés de 4 mm avec une gaine en tissu pour protéger la peinture du vélo
- La chaîne est en acier spécial cémenté

ANTIVOLS GOOSE

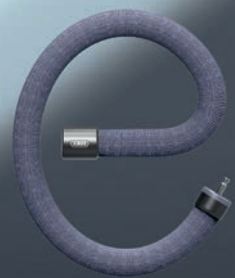
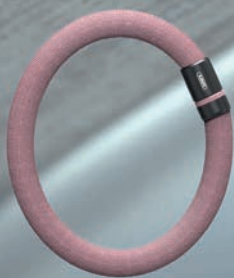

L O C K

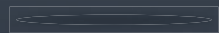
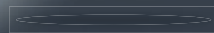
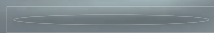

6206K GOOSE LOCK



mint

Page 65



black

Page 65



rosemauve

Page 65



flint

Page 65

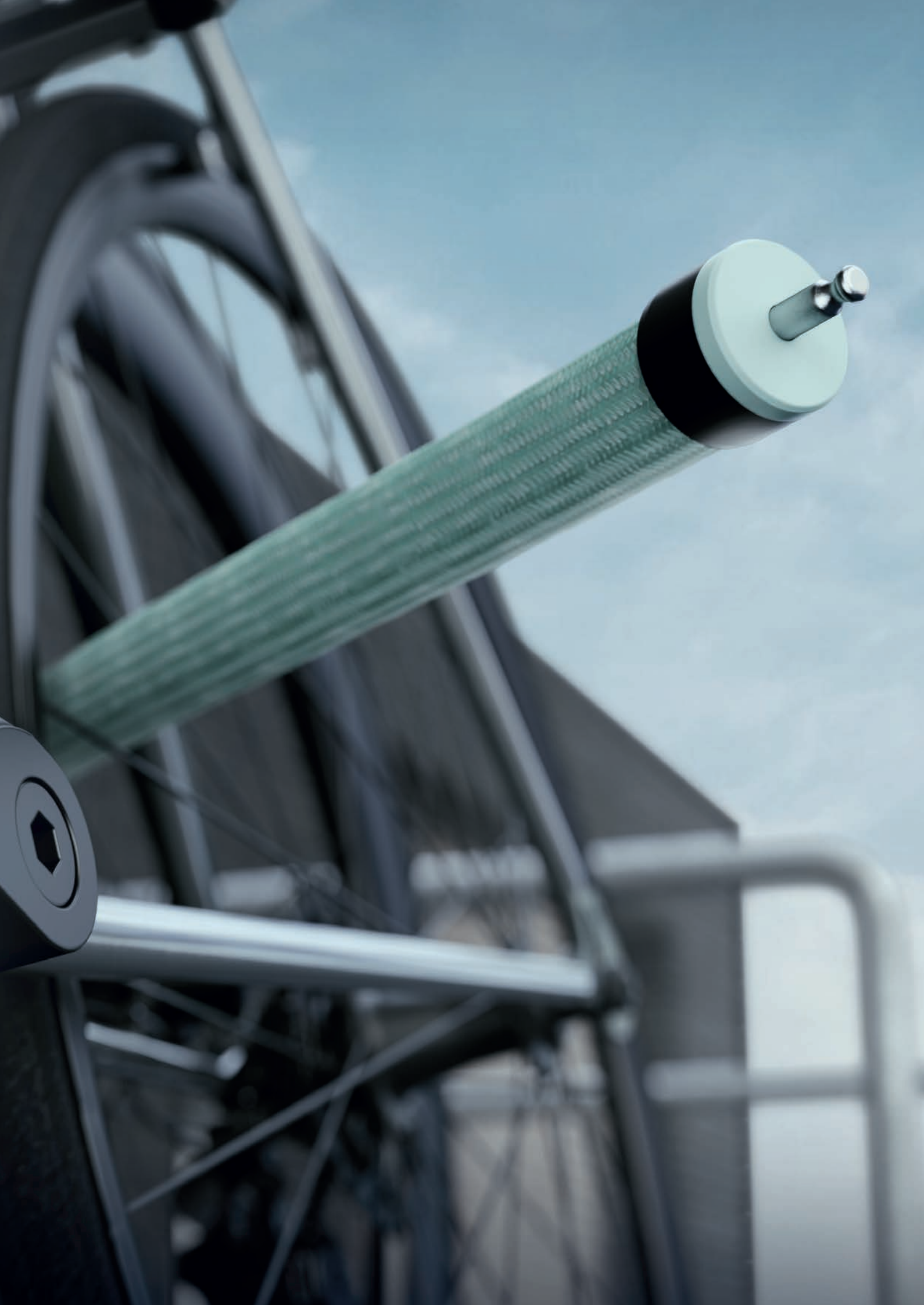

6206K GOOSE LOCK

★
NEW

NIVEAU DE SÉCURITÉ



VARIANTES



black



rosemauve



flint

Antivois Goose

DONNÉES TECHNIQUES

- Chaîne de 6 mm d'épaisseur avec un revêtement en fibres textiles pour protéger la peinture du vélo
- Chaîne à mémoire de forme
- Revêtement souple offrant une très haute protection contre l'abrasion et résistant à l'eau
- La chaîne, le boîtier et les pièces de support du mécanisme de verrouillage sont fabriqués en acier spécialement trempé

TECHNOLOGIE



| Article | EAN 4003318 | ⌀ mm | ●—● cm | Poids g | Unité emb. |
|---------------------|----------------|---------|-----------|---------|------------|
| 6206K/85 black | 95546 4 | 6 | 85 | 920 | 2 |
| 6206K/110 black | 95547 1 | 6 | 110 | 1120 | 2 |
| 6206K/110 rosemauve | 96156 4 | 6 | 110 | 1120 | 2 |
| 6206K/110 mint | 96158 8 | 6 | 110 | 1120 | 2 |
| 6206K/110 flint | 96157 1 | 6 | 110 | 1120 | 2 |

STEEL-0-FLEX



STEEL-O-FLEX™

950



black

Page 68

IVEN STEEL-O-FLEX™

8200



black

Page 68

IVERA STEEL-O-FLEX™

7200



black

Page 69

CENTURO

860



black

Page 69

PHANTOM™

8960



black

Page 70

STEEL-O-FLEX™

RAYDO PRO 1460



black

Page 71

STEEL-O-FLEX™

TRESOR 1360



black

Page 72

MICROFLEX

6615K



black

Page 73

TRESORFLEX

6615C



black

Page 73

STEEL-O-FLEX™ 950

CARACTÉRISTIQUES



Plus



Support UGH 02

NIVEAU DE SÉCURITÉ



DONNÉES TECHNIQUES

- Des rotules en acier de 25 mm de diamètre protègent le câble en acier
- Revêtement synthétique pour protéger la peinture du vélo
- Les rotules, le boîtier et certaines pièces du mécanisme de fermeture sont en acier spécial cimenté
- Le cylindre ABUS Plus offre une protection très efficace contre toute tentative de manipulation, comme le crochetage
- Cache-entrée de clé manuelle pour protéger de la poussière et de la corrosion

LOGOS D'AGRÉMENT



| Article | EAN 4003318 | mm | cm | Poids g | Unité emb. |
|----------------|----------------|----|-----|---------|------------|
| 950/100 | 25715 5 | 25 | 100 | 1540 | 2 |
| Support UGH 02 | 26624 9 | | | 80 | 1 |

IVEN STEEL-O-FLEX™ 8200

CARACTÉRISTIQUES



Support UGH 02

NIVEAU DE SÉCURITÉ



LOGOS D'AGRÉMENT



DONNÉES TECHNIQUES

- Des rotules en acier de 25 mm de diamètre protègent le câble en acier
- Les rotules, le boîtier et certaines pièces du mécanisme de fermeture sont en acier spécial cimenté
- Forme ergonomique du boîtier recouvert de la technologie Softcase offrant une meilleure résistance à l'impact

TECHNOLOGIE



| Article | EAN 4003318 | mm | cm | Poids g | Unité emb. |
|----------------|----------------|----|-----|---------|------------|
| 8200/85 | 55148 2 | 25 | 85 | 1340 | 2 |
| 8200/110 | 55149 9 | 25 | 110 | 1580 | 2 |
| Support UGH 02 | 26624 9 | | | 80 | 1 |

IVERA STEEL- O- FLEX™ 7200

CARACTÉRISTIQUES



Support IVERA RBU

NIVEAU DE SÉCURITÉ



DONNÉES TECHNIQUES



- Des rotules en acier de 22 mm de diamètre protègent le câble en acier
- Recouvert d'une gaine en fibre synthétique (type cotte de mailles) très solide pour une bonne protection du vélo
- Les rotules, le boîtier et certaines pièces du mécanisme de fermeture sont en acier spécial cémenté

TECHNOLOGIE



LOGOS D'AGRÈMENT



| Article | EAN 4003318 |  mm |  cm | Poids g | Unité emb. |
|-------------------|----------------|-----------------------------------------------------------------------------------------|------------------------------------------------------------------------------------------|---------|------------|
| 7200/85 | 55137 6 | 22 | 85 | 700 | 6 |
| 7200/85 + RBU | 55139 0 | 22 | 85 | 840 | 6 |
| 7200/110 | 55138 3 | 22 | 110 | 860 | 6 |
| 7200/110 + RBU | 55140 6 | 22 | 110 | 1000 | 6 |
| Support IVERA RBU | 58497 8 | | | 125 | 1 |

CENTURO 860

CARACTÉRISTIQUES



Support QuickSnap RBU

NIVEAU DE SÉCURITÉ



DONNÉES TECHNIQUES



- Des rotules en acier de 20 mm de diamètre protègent le câble en acier
- Revêtement synthétique pour protéger la peinture du vélo
- Les rotules, le boîtier et certaines pièces du mécanisme de fermeture sont en acier spécial cémenté

TECHNOLOGIE



LOGOS D'AGRÈMENT



| Article | EAN 4003318 |  mm |  cm | Poids g | Unité emb. |
|-----------------------|----------------|-------------------------------------------------------------------------------------------|--------------------------------------------------------------------------------------------|---------|------------|
| 860/85 | 31495 7 | 20 | 85 | 780 | 6 |
| 860/85 QS RBU | 31493 3 | 20 | 85 | 825 | 6 |
| 860/110 | 31496 4 | 20 | 110 | 980 | 6 |
| 860/110 QS RBU | 31494 0 | 20 | 110 | 1025 | 6 |
| 860/85 QS | 31528 2 | 20 | 85 | 840 | 6 |
| Support QuickSnap RBU | 31487 2 | | | 40 | 6 |

PHANTOM™ 8960

NIVEAU DE SÉCURITÉ



CARACTÉRISTIQUES



Support TexFL



Support KF



DONNÉES TECHNIQUES



- Des rotules en acier de 17 mm de diamètre protègent le câble en acier
- Revêtement synthétique pour protéger la peinture du vélo
- Les rotules, le boîtier et certaines pièces du mécanisme de fermeture sont en acier spécial cémenté
- Cylindre ABUS Extra Class avec une clé réversible

TECHNOLOGIE



LOGOS D'AGRÈMENT



| Article | EAN 4003318 |  |  | Poids g | Unité emb. |
|----------------|----------------|-------------------------------------------------------------------------------------|--------------------------------------------------------------------------------------|---------|------------|
| | | mm | cm | | |
| 8960/85 KF | 78595 5 | 17 | 85 | 700 | 6 |
| 8960/85 TexFL | 39680 9 | 17 | 85 | 720 | 6 |
| 8960/110 TexFL | 39683 0 | 17 | 110 | 920 | 6 |
| Support KF | 12433 4 | | | 42 | 6 |
| Support TexFL | 39730 1 | | | 77 | 1 |

STEEL-0-FLEX™ RAYDO PRO 1460

NIVEAU DE SÉCURITÉ



CARACTÉRISTIQUES



Combo Licht



Support TexKF Mini



Support KF



DONNÉES TECHNIQUES



- Des rotules en acier de 20 mm de diamètre protègent le câble en acier
- Revêtement synthétique pour protéger la peinture du vélo
- Les rotules, le boîtier et certaines pièces du mécanisme de fermeture sont en acier spécial cémenté
- Programmation individuelle du code
- La fonction Press'n Shine facilite l'usage dans le noir. Grâce à ses molettes lumineuses qui permettent de faciliter l'ouverture de l'antivol même dans l'obscurité

TECHNOLOGIE



LOGOS D'AGRÈMENT



| Article | EAN 4003318 |  |  | Poids g | Unité emb. |
|--------------------|----------------|-------------------------------------------------------------------------------------|--------------------------------------------------------------------------------------|---------|------------|
| | | mm | cm | | |
| 1460/85 KF | 59216 4 | 20 | 85 | 780 | 6 |
| 1460/85 TexKF | 59217 1 | 20 | 85 | 780 | 6 |
| Support KF | 12433 4 | | | 42 | 6 |
| Support TexKF Mini | 23265 7 | | | 70 | 1 |

STEEL- O- FLEX™ TRESOR 1360

NIVEAU DE SÉCURITÉ



DONNÉES TECHNIQUES



- Des rotules en acier de 20 mm de diamètre protègent le câble en acier
- Revêtement synthétique pour protéger la peinture du vélo
- Bonne finition des molettes garantissant une très bonne visibilité des chiffres à long terme
- Protection spéciale contre toute tentative de manipulation non autorisée du code
- Equipé de touches en relief pour faciliter l'entrée du code dans l'obscurité
- Programmation individuelle du code

TECHNOLOGIE



LOGOS D'AGRÈMENT



| Article | EAN 4003318 |  mm |  cm | Poids g | Unité emb. |
|----------------|----------------|-------------------------------------------------------------------------------------------|--------------------------------------------------------------------------------------------|---------|------------|
| 1360/85 black | 42935 4 | 20 | 85 | 680 | 6 |
| 1360/110 black | 42934 7 | 20 | 110 | 880 | 6 |

MICROFLEX 6615K

CARACTÉRISTIQUES



Support SCMU

Support SCLL

NIVEAU DE SÉCURITÉ





DONNÉES TECHNIQUES

- Des rotules en acier de 15 mm de diamètre protègent le câble en acier
- Revêtement synthétique pour protéger la peinture du vélo

TECHNOLOGIE



| Article | EAN 4003318 |  mm |  cm | Poids g | Unité emb. |
|-------------------------|----------------|-----------------------------------------------------------------------------------------|------------------------------------------------------------------------------------------|---------|------------|
| 6615K/85/15 black | 13410 4 | 15 | 85 | 540 | 6 |
| 6615K/85/15 black SCMU | 13408 1 | 15 | 85 | 580 | 6 |
| 6615K/85/15 black SCLL | 86174 1 | 15 | 85 | 580 | 6 |
| 6615K/120/15 black | 13412 8 | 15 | 120 | 700 | 6 |
| 6615K/120/15 black SCMU | 13409 8 | 15 | 120 | 760 | 6 |
| 6615K/120/15 black SCLL | 86172 7 | 15 | 120 | 760 | 6 |
| Support SCLL 6K | 87984 5 | | | 47 | 12 |
| Support Snap Cage MU 6K | 20079 3 | | | 40 | 12 |

TRESORFLEX 6615C

CARACTÉRISTIQUES



Support SCMU

Support SCLL



DONNÉES TECHNIQUES



- Des rotules en acier de 15 mm de diamètre protègent le câble en acier
- Revêtement synthétique pour protéger la peinture du vélo
- Bonne finition des molettes garantissant une très bonne visibilité des chiffres à long terme
- Protection spéciale contre toute tentative de manipulation non autorisée du code
- Equipé de touches réfléchissantes pour faciliter l'entrée du code dans l'obscurité
- Programmation individuelle du code

TECHNOLOGIE



NIVEAU DE SÉCURITÉ



| Article | EAN 4003318 |  mm |  cm | Poids g | Unité emb. |
|-------------------------|----------------|-------------------------------------------------------------------------------------------|--------------------------------------------------------------------------------------------|---------|------------|
| 6615C/85/15 black | 13659 7 | 15 | 85 | 560 | 6 |
| 6615C/85/15 black SCMU | 13657 3 | 15 | 85 | 705 | 6 |
| 6615C/85/15 black SCLL | 86173 4 | 15 | 85 | 705 | 6 |
| 6615C/120/15 black | 13780 8 | 15 | 120 | 720 | 6 |
| 6615C/120/15 black SCMU | 13658 0 | 15 | 120 | 780 | 6 |
| 6615C/120/15 black SCLL | 86171 0 | 15 | 120 | 780 | 6 |
| Support SCLL 6C | 87983 8 | | | 47 | 12 |
| Support Snap Cage MU 6C | 20113 4 | | | 40 | 12 |

ANTIVOLS CÂBLE EN SPIRALE

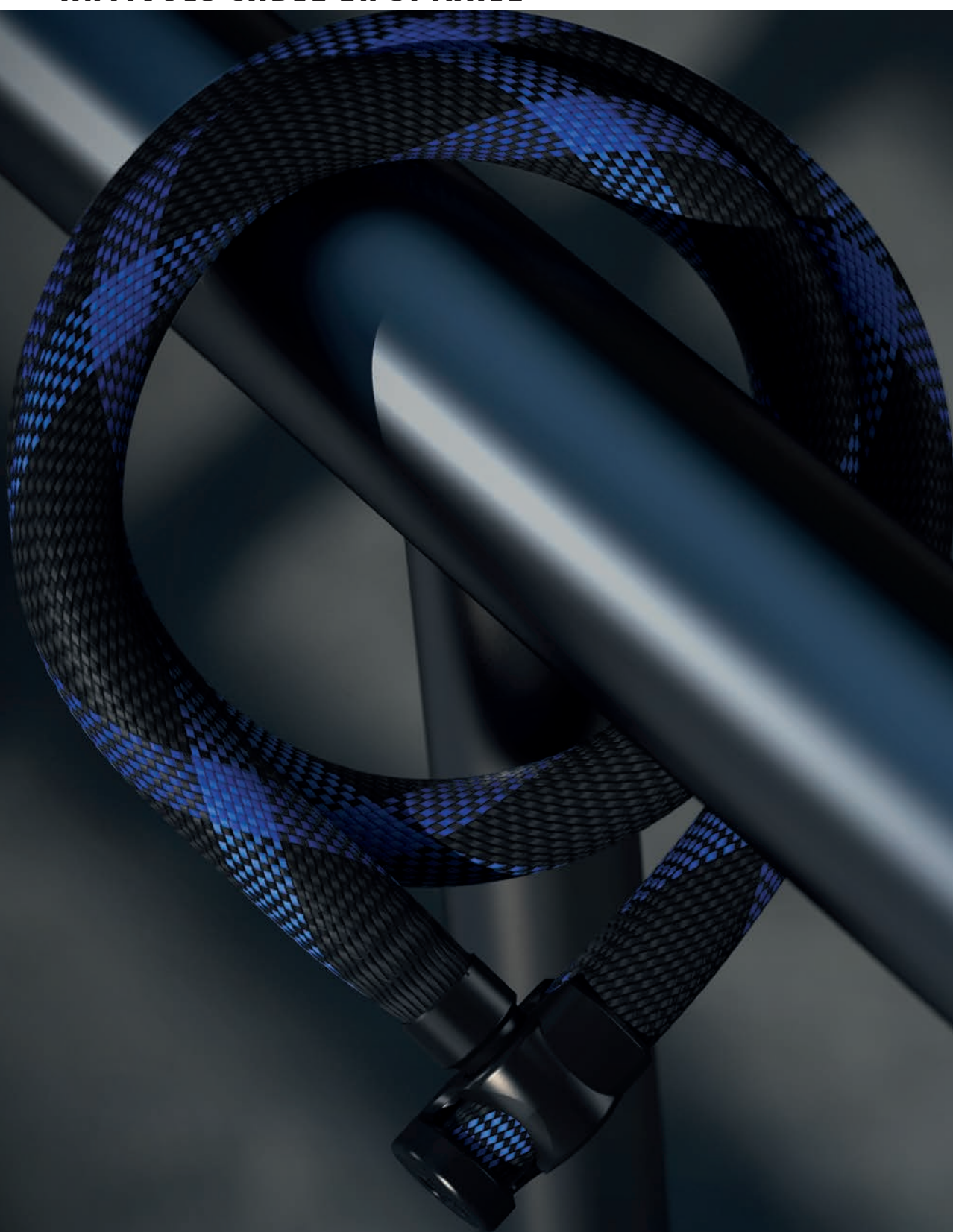

**PHANTOM™
8950**



black

Page 78

**RAYDO PRO
1450**



black

Page 79

**BOOSTER
6512K**



black

Page 80

**TRESOR
6512C**



black

Page 80

**PRIMO
5510K**



black

Page 81

**NUMERO
5510C**



black

Page 81

**STAR
4508K**



black

Page 82



blue

Page 82



red

Page 82



green

Page 82

**STAR
4508C**



black

Page 82



blue

Page 82



red

Page 82



green

Page 82

3506K



black

Page 83



blue

Page 83



orange

Page 83



red

Page 83



green

Page 83



pink

Page 83



silver

Page 83



3506C

black

Page 83



blue

Page 83



orange

Page 83



red

Page 83



green

Page 83



pink

Page 83



silver

Page 83



IVERA CABLE

7220

black

Page 84



RACER

6412K

black

Page 86



TRESOR

6412C

black

Page 86



PRIMO

5410K

black

Page 87



NUMERINO

5410C

black

Page 87



4408K

black

Page 88



blue

Page 88



red

Page 88



green

Page 88



4408C

black

Page 88



blue

Page 88



red

Page 88



green

Page 88

3406K



black

Page 89



blue

Page 89



orange

Page 89



red

Page 89



green

Page 89



pink

Page 89



silver

Page 89

3406C



black

Page 89



blue

Page 89



orange

Page 89



red

Page 89



green

Page 89



pink

Page 89



silver

Page 89

PHANTOM™ 8950

NIVEAU DE SÉCURITÉ



CARACTÉRISTIQUES



Support KF



Support TexKF Mini



Support TexFL





DONNÉES TECHNIQUES

- Câble à spirale de 12 ou de 15 mm de diamètre, très robuste, de bonne qualité et très flexible
- Revêtement synthétique, de couleur noir mat pour protéger la peinture du vélo
- Cylindre ABUS Extra-Classe équipé d'une clé réversible encodée

TECHNOLOGIE



| Article | EAN 4003318 |  mm |  cm | Poids g | Unité emb. |
|----------------|----------------|-------------------------------------------------------------------------------------------|---------------------------------------------------------------------------------------------|------------|---------------|
| 8950/180 KF | 39685 4 | 12 | 180 | 645 | 6 |
| 8950/180 TexKF | 39684 7 | 12 | 180 | 655 | 6 |
| 8950/180 TexFL | 39802 5 | | 180 | 665 | 6 |

RAYDO PRO 1450

NIVEAU DE SÉCURITÉ



CARACTÉRISTIQUES



Support TexKF Mini



DONNÉES TECHNIQUES

- Câble à spirale de 12 mm de diamètre, de bonne qualité et très flexible
- Revêtement synthétique, pour protéger la peinture du vélo
- Programmation individuelle du code
- La fonction Press'n Shine facilite l'usage dans le noir. Grâce à ses molettes lumineuses qui permet de faciliter l'ouverture de l'antivol même dans l'obscurité

TECHNOLOGIE



Antivols câble
en spirale

| Article | EAN 4003318 | mm | cm | Poids g | Unité emb. |
|----------------------|----------------|----|-----|------------|---------------|
| 1450/185 black TexKF | 59214 0 | 12 | 185 | 718 | 6 |

BOOSTER 6512K

CARACTÉRISTIQUES



Support SCMU



DONNÉES TECHNIQUES



- Câble à spirale de 12 mm de diamètre, très robuste, de bonne qualité et très flexible
- Revêtement synthétique, pour protéger la peinture du vélo

TECHNOLOGIE



NIVEAU DE SÉCURITÉ



| Article | EAN 4003318 |  mm |  cm | Poids g | Unité emb. |
|----------------------|----------------|-----------------------------------------------------------------------------------------|-------------------------------------------------------------------------------------------|------------|---------------|
| 6512K/180 black | 13400 5 | 12 | 180 | 531 | 6 |
| 6512K/180 black SCMU | 13399 2 | 12 | 180 | 573 | 6 |

TRESOR 6512C

CARACTÉRISTIQUES



Support SCMU



DONNÉES TECHNIQUES



- Câble en acier de 12 mm d'épaisseur
- Revêtement plastique pour éviter d'endommager la peinture de la bicyclette
- Bonne finition des molettes garantissant une très bonne visibilité des chiffres à long terme
- Programmation individuelle du code

TECHNOLOGIE



NIVEAU DE SÉCURITÉ



| Article | EAN 4003318 |  mm |  cm | Poids g | Unité emb. |
|----------------------|----------------|-------------------------------------------------------------------------------------------|---------------------------------------------------------------------------------------------|------------|---------------|
| 6512C/180 black | 13414 2 | 12 | 180 | 600 | 6 |
| 6512C/180 black SCMU | 13415 9 | 12 | 180 | 549 | 6 |

PRIMO 5510K

CARACTÉRISTIQUES



DONNÉES TECHNIQUES

- Câble à spirale de 10 mm de diamètre, de bonne qualité et très flexible
- Revêtement synthétique, pour protéger la peinture du vélo, des incidents

TECHNOLOGIE



NIVEAU DE SÉCURITÉ



| Article | EAN 4003318 | mm | cm | Poids g | Unité emb. |
|----------------------|----------------|----|-----|------------|---------------|
| 5510K/180 black | 14260 4 | 10 | 180 | 460 | 6 |
| 5510K/180 black SCMU | 14245 1 | 10 | 180 | 508 | 6 |

NUMERO 5510C

CARACTÉRISTIQUES



DONNÉES TECHNIQUES

- Câble à spirale de 10 mm de diamètre, de bonne qualité et très flexible
- Revêtement synthétique, pour protéger la peinture du vélo
- La fonction Dark-touch facilite l'usage dans le noir, grâce à la molette en relief
- Bonne finition des molettes garantissant une très bonne visibilité des chiffres à long terme
- Programmation individuelle du code

TECHNOLOGIE



NIVEAU DE SÉCURITÉ



| Article | EAN 4003318 | mm | cm | Poids g | Unité emb. |
|----------------------|----------------|----|-----|------------|---------------|
| 5510C/180 black | 16524 5 | 10 | 180 | 459 | 6 |
| 5510C/180 black SCMU | 16523 8 | 10 | 180 | 508 | 6 |

Antivois câble en spirale

STAR 4508K

CARACTÉRISTIQUES



DONNÉES TECHNIQUES

- Câble à spirale de 8 mm de diamètre, de bonne qualité et très flexible
- Revêtement synthétique, pour protéger la peinture du vélo

TECHNOLOGIE



NIVEAU DE SÉCURITÉ VARIANTES



blue



red



green

Article

EAN
4003318



mm



cm

Poids
g

Unité
emb.

4508K/150 black

20016 8

8

150

280

12

4508K/150 blue

40775 8

8

150

280

12

4508K/150 red

40776 5

8

150

280

12

4508K/150 green

40777 2

8

150

280

12

STAR 4508C

NIVEAU DE SÉCURITÉ VARIANTES



blue



red



green

Article

EAN
4003318



mm



cm

Poids
g

Unité
emb.

4508C/150 black

20019 9

8

150

260

12

4508C/150 blue

40778 9

8

150

260

12

4508C/150 red

40779 6

8

150

260

12

4508C/150 green

40780 2

8

150

260

12

DONNÉES TECHNIQUES

- Câble en acier de 8 mm de diamètre, de bonne qualité et très flexible
- Revêtement synthétique, pour protéger la peinture du vélo
- La fonction Dark-touch facilite l'usage dans le noir, grâce à la molette en relief
- Programmation individuelle du code
- Bonne finition des molettes garantissant une très bonne visibilité des chiffres à long terme

TECHNOLOGIE



3506K

CARACTÉRISTIQUES



DONNÉES TECHNIQUES

- Câble spiralé de 6 mm d'épaisseur et super flexible
- Revêtement plastique pour éviter d'endommager la peinture du vélo

NIVEAU DE SÉCURITÉ VARIANTES



blue



orange



red



green



pink



silver

Article

EAN
4003318

Version



mm



cm

Poids
g

Unité
emb.

3506K/120 black

40769 7

6

120

206

12

3506K/120 color

40770 3

toutes les couleurs sauf noir

6

120

206

12

3506K/180 black

40771 0

6

180

206

12

3506C



DONNÉES TECHNIQUES

- Câble spiralé de 6 mm d'épaisseur et super flexible
- Revêtement plastique pour éviter d'endommager la peinture du vélo

NIVEAU DE SÉCURITÉ VARIANTES



blue



orange



red



green



pink



silver

Article

EAN
4003318

Version



mm



cm

Poids
g

Unité
emb.

3506C/120 black

40772 7

6

120

174

12

3506C/120 color

40773 4

toutes les couleurs sauf noir

6

120

174

12

IVERA CABLE 7220

NIVEAU DE SÉCURITÉ



CARACTÉRISTIQUES



Support IVERA RBU



DONNÉES TECHNIQUES



- Câble en acier de 20 mm de diamètre de haute qualité
- Recouvert d'une gaine en mailles synthétiques très solide pour une bonne protection de la peinture du vélo
- Le boîtier et certains éléments de fermeture sont en acier cémenté

TECHNOLOGIE



LOGOS D'AGRÈMENT



| Article | EAN 4003318 |  mm |  cm | Poids g | Unité emb. |
|-------------------|----------------|-------------------------------------------------------------------------------------------|---------------------------------------------------------------------------------------------|------------|---------------|
| 7220/85 black | 55145 1 | 20 | 85 | 660 | 6 |
| Support IVERA RBU | 58497 8 | | | 125 | 1 |



RACER 6412K

CARACTÉRISTIQUES



DONNÉES TECHNIQUES



- Câble en acier de 12 mm d'épaisseur
- Revêtement plastique pour éviter d'endommager la peinture du vélo

TECHNOLOGIE



NIVEAU DE SÉCURITÉ VARIANTES



| Article | EAN 4003318 |  mm |  cm | Poids g | Unité emb. |
|---------------------|----------------|-----------------------------------------------------------------------------------------|-------------------------------------------------------------------------------------------|------------|---------------|
| 6412K/85 black | 40804 5 | 12 | 85 | 386 | 6 |
| 6412K/85 black SCMU | 40805 2 | 12 | 85 | 387 | 6 |
| 6412K/120 black | 63491 8 | 12 | 120 | 492 | 6 |

TRESOR 6412C

CARACTÉRISTIQUES



DONNÉES TECHNIQUES



- Câble en acier de 12 mm d'épaisseur
- Revêtement plastique pour éviter d'endommager la peinture du vélo
- Bonne finition des molettes garantissant une très bonne visibilité des chiffres à long terme
- Code configurable individuellement

TECHNOLOGIE



NIVEAU DE SÉCURITÉ VARIANTES



| Article | EAN 4003318 |  mm |  cm | Poids g | Unité emb. |
|---------------------|----------------|-------------------------------------------------------------------------------------------|---------------------------------------------------------------------------------------------|------------|---------------|
| 6412C/85 black | 40807 6 | 12 | 85 | 396 | 6 |
| 6412C/85 black SCMU | 40808 3 | 12 | 85 | 441 | 6 |
| 6412C/120 black | 63489 5 | 12 | 120 | 503 | 6 |

PRIMO 5410K

CARACTÉRISTIQUES



Support SCMU



DONNÉES TECHNIQUES



- Câble en acier de 10 mm d'épaisseur
- Revêtement plastique pour éviter d'endommager la peinture du vélo

TECHNOLOGIE



NIVEAU DE SÉCURITÉ



| Article | EAN 4003318 |  mm |  cm | Poids g | Unité emb. |
|---------------------|----------------|-----------------------------------------------------------------------------------------|-------------------------------------------------------------------------------------------|------------|---------------|
| 5410K/85 black | 40798 7 | 10 | 85 | 278 | 6 |
| 5410K/85 black SCMU | 40799 4 | 10 | 85 | 330 | 6 |

NUMERINO 5410C

NIVEAU DE SÉCURITÉ



| Article | EAN 4003318 |  mm |  cm | Poids g | Unité emb. |
|----------------|----------------|-------------------------------------------------------------------------------------------|---------------------------------------------------------------------------------------------|------------|---------------|
| 5410C/85 black | 40801 4 | 10 | 85 | 276 | 6 |



DONNÉES TECHNIQUES

- Câble en acier de 10 mm d'épaisseur
- Revêtement plastique pour éviter d'endommager la peinture du vélo
- Bonne finition des molettes garantissant une très bonne visibilité des chiffres à long terme
- Code configurable individuellement

TECHNOLOGIE



Antivol câble en spirale

4408K

CARACTÉRISTIQUES



DONNÉES TECHNIQUES

- Câble en acier de 8 mm d'épaisseur
- Revêtement plastique pour éviter d'endommager la peinture du vélo

NIVEAU DE SÉCURITÉ VARIANTES





blue



red



green

| Article | EAN 4003318 |  mm |  cm | Poids g | Unité emb. |
|----------------|----------------|-----------------------------------------------------------------------------------------|-------------------------------------------------------------------------------------------|------------|---------------|
| 4408K/65 black | 40790 1 | 8 | 65 | 271 | 12 |
| 4408K/65 blue | 40791 8 | 8 | 65 | 271 | 12 |
| 4408K/65 red | 40792 5 | 8 | 65 | 271 | 12 |
| 4408K/65 green | 40793 2 | 8 | 65 | 271 | 12 |

4408C

DONNÉES TECHNIQUES

- Câble en acier de 8 mm d'épaisseur
- Revêtement plastique pour éviter d'endommager la peinture du vélo

TECHNOLOGIE



NIVEAU DE SÉCURITÉ VARIANTES





blue



red



green

| Article | EAN 4003318 |  mm |  cm | Poids g | Unité emb. |
|----------------|----------------|-------------------------------------------------------------------------------------------|---------------------------------------------------------------------------------------------|------------|---------------|
| 4408C/65 black | 40794 9 | 8 | 65 | 271 | 12 |
| 4408C/65 blue | 40795 6 | 8 | 65 | 271 | 12 |
| 4408C/65 red | 40796 3 | 8 | 65 | 271 | 12 |
| 4408C/65 green | 40797 0 | 8 | 65 | 271 | 12 |

3406K

CARACTÉRISTIQUES



DONNÉES TECHNIQUES

- Câble en acier de 6 mm d'épaisseur
- Revêtement plastique pour éviter d'endommager la peinture du vélo

NIVEAU DE SÉCURITÉ VARIANTES



blue



orange



red



green



pink



silver

Article

EAN
4003318

Version



mm



cm

Poids
g

Unité
emb.

3406K/55 black

40782 6

6

55

139

12

3406K/55 color

40785 7

toutes les couleurs sauf noir

6

55

139

12

3406C

DONNÉES TECHNIQUES

- Câble en acier de 6 mm d'épaisseur
- Revêtement plastique pour éviter d'endommager la peinture du vélo



NIVEAU DE SÉCURITÉ VARIANTES



blue



orange



red



green



pink



silver

Article

EAN
4003318

Version



mm



cm

Poids
g

Unité
emb.

3406C/55 black

40787 1

6

55

114

12

3406C/55 color

40789 5

toutes les couleurs sauf noir

6

55

114

12

ANTIVOLS DE CADRE ET SERRURES DE BATTERIE



**GRANIT XPLUS™
6950**



black

Page 94

**PRO AMPARO
4750X / XL**



black

Page 96

**PRO AMPARO
4750S / SL**



black

Page 97

4650X / XL



black

Page 98

4650S / SL



black

Page 98

**PRO TECTIC™
4960**



black

Page 99

**TECTIC™
496**



black

Page 99

**ACH 2.0
ADAPTOR CHAIN**



black

Page 100

**ADAPTOR
CABLE**



black

Page 100

**IVYTEX
ADAPTOR CHAIN**



black

Page 101



crossing grey

Page 101

ANTIVOL DE CADRE

Nous aimerions vous aider à trouver encore plus rapidement à l'avenir le bon antivol de cadre pour le vélo de votre client. Le schéma ci-dessous est destiné à vous aider dans ce processus.

Vous pouvez également demander à votre commercial ABUS un outil vous permettant de prendre les mesures (numéro d'article : 90342). Le gabarit est conçu pour que vous puissiez le placer au bon endroit sur le pneu et lire directement quel est le bon antivol.

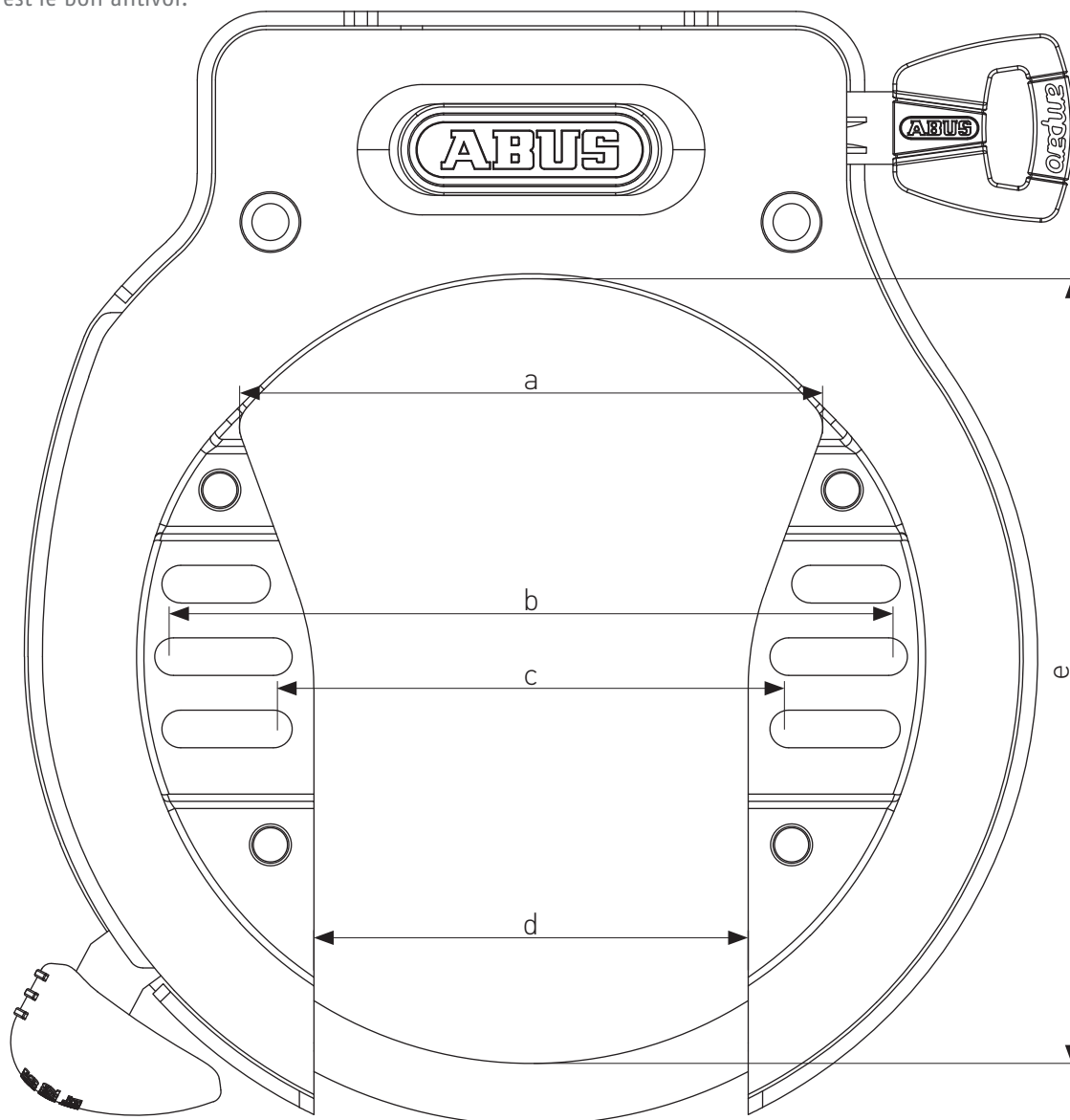

a Largeur maximale du garde-boue

b Espacement maximal des trous pour les points de fixation arrière

c Espacement minimal des trous pour les points de fixation arrière

d Largeur maximale du pneu

e Hauteurs maximales de dégagement (haut du garde-boue par rapport à la jante)

Vous trouverez un aperçu de toutes les dimensions à la page suivante. En outre, vous trouverez également toutes les dimensions pertinentes sur chaque page produit dans les tableaux.

| Article | EAN | a | b | c | d | e | Poids | Unité emb. | PRIX / PCE. € |
|---------|---------|----|----|----|----|----|-------|------------|---------------|
| | 4003318 | mm | mm | mm | mm | mm | g | | |

TOUTES LES TAILLES D'ANTIVOL DE CADRE EN APERÇU

6950M AM

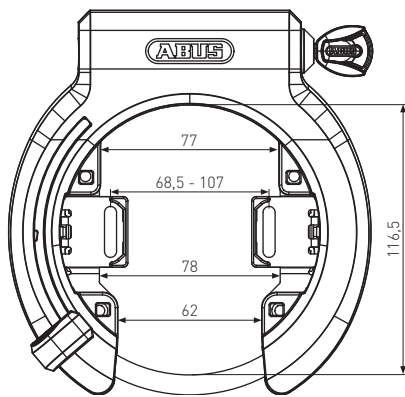

4750X / 4750XL

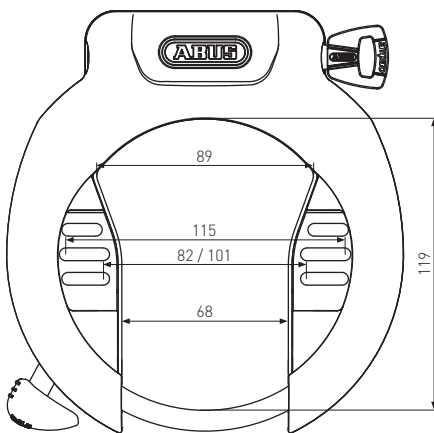

4750S / 4750SL

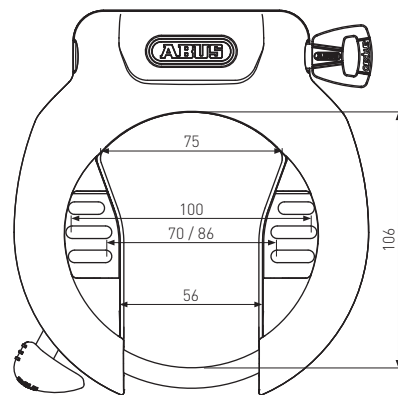

4650X / 4650XL

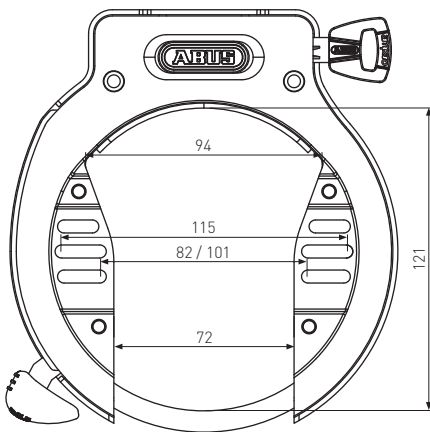

4650S / 4650SL

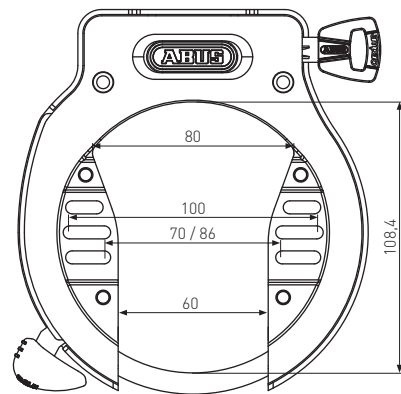

4960

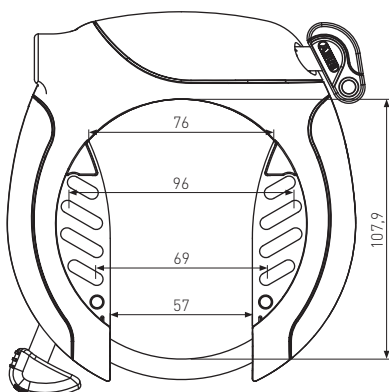

496

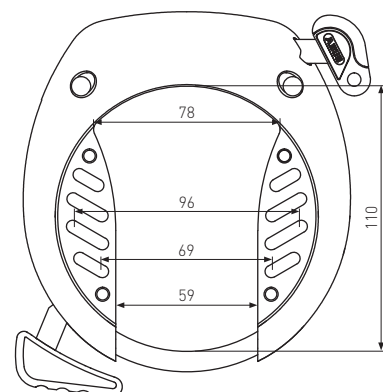

Antivolos de
cadre et serrures
de batterie

Toutes les dimensions sont en mm.

GRANIT XPLUS™ 6950

NIVEAU DE SÉCURITÉ



CARACTÉRISTIQUES



Plaque de fixation



FMU 6950



Adaptateur de plaque
6950



DONNÉES TECHNIQUES

- Anse de verrouillage de 8,5 mm d'épaisseur
- L'anse, le boîtier et les éléments porteurs du mécanisme de verrouillage sont fabriqués en acier spécialement cémenté
- Système de verrouillage pour une connexion facile des accessoires dans la housse d'antivol
- Cylindre ABUS XPlus pour une protection extrêmement élevée contre les manipulations, par exemple le crochetage
- Avec la version R, la clé reste dans le cylindre lorsque l'antivol est ouvert, avec la version NR, elle peut être retirée
- L'espacement des trous pour le montage est réglable de manière universelle

TECHNOLOGIE



LOGOS D'AGRÈMENT



1) 38581 2) seulement valable pour les versions "R"

| Article | EAN 4003318 | a mm | b mm | c mm | d mm | e mm | Poids g | Unité emb. |
|----------------------------------------------|----------------|---------|----------|---------|---------|---------|---------|------------|
| 6950M AM R BK XPlus™ | 61914 4 | 77 | 68,5-107 | 78 | 62 | 116,5 | 770 | 1 |
| 6950M AM R BK XPlus™ OE | 61928 1 | 77 | 68,5-107 | 78 | 62 | 116,5 | 770 | 10 |
| 6950M AM NR BK XPlus™ | 61915 1 | 77 | 68,5-107 | 78 | 62 | 116,5 | 770 | 1 |
| 6950M AM NR BK XPlus™ OE | 61916 8 | 77 | 68,5-107 | 78 | 62 | 116,5 | 770 | 10 |
| 6950M AM NR BK XPlus™ + 6KS/85 + ST 5950 | 95912 7 | 77 | 68,5-107 | 78 | 62 | 116,5 | 1560 | 1 |
| 6950M AM NR BK XPlus™ + 6KS/100 + ST 5950 | 95913 4 | 77 | 68,5-107 | 78 | 62 | 116,5 | 1750 | 1 |
| 6950M AM NR BK XPlus™ + 6KS/130 + ST 5950 | 61924 3 | 77 | 68,5-107 | 78 | 62 | 116,5 | 1920 | 1 |
| FMU 9650 | 96201 1 | | | | | | | 1 |
| Adapter plate 6950 | 99186 8 | | | | | | 40 | 10 |



Security Tech Germany

6950M AM GRANIT XPLUS™

L'ANTIVOL DE CADRE UNIVERSEL POUR TOUS LES VÉLOS !

Grâce au support de vis amovible, un seul antivol est nécessaire pour tous les types de cadre de vélos et de pneus.

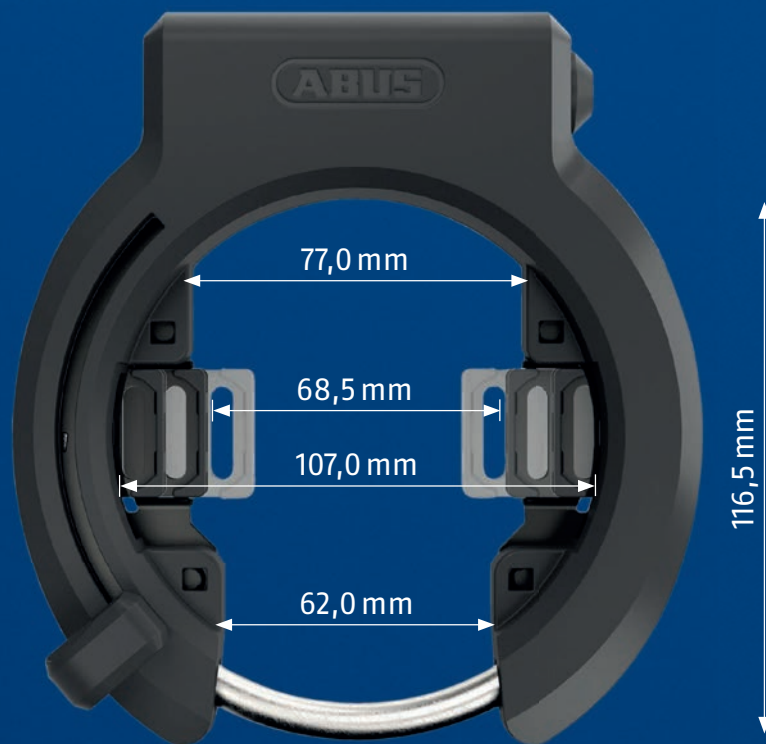

Made in Germany

PRO AMPARO 4750 X / XL

NIVEAU DE SÉCURITÉ



CARACTÉRISTIQUES



SH



Bandes de serrage LH



VARIANTES



4750XL

DONNÉES TECHNIQUES

- Anse en acier de 8,5 mm de diamètre
- L'anse, le boîtier et certains éléments de fermeture sont en acier spécial cémenté
- Très grande ouverture pour des pneus extra larges
- Équipé d'un système de fermeture pour attacher facilement les accessoires au corps de l'antivol
- Avec la version R, la clé reste dans le cylindre lorsque l'antivol est ouvert, avec la version NR, elle peut être retirée

TECNOLOGIE



LOGOS D'AGRÈMENT



1) 35482 2) seulement valable pour les versions "R"

| Article | EAN 4003318 | a mm | b mm | c mm | d mm | e mm | Poids g | Unité emb. |
|----------------------------|----------------|---------|---------|---------|---------|---------|---------|------------|
| 4750X NR black PRO AMPARO | 69349 6 | 89 | 115 | 82 | 68 | 119 | 860 | 12 |
| 4750X NR black OE | 86734 7 | 89 | 115 | 82 | 68 | 119 | 860 | 12 |
| 4750X R black PRO AMPARO | 69352 6 | 89 | 115 | 82 | 68 | 119 | 860 | 12 |
| 4750X R black OE | 86735 4 | 89 | 115 | 82 | 68 | 119 | 860 | 12 |
| 4750XL NR black PRO AMPARO | 69353 3 | 89 | 115 | 101 | 68 | 119 | 800 | 12 |
| 4750XL NR black OE | 86736 1 | 89 | 115 | 101 | 68 | 119 | 800 | 12 |
| 4750XL R black PRO AMPARO | 69354 0 | 89 | 115 | 101 | 68 | 119 | 800 | 12 |
| 4750XL R black OE | 86737 8 | 89 | 115 | 101 | 68 | 119 | 800 | 12 |
| SH485/495 | 37552 1 | | | | | | 56 | 6 |
| Bandes de serrage LH | 56240 2 | | | | | | 48 | 1 |

PRO AMPARO 4750 S / SL

NIVEAU DE SÉCURITÉ



CARACTÉRISTIQUES



SH



Bandes de serrage LH



VARIANTES



4750SL

DONNÉES TECHNIQUES

- Anse de verrouillage de 8,5 mm d'épaisseur
- L'anse, le boîtier et les pièces de support de l'élément de fermeture sont fabriqués en acier spécialement trempé
- Système de verrouillage pour une connexion facile des accessoires dans la housse d'antivol
- Avec la version R, la clé reste dans le cylindre lorsque l'antivol est ouvert, avec la version NR, elle peut être retirée

TECHNOLOGIE



LOGOS D'AGRÈMENT



1) 34358 2) seulement valable pour les versions "R"

| Article | EAN 4003318 | a mm | b mm | c mm | d mm | e mm | Poids g | Unité emb. |
|----------------------------|----------------|---------|---------|---------|---------|---------|---------|------------|
| 4750S NR black PRO AMPARO | 89676 7 | 75 | 100 | 70 | 56 | 106 | 652 | 1 |
| 4750S NR black OE | 82611 5 | 75 | 100 | 70 | 56 | 106 | 700 | 16 |
| 4750S R black PRO AMPARO | 89677 4 | 75 | 100 | 70 | 56 | 106 | 700 | 12 |
| 4750S R black OE | 82612 2 | 75 | 100 | 70 | 56 | 106 | 760 | 1 |
| 4750SL NR black PRO AMPARO | 89678 1 | 75 | 100 | 86 | 56 | 106 | 740 | 1 |
| 4750SL NR black OE | 83573 5 | 75 | 100 | 86 | 56 | 106 | 740 | 16 |
| 4750SL R black PRO AMPARO | 89679 8 | 75 | 100 | 86 | 56 | 106 | 740 | 12 |
| 4750SL R black OE | 83574 2 | 75 | 100 | 86 | 56 | 106 | 740 | 16 |
| SH485/495 | 37552 1 | | | | | | 56 | 6 |
| Bandes de serrage LH | 56240 2 | | | | | | 48 | 1 |

Antivols de
cadre et serrures
de batterie

4650 X / XL

CARACTÉRISTIQUES



SH

Bandes de serrage LH



NIVEAU DE SÉCURITÉ VARIANTES



4650XL

| Article | EAN 4003318 | a mm | b mm | c mm | d mm | e mm | Poids g | Unité emb. |
|----------------------|----------------|---------|---------|---------|---------|---------|---------|------------|
| 4650X NR black OE | 86730 9 | 94 | 115 | 82 | 72 | 121 | 720 | 14 |
| 4650X R black OE | 86731 6 | 94 | 115 | 82 | 72 | 121 | 720 | 14 |
| 4650XL R black OE | 86733 0 | 94 | 115 | 101 | 72 | 121 | 720 | 1 |
| 4650XL NR black OE | 86732 3 | 94 | 115 | 101 | 72 | 121 | 720 | 14 |
| SH485/495 | 37552 1 | | | | | | 56 | 6 |
| Bandes de serrage LH | 56240 2 | | | | | | 48 | 1 |

DONNÉES TECHNIQUES

- Anse en acier de 8,5 mm de diamètre
- L'anse, le boîtier et certains éléments de fermeture sont en acier spécial cémenté
- Très grande ouverture pour des pneus extra larges
- Équipé d'un système de fermeture pour attacher facilement les accessoires au corps de l'antivol
- Avec la version R, la clé reste dans le cylindre lorsque l'antivol est ouvert, avec la version NR, elle peut être retirée

TECHNOLOGIE



LOGOS D'AGRÈMENT



4650 S / SL

CARACTÉRISTIQUES



SH

Bandes de serrage LH



NIVEAU DE SÉCURITÉ VARIANTES



4650 SL

| Article | EAN 4003318 | a mm | b mm | c mm | d mm | e mm | Poids g | Unité emb. |
|----------------------|----------------|---------|---------|---------|---------|---------|---------|------------|
| 4650S NR black OE | 82609 2 | 80 | 100 | 70 | 60 | 108,4 | 660 | 20 |
| 4650S R black OE | 82610 8 | 80 | 100 | 70 | 60 | 108,4 | 660 | 20 |
| 4650SL NR black OE | 83575 9 | 80 | 100 | 86 | 60 | 108,4 | 640 | 20 |
| 4650SL R black OE | 83576 6 | 80 | 100 | 86 | 60 | 108,4 | 640 | 20 |
| SH485/495 | 37552 1 | | | | | | 56 | 6 |
| Bandes de serrage LH | 56240 2 | | | | | | 48 | 1 |

DONNÉES TECHNIQUES

- Anse de verrouillage de 8,5 mm d'épaisseur
- L'anse, le boîtier et les pièces de support de l'élément de fermeture sont fabriqués en acier spécialement trempé
- Système de verrouillage pour une connexion facile des accessoires dans la housse d'antivol
- Avec la version R, la clé reste dans le cylindre lorsque l'antivol est ouvert, avec la version NR, elle peut être retirée

TECHNOLOGIE



LOGOS D'AGRÈMENT



PRO TECTIC™ 4960

CARACTÉRISTIQUES



SH

Bandes de serrage LH



NIVEAU DE SÉCURITÉ VARIANTES



4960 + 6KS/85 +
ST5850

DONNÉES TECHNIQUES

- Anse en acier cémenté de 8,5 mm de diamètre
- L'anse, le boîtier et certains éléments de fermeture sont en acier spécial cémenté
- Equipé d'un système de fermeture pour attacher facilement les accessoires au corps de l'antivol
- Dans la version R (clé prisonnière), la clé Avec la version R, la clé reste dans le cylindre lorsque l'antivol est ouvert, avec la version NR, elle peut être retirée

TECHNOLOGIE



| Article | EAN | a mm | b mm | c mm | d mm | e mm | Poids g | Unité emb. |
|---------------------------------|---------|------|------|------|------|-------|---------|------------|
| 4960 NR black | 11260 7 | 76 | 96 | 69 | 57 | 107,9 | 520 | 6 |
| 4960 NR black OE | 11270 6 | 76 | 96 | 69 | 57 | 107,9 | 520 | 18 |
| 4960 NR black + 6KS/85 + ST5850 | 11263 8 | 76 | 96 | 69 | 57 | 107,9 | 1346 | 4 |
| SH485/495 | 37552 1 | | | | | | 56 | 6 |
| Bandes de serrage LH | 56240 2 | | | | | | 48 | 1 |

TECTIC™ 496

CARACTÉRISTIQUES



SH

Bandes de serrage LH

NIVEAU DE SÉCURITÉ



DONNÉES TECHNIQUES

- Anse en acier cémenté de 8,5 mm de diamètre
- L'anse, le boîtier et certains éléments de fermeture sont en acier spécial cémenté
- Avec la version R, la clé reste dans le cylindre lorsque l'antivol est ouvert, avec la version NR, elle peut être retirée

TECHNOLOGIE



| Article | EAN | a mm | b mm | c mm | d mm | e mm | Poids g | Unité emb. |
|----------------------|---------|------|------|------|------|------|---------|------------|
| 496 NR black | 11258 4 | 78 | 96 | 69 | 59 | 110 | 450 | 6 |
| 496 NR black OE | 11269 0 | 78 | 96 | 69 | 59 | 110 | 450 | 24 |
| 496 R black OE | 19457 3 | 78 | 96 | 69 | 59 | 110 | 450 | 24 |
| SH485/495 | 37552 1 | | | | | | 56 | 6 |
| Bandes de serrage LH | 56240 2 | | | | | | 48 | 1 |

Antivols de cadre et serrures de batterie

ACH 2.0 ADAPTOR CHAIN

CARACTÉRISTIQUES



ST5850





ST5950



DONNÉES TECHNIQUES

- Chaîne à maillons carrés de 6 & 8 mm en acier trempé
- Inutile de verrouiller séparément l'anse
- Diverses possibilités de connexion
- Convient à tous les antivols de cadre ABUS ainsi qu'à l'Alarmbox 2.0
- Le revêtement spécial de l'anneau du loop protège la peinture du vélo contre les dommages

| Article | EAN 4003318 |  mm |  cm | Poids g | Unité emb. |
|--------------------------------|----------------|-----------------------------------------------------------------------------------------|------------------------------------------------------------------------------------------|---------|------------|
| ACH 2.0 6KS/85 black | 95369 9 | 6 | 85 | 760 | 6 |
| ACH 2.0 6KS/85 black + ST5950 | 95371 2 | 6 | 85 | 840 | 6 |
| ACH 2.0 6KS/100 black | 95360 6 | 6 | 100 | 860 | 6 |
| ACH 2.0 6KS/100 black + ST5950 | 95363 7 | 6 | 100 | 1130 | 6 |
| ACH 2.0 6KS/130 black | 95366 8 | 6 | 130 | 1140 | 6 |
| ACH 2.0 8KS/85 black | 95375 0 | 8 | 85 | 1190 | 6 |
| ACH 2.0 8KS/85 black + ST5950 | 95376 7 | 8 | 85 | 1270 | 6 |
| ACH 2.0 8KS/100 black | 95373 6 | 8 | 100 | 1400 | 6 |
| Sac ST 5850/5650/4960 | 48647 0 | | | 100 | 1 |
| Sac ST 5950 2.0 | 87510 6 | | | | 1 |

ACL ADAPTOR CABLE

CARACTÉRISTIQUES





ST5850



DONNÉES TECHNIQUES

- Câble en acier de 12 mm
- Plusieurs possibilités de verrouillage à un point fixe
- Convient à tous les antivols de cadre ABUS ainsi qu'à l'AlarmBox 2.0

| Article | EAN 4003318 |  mm |  cm | Poids g | Unité emb. |
|-----------------------|----------------|-------------------------------------------------------------------------------------------|--------------------------------------------------------------------------------------------|---------|------------|
| ACL 12/100 black | 18243 3 | 12 | 100 | 416 | 6 |
| Sac ST 5850/5650/4960 | 48647 0 | | | 100 | 1 |

IVYTEX ADAPTOR CHAIN

CARACTÉRISTIQUES



ST5950



VARIANTES





crossing grey

DONNÉES TECHNIQUES

- Chaîne de connexion avec la gaine IvyTex
- Chaîne à profil carré fabriquée en alliage d'acier trempé par nos soins
- Le revêtement durable en fibres synthétiques IvyTex résiste aux attaques des scies
- Le revêtement hydrophobe IvyTex repousse la saleté et l'humidité
- Chaîne carrée de 6 et 8 mm d'épaisseur en acier trempé
- Gainage en tissu de l'anneau de la boucle afin de protéger la peinture contre les dommages
- Avec les antivols de cadre, aucun verrouillage séparé de l'anse n'est nécessaire
- Diverses possibilités de connexion à des objets fixes ou à plusieurs vélos
- Convient aux antivols de cadre ABUS et pour AlarmBox 2.0

TECHNOLOGIE



| Article | EAN 4003318 |  mm |  cm | Poids g | Unité emb. |
|--------------------------------|----------------|-------------------------------------------------------------------------------------------|--------------------------------------------------------------------------------------------|---------|------------|
| ACH IVY 6KS/85 black | 68457 9 | 6 | 85 | 760 | 6 |
| ACH IVY 6KS/85 crossing grey | 68456 2 | 6 | 85 | 760 | 6 |
| ACH IVY 6KS/100 black | 68460 9 | 6 | 100 | 860 | 6 |
| ACH IVY 6KS/100 black + ST5950 | 69055 6 | 6 | 100 | 1064 | 6 |
| ACH IVY 6KS/100 crossing grey | 68459 3 | 6 | 100 | 860 | 6 |
| ACH IVY 6KS/130 black | 68463 0 | 6 | 130 | 1140 | 6 |
| ACH IVY 6KS/130 crossing grey | 68462 3 | 6 | 130 | 1140 | 6 |
| ACH IVY 8KS/100 black | 68466 1 | 8 | 100 | 1400 | 4 |
| ACH IVY 8KS/100 crossing grey | 68465 4 | 8 | 100 | 1400 | 4 |
| Sac ST 5950 2.0 | 87510 6 | | | | 1 |

LES SERRURES DE BATTERIE

SERRURES DE BATTERIE

Accel Group

96518 BLO ACC IT3 T82 Service

96691 BLO ACC IT3 Xplus Service

Bafang

96306 BLO BAF 15,7 T82 Service

Bike Fun

96514 BLO BFI IT1 T82 Service

Bosch

96515 BLO BOS AX1 T82 Service

96303 BLO BOS IT2.1 T82 Service

96521 BLO BOS DT2 PLUS Service

96281 BLO BOS DT2 T82 Service

96502 BLO BOS DT2 XL T82 Service

96675 BLO BOS DT2 Xplus Service

96516 BLO BOS DT3 T82 Service

96517 BLO BOS DT3 T82 XL Service

96671 BLO BOS DT3 T83 Service

96685 BLO BOS DT3 XPLUS 2X Service

96684 BLO BOS DT3 XPLUS Service

96686 BLO BOS DT3 XPLUS XL Service

96673 BLO BOS IT2.1 Xplus Service

96301 BLO BOS IT3 T82 Service

96672 BLO BOS IT3 T83 Service

96563 BLO BOS RT2 PLUS Service

Bosch

96687 BLO BOS RT2 Xplus Service

96297 BLO BOS UNI T82 Service

Brose

96669 BLO BRO IT1 LC T83 Service

Cube

96677 BLO CUB IT1.B3 XPLUS Service

96679 BLO CUB IT2 XPLUS Service

96678 BLO CUB IT2.B3 XPLUS Service

Cycle Union

96682 BLO CYU IT1 XPLUS Service

Darfon

96300 BLO DAF UNI LC T83 Service

96513 BLO DAF UNI T82 Service

96692 BLO DAF UNI T83 Service

Fazua

96574 BLO FAZ IT1 PLUS Service

96690 BLO FAZ IT2 Xplus Service

Fit Biketec

96681 BLO FIT IT1 Xplus Service

Giant

96504 BLO GIA IT1 F T82 Service

96948 BLO GIA IT1 M T82 Service

96952 BLO GIA IT1 M XPLUS Service

Panasonic

96299 BLO PAN DT1 T82 Service

96570 BLO PAN IT1 PLUS Service

96674 BLO PAN IT1 XPLUS Service

Pexco

96577 BLO PEX IT2 PLUS Service

96565 BLO PEX IT3 PLUS Service

98414 BLO PEX IT3 XPLUS Service

Phylion

96307 BLO PHY 11,3 T82 Service

Scott

96680 BLO SCO IT2 auf IT2.1 Service

Shimano

96572 BLO SHI DT1 PLUS Service

96575 BLO SHI IT2 PLUS Service

96507 BLO SHI IT2 T82 ASY Service

96676 BLO SHI IT2 XPLUS Service

96289 BLO SHI RT1 T82 Service

Specialized

96573 BLO SPE IT2 PLUS Service

96670 BLO SPE IT3 T83 Service

96683 BLO SPE IT3 Xplus Service

Trek

96509 BLO TRE IT1 T82 Service

96984 BLO TRE IT1 PLUS Service

ZEG

96491 BLO ZEG IT1 T82 Service

96571 BLO ZEG IT3 PLUS Service

96576 BLO ZEG IT5 PLUS Service

96990 BLO ZEG IT4 XPLUS Service

98420 BLO ZEG IT5 XPLUS Service

Winora

96566 BLO+BRA WIN IT1 PLUS Service

96567 BLO+BRA WIN IT2 PLUS Service

IT: Intégré**DT: Cadre****RT: Porte-bagage**

SÉCURITÉS DIVERSES



CHAIN CLAW 10



black

Page 108

ALARMBOX 2.0



black

Page 109

ALARMBOX RC



black

Page 109

WCH90



black

Page 110

GRANIT™ WBA 100



black

Page 111

GRANIT™ WBA 75



black

Page 111

WBA 65



black

Page 112

WBA 60



black

Page 113

WA 50



black

Page 113

SPORTFLEX 2504



black

Page 114

COMBIFLEX™



black

Page 114



neon

Page 114



midnight blue

Page 114



black + CHR

Page 114

COMBIFLEX™ TRAVELGUARD



black

Page 115



yellow

Page 115



red

Page 115

COMBIFLEX™ ADVENTURE



black

Page 115

COMBILOOP 205



black

Page 116

KETTE 6 KS LOOP



black

Page 116

COBRA™



black

Page 117

1850



black

Page 117

**FEUERSTOPP
AFS625**



Page 118

PS 88



Page 118

**KEYGARAGE™
SMART 797**



Page 119

**KEYGARAGE™
SMART 787**



Page 119

**KEYGARAGE™
787 BIG LED**



Page 120

**KEYGARAGE™
787 BIG**



Page 120

**KEYGARAGE™
787 LED**



Page 121

**KEYGARAGE™
787**



Page 121

**KEYGARAGE™
797 LED**



Page 122

**KEYGARAGE™
797**



Page 122

**KEYGARAGE™
767**



Page 123

ABUS TOUCH™ 57



silber

Page 123

145



schwarz

Page 124



gelb

Page 124



orange

Page 124



rot

Page 124



lila

Page 124



blau

Page 124



grün

Page 124



silber

Page 124



titanium

Page 124

64 TITALIUM™



Page 125

70 & 70IB



70

Page 126



70IB

Page 126

**DISKUS®
24IB**



Page 126

**DISKUS®
20**



Page 127

147TSA



Page 127

CHAIN CLAW 10

NIVEAU DE SÉCURITÉ



DONNÉES TECHNIQUES

- Chaîne à maillons carrée de 7 mm d'épaisseur et de 10 cm de long
- Les articulations pivotantes et les points d'enclenchement de 55 mm de diamètre pour les menottes offrent une flexibilité maximale
- La chaîne ainsi que certaines parties du boîtier et des menottes sont fabriquées en acier spécialement cémenté
- Code à chiffres réglable individuellement

TECHNOLOGIE



| Article | EAN 4003318 |  mm |  cm | Poids g | Unité emb. |
|---------------------|----------------|-------------------------------------------------------------------------------------------|--------------------------------------------------------------------------------------------|---------|------------|
| Chain Claw 10 black | 95934 9 | 7 | 10 | 1070 | 1 |

ALARMBOX 2.0



VARIANTES



Alarmbox 2.0 black
+ 6KS/100

Alarmbox 2.0 black
+ ACL 12/100

DONNÉES TECHNIQUES

- Fonction d'alarme avec min. 100 dB pendant 15 secondes, puis réarmement
- Détection de position 3D - système d'alarme qui détecte les vibrations et les plus petits mouvements dans les trois dimensions et déclenche l'alarme
- Alarme intelligente - En cas de chocs légers et courts, par exemple avec un ballon de football, le boîtier d'alarme n'émet qu'un bref signal sonore
- Pile CR2 incluse
- Possibilité de fixation sur presque toutes les géométries rondes
- Possibilité de raccordement de chaînes et de câbles d'adaptation ABUS

TECHNOLOGIE



| Article | EAN 4003318 | Poids g | Unité emb. |
|---------------------------------|----------------|---------|------------|
| Alarmbox 2.0 noir | 61482 8 | 430 | 12 |
| Alarmbox 2.0 noir + ACH 6KS/100 | 61488 0 | 1270 | 6 |
| Alarmbox 2.0 noir + ACL 12/100 | 61489 7 | 720 | 6 |

ALARMBOX RC

CARACTÉRISTIQUES



RC



DONNÉES TECHNIQUES

- Alarmbox avec télécommande
- Fonction alarme avec min. 100 dB pendant 15 secondes, puis réarmement
- Détection de position 3D - détecte les vibrations et les moindres mouvements dans les trois dimensions et déclenche l'alarme
- Alarme intelligente - en cas de chocs légers et courts, par exemple avec un ballon de football, le boîtier d'alarme n'émet qu'un bref signal sonore
- Activation et désactivation pratiques par télécommande
- Pile CR2 incluse (Alarmbox) / Pile CR2032 incluse (télécommande)
- Possibilité de fixation sur presque toutes les géométries rondes
- Très léger et donc idéal pour une utilisation dans les domaines du sport et de l'extérieur
- Diverses options de connexion telles que les colliers de serrage, le ruban adhésif double face, le Velcro, etc.

TECHNOLOGIE



| Article | EAN 4003318 | Poids g | Unité emb. |
|--------------------------------|----------------|---------|------------|
| Alarmbox RC SingleSet schwarz | 61487 3 | 82 | 12 |
| Alarmbox RC TwinSet schwarz | 69058 7 | 164 | 12 |
| Alarmbox RC Box schwarz | 69059 4 | 70 | 12 |
| Alarmbox RC Télécommande noire | 69060 0 | 16 | 12 |

WCH90

NIVEAU DE SÉCURITÉ



CARACTÉRISTIQUES



VARIANTES



WCH90 + ACH 9KS/130



WCH90 + ACH 9KS/130

DONNÉES TECHNIQUES

- Ancre murale avec chaîne intégrée
- Boîtier en acier cémenté pour une haute résistance
- L'ancre murale est fermement ancrée dans le mur à l'aide de chevilles spéciales de haute sécurité et offre ainsi un niveau extrêmement élevé de protection contre le vol
- Les chevilles de sécurité sont incluses dans l'emballage
- Convient uniquement pour un montage mural
- La chaîne et le boîtier sont en acier spécialement cémenté
- Revêtement textile pour protéger contre les dommages causés par la peinture
- Les chaînes sont disponibles en différentes longueurs
- Cylindre ABUS XPlus pour une protection extrêmement élevée contre la manipulation, par exemple le crochitage

TECHNOLOGIE



| Article | EAN 4003318 | ⊕ | ⊖ | Poids g | Unité emb. |
|--------------------------------|----------------|---|-----|---------|------------|
| WCH90 + ACH 9KS/110 | 69061 7 | 9 | 110 | 3580 | 1 |
| WCH90 + ACH 9KS/110 Twin Chain | 69063 1 | 9 | 110 | 6620 | 1 |
| WCH90 + ACH 9KS/130 | 69062 4 | 9 | 130 | 3960 | 1 |

WBA100 GRANIT™

CARACTÉRISTIQUES



NIVEAU DE SÉCURITÉ



Niveau de Sécurité
Moto



DONNÉES TECHNIQUES

- Oeillet en acier spécial cimenté de 16 mm de diamètre extrêmement résistant
- Accessoires de montage inclus

LOGOS D'AGRÈMENT



| Article | EAN 4003318 | mm | mm | mm | mm | mm | Poids g | Unité emb. |
|----------------|----------------|-----|-----|----|----|----|---------|------------|
| WBA100 GRANIT™ | 27161 8 | 160 | 165 | 16 | 65 | 77 | 1880 | 1 |

WBA75 GRANIT™

CARACTÉRISTIQUES



NIVEAU DE SÉCURITÉ



DONNÉES TECHNIQUES

- Oeillet en acier spécial cimenté de 14 mm de diamètre, extrêmement résistant
- Accessoires de montage inclus

LOGOS D'AGRÈMENT



| Article | EAN 4003318 | mm | mm | mm | mm | mm | Poids g | Unité emb. |
|---------------|----------------|-----|----|----|----|----|---------|------------|
| WBA75 GRANIT™ | 78606 8 | 135 | 98 | 14 | 57 | 65 | 850 | 1 |

WBA65





★
NEW

DONNÉES TECHNIQUES

- Anse de 10 mm d'épaisseur
- Support pour la roue arrière
- Montage simple sans cheville

NIVEAU DE SÉCURITÉ



| Article | EAN |  mm |  mm |  mm |  mm |  mm | Poids g | Unité emb. |
|----------------------------|---------|--------------------------------------------------------------------------------------|--------------------------------------------------------------------------------------|--------------------------------------------------------------------------------------|---------------------------------------------------------------------------------------|----------------------------------------------------------------------------------------|---------|------------|
| WBA65 B/SB + SUPPORT MURAL | 97167 9 | 118 | 80 | | | | 1094 | |



WBA60

CARACTÉRISTIQUES



DONNÉES TECHNIQUES

- Oeillet en acier spécial cémenté de 10 mm de diamètre, extrêmement résistant
- Accessoires de montage inclus

NIVEAU DE SÉCURITÉ



LOGOS D'AGRÈMENT



| Article | EAN |  |  |  |  |  | Poids g | Unité emb. |
|---------|---------|-----------------------------------------------------------------------------------|-----------------------------------------------------------------------------------|-----------------------------------------------------------------------------------|------------------------------------------------------------------------------------|-------------------------------------------------------------------------------------|---------|------------|
| | | mm | mm | mm | mm | mm | | |
| WBA60 | 82211 7 | 118 | 80 | 10 | 52 | 55 | 450 | 1 |

WA50

CARACTÉRISTIQUES



DONNÉES TECHNIQUES

- Ancre murale solide faite en acier cémenté
- Accessoires de montage inclus

NIVEAU DE SÉCURITÉ



| Article | EAN |  |  |  |  |  | Poids g | Unité emb. |
|---------|---------|-------------------------------------------------------------------------------------|-------------------------------------------------------------------------------------|-------------------------------------------------------------------------------------|--------------------------------------------------------------------------------------|---------------------------------------------------------------------------------------|---------|------------|
| | | mm | mm | mm | mm | mm | | |
| WA50 | 04294 2 | 80 | 110 | | 38 | 38 | 786 | 1 |

SPORTFLEX 2504





DONNÉES TECHNIQUES

- Antivol à câble très léger et peu encombrant à monter sous le porte-bidon
- Montage à l'aide de deux vis incluses dans l'emballage aux points de fixation sur le tube du cadre du vélo
- Le profil bas de 20 mm permet le montage sous un porte-bidon existant
- Câble auto-rétractable
- Code à chiffres réglable individuellement
- Idéal pour la protection contre les pickpockets et les voleurs occasionnels

TECHNOLOGIE



| Article | EAN 4003318 |  mm |  cm | Poids g | Unité emb. |
|---------|----------------|-----------------------------------------------------------------------------------------|------------------------------------------------------------------------------------------|---------|------------|
| 2504/90 | 69054 9 | 2,4 | 90 | 100 | 1 |

COMBIFLEX™



DONNÉES TECHNIQUES

- Câble auto-rétractable
- Le code numérique est réglable et modifiable par l'utilisateur
- Format de poche attrayant qui se glisse facilement dans une poche
- Câble en acier extensible

TECHNOLOGIE



VARIANTES





neon



midnight blue



black + CHR

| Article | EAN 4003318 |  mm |  cm | Poids g | Unité emb. |
|--------------------------------------|----------------|-------------------------------------------------------------------------------------------|--------------------------------------------------------------------------------------------|---------|------------|
| Combiflex™ StopOver 65 black | 95454 2 | 1,2 | 65 | 46 | 1 |
| Combiflex™ StopOver 65 neon | 95458 0 | 1,2 | 65 | 46 | 1 |
| Combiflex™ StopOver 65 midnight blue | 95459 7 | 1,2 | 65 | 46 | 1 |
| Combiflex™ Break 85 black | 95455 9 | 1,5 | 85 | 58 | 1 |
| Combiflex™ Break 85 neon | 95460 3 | 1,5 | 85 | 58 | 1 |
| Combiflex™ Break 85 midnight blue | 95461 0 | 1,5 | 85 | 58 | 1 |
| Combiflex™ Rest 105 black | 95456 6 | 2,4 | 80 | 85 | 1 |
| Combiflex™ Rest 105 black + CHR | 95484 9 | 2,4 | 120 | 96 | 1 |
| Combiflex™ Trip 125 black | 95457 3 | 3 | 125 | 128 | 1 |

COMBIFLEX™ TRAVELGUARD





VARIANTES



black



yellow

| Article | EAN 4003318 |  mm |  cm | Poids g | Unité emb. |
|--------------------|----------------|-----------------------------------------------------------------------------------------|------------------------------------------------------------------------------------------|---------|------------|
| TravelGuard black | 95468 9 | 4 | 45 | 80 | 1 |
| TravelGuard yellow | 95601 0 | 4 | 45 | 80 | 1 |
| TravelGuard red | 95600 3 | 4 | 45 | 80 | 1 |

DONNÉES TECHNIQUES

- Protection de câble avec armature en acier extra solide
- Code numérique à 3 chiffres réglable et modifiable par l'utilisateur
- Sécurité du câble avec mécanisme de fermeture amovible
- Petit et léger, se glisse facilement dans la poche du pantalon ou du maillot

TECHNOLOGIE



COMBIFLEX™ ADVENTURE





DONNÉES TECHNIQUES

- Antivol à câble compact avec câble rétractable
- Code numérique à 3 chiffres réglable et modifiable par l'utilisateur
- Format de poche attrayant qui se glisse facilement dans une poche
- Câble en acier de 4 mm de diamètre et 75 cm de long

TECHNOLOGIE



| Article | EAN 4003318 |  mm |  cm | Poids g | Unité emb. |
|----------------------------|----------------|-------------------------------------------------------------------------------------------|--------------------------------------------------------------------------------------------|---------|------------|
| Combiflex™ Adventure black | 95465 8 | 4 | 75 | 90 | 1 |

COMBILoop 205



DONNÉES TECHNIQUES

- Câble de 5 mm en acier solide
- Revêtement synthétique pour protéger la peinture du vélo
- Fermeture automatique à l'insertion du boulon de verrouillage
- Programmation individuelle du code

TECHNOLOGIE



NIVEAU DE SÉCURITÉ



| Article | EAN 4003318 |  mm |  cm | Poids g | Unité emb. |
|---------------|----------------|-----------------------------------------------------------------------------------------|------------------------------------------------------------------------------------------|---------|------------|
| 205/200 black | 52523 0 | 5 | 200 | 180 | 12 |



CHAÎNE 6KS LOOP



DONNÉES TECHNIQUES

- Chaîne carrée de 6 mm de diamètre en acier spécial
- Diamètre des anneaux Loop: 30 mm et 50 mm
- Une gaine textile autour de la chaîne et un revêtement plastique de l'anneau de 50 mm protègent la peinture des dommages
- Disponible en deux longueurs : 100 cm et 140 cm





| Article | EAN 4003318 |  mm |  cm | Poids g | Unité emb. |
|--------------------|----------------|-------------------------------------------------------------------------------------------|--------------------------------------------------------------------------------------------|---------|------------|
| Chaîne 6KS100 Loop | 97023 8 | 6 | 100 | 860 | 6 |
| Chaîne 6KS140 Loop | 97024 5 | 6 | 140 | 1220 | 6 |



DONNÉES TECHNIQUES

- Câble en acier de haute qualité, terminé par deux boucles de chaque côté
- Revêtement synthétique pour protéger contre tout incidents

| Article | EAN 4003318 |  mm |  cm | Poids g | Unité emb. |
|----------------------|----------------|-----------------------------------------------------------------------------------------|------------------------------------------------------------------------------------------|---------|------------|
| Cobra™ 5/75 black | 37106 6 | 5 | 75 | 75 | 100 |
| Cobra™ 8/200 black | 25718 6 | 8 | 200 | 280 | 1 |
| Cobra™ 8/250 black | 27390 2 | 8 | 250 | 395 | 16 |
| Cobra™ 10/140 black | 37107 3 | 10 | 140 | 310 | 30 |
| Cobra™ 10/200 black | 11167 9 | 10 | 200 | 400 | 1 |
| Cobra™ 10/220 black | 37108 0 | 10 | 220 | 420 | 24 |
| Cobra™ 10/300 black | 59930 9 | 10 | 300 | 560 | 21 |
| Cobra™ 10/500 black | 20780 8 | 10 | 500 | 850 | 1 |
| Cobra™ 10/1000 black | 20781 5 | 10 | 1000 | 1580 | 1 |
| Cobra™ 12/120 black | 25719 3 | 12 | 120 | 380 | 1 |
| Cobra™ 12/180 black | 27391 9 | 12 | 180 | 490 | 15 |

1850



DONNÉES TECHNIQUES

- Câble en acier de haute qualité, terminé par deux boucles de chaque côté
- Revêtement synthétique pour protéger contre tout incidents

| Article | EAN 4003318 |  mm |  cm | Poids g | Unité emb. |
|----------|----------------|-------------------------------------------------------------------------------------------|--------------------------------------------------------------------------------------------|---------|------------|
| 1850/185 | 12752 6 | 8 | 185 | 280 | 18 |

AFS625



DONNÉES TECHNIQUES

- 625 ml d'agent d'extinction moussant ultra efficace
- Utilisation facile - fonctionnement similaire à celui d'une bombe aérosol classique
- Distance de pulvérisation (distance max. entre foyer d'incendie et utilisateur) jusqu'à 4 m
- Durée de pulvérisation env. 25 secondes
- Poids : env. 900 g brut
- Adapté pour l'extinction de débuts d'incendies des classes de feu A, B et F
- Classe de feu 5A : matériaux solides et non liquéfiables
- Classe de feu 21B : matériaux liquides et liquéfiables
- Classe de feu 15F : graisses et huiles alimentaires
- Convient également pour les installations électriques jusqu'à 1 000 V (distance min. : 1 m)

ACCESSOIRES



| Article | EAN 4003318 | Poids g | Unité emb. |
|-----------------------|----------------|---------|------------|
| AFS625 | 85727 0 | 847 | 6 |
| Support AFS625/FLS580 | 56249 5 | 81 | 1 |

PS88



DONNÉES TECHNIQUES

- Lubrifiant adapté aux cylindres de portes, cylindres de cadenas pour vélos, cylindres de cadenas, serrures de voitures, outils, équipements sportifs, machines de bureau
- Produit spécial non gras

VARIANTES



| Article | EAN 4003318 | Poids g | Unité emb. | Exécution |
|-----------------|----------------|---------|------------|--------------------|
| PS88 50ml D | 00117 8 | 59 | 1 | 50 ml aerosol can |
| PS88 125ml D | 07010 5 | 124 | 1 | 125 ml aerosol can |
| PS88 300ml D | 84408 9 | 301 | 1 | 300 ml aerosol can |
| VK PS88 50ml D | 08217 7 | 60 | 1 | 24 x 50 ml |
| VK PS88 125ml D | 06952 9 | 124 | 1 | 12 x 125 ml |
| VK PS88 300ml D | 84409 6 | 3900 | 1 | 12 x 300 ml |

797 SMART BLUETOOTH®



TECHNOLOGIE



DONNÉES TECHNIQUES

- Grand boîtier métallique solide
- Clavier électronique éclairé pour la saisie d'un code à 6 chiffres
- Gestion et utilisation de KeyGarage™ via l'application HomeTec Pro Bluetooth
- Génération d'un code d'accès à 6 caractères pour plusieurs utilisateurs
- Visualisation de l'historique de connexion et des utilisateurs actuels
- Permet de déposer jusqu'à 20 clés, 3 clés de voiture ou 30 cartes plastique
- Crochet à clés intégré pour suspendre des clés/des trousseaux de clés
- Verrouillage automatique
- Compartiment à pile pour 2 x piles AA, accessible de l'extérieur
- Pour le stockage sécurisé de clés ou de petits objets de valeur pour les personnes autorisées
- Accès rapide et facile pour des groupes de personnes changeant fréquemment (p. ex artisans, assistance, vacanciers, location de véhicules, immeubles, service infirmier)
- Possibilité d'accès grâce à la génération et la transmission d'un code chiffré ou via l'envoi d'un ticket d'accès électronique grâce à l'application Bluetooth HomeTec Pro
- Fixation avec anse pour une utilisation flexible et temporaire dans une zone intérieure ou extérieure sous abri (p. ex. sur une poignée de porte, une rambarde ou une poignée)
- Rangement des trousseaux de clés complets possible grâce au grand compartiment intérieur

| Article | EAN 4003318 |  mm |  mm |  mm | Poids g | Unité emb. |
|------------------------|----------------|-------------------------------------------------------------------------------------------|--------------------------------------------------------------------------------------------|---------------------------------------------------------------------------------------------|---------|------------|
| 797 SMART-BT avec anse | 63825 1 | 82,5 | 63 | 179 | 888 | 1 |

787 SMART BLUETOOTH®



TECHNOLOGIE



DONNÉES TECHNIQUES

- Grand boîtier métallique solide
- Clavier électronique éclairé pour la saisie d'un code à 6 chiffres
- Gestion et utilisation de KeyGarage™ via l'application HomeTec Pro Bluetooth
- Génération d'un code d'accès à 6 caractères pour plusieurs utilisateurs
- Visualisation de l'historique de connexion et des utilisateurs actuels
- Permet de déposer jusqu'à 20 clés, 3 clés de voiture ou 30 cartes plastique
- Crochet à clés intégré pour suspendre des clés/des trousseaux de clés
- Verrouillage automatique
- Compartiment à pile pour 2 x piles AA, accessible de l'extérieur
- Pour le stockage sécurisé de clés ou de petits objets de valeur pour les personnes autorisées
- Accès rapide et facile pour des groupes de personnes changeant fréquemment (p. ex artisans, assistance, vacanciers, location de véhicules, immeubles, service infirmier)
- Possibilité d'accès grâce à la génération et la transmission d'un code chiffré ou via l'envoi d'un ticket d'accès électronique grâce à l'application Bluetooth HomeTec Pro
- Pour un montage mural en intérieur ou en extérieur sous abri
- Rangement des trousseaux de clés complets possible grâce au grand compartiment intérieur

| Article | EAN 4003318 |  mm |  mm |  mm | Poids g | Unité emb. |
|----------------------------|----------------|-------------------------------------------------------------------------------------------|--------------------------------------------------------------------------------------------|---------------------------------------------------------------------------------------------|---------|------------|
| 787 SMART-BT montage mural | 63824 4 | 82,5 | 63 | 120 | 883 | 1 |

787 BIG LED KEYGARAGE™



TECHNOLOGIE



DONNÉES TECHNIQUES

- Boîtier métallique solide
- Clapet en zinc moulé sous pression avec molettes à chiffres
- Code à 4 chiffres personnalisables
- Molette à chiffres éclairée pour une meilleure lisibilité dans les environnements sombres
- Les LED s'allument pendant env. 30 secondes
- Pile bouton standard (CR2032) facile à remplacer, durée de vie en utilisation normale (1x/Jour) : env. 2 ans
- Clapet de protection avec mécanisme coulissant
- Montage mural avec des vis
- Permet de déposer jusqu'à 14 cartes plastiques ou 20 clés (787 LED) ou jusqu'à 30 cartes plastiques ou 50 clés (787 BIG LED)
- Crochet à clés amovible pour plus de confort lors du rangement des clés
- Dimensions extérieures du boîtier : 84 x 120 x 42 (787 LED) / 84 x 120 x 62 (787 BIG LED)
- Pour le stockage sécurisé de clés ou de petits objets de valeur pour les personnes autorisées
- Accès rapide et facile pour des groupes de personnes changeant fréquemment (artisans, assistance, vacanciers, immeubles, location de vélos)
- Possibilité d'accès en définissant et transmettant le code à chiffres
- Pour un montage encastré en intérieur ou en extérieur sous abri
- Le stockage d'un trousseau clés est possible grâce à un plus grand espace et à un crochet amovible

Article

EAN
4003318



mm



mm



mm

Poids g

Unité emb.

787 BIG LED montage mural

83856 9

84

62

120

721

1

787 BIG KEYGARAGE™



TECHNOLOGIE



DONNÉES TECHNIQUES

- Boîtier métallique solide
- Clapet en zinc coulé sous pression
- Combinaison à 4 chiffres à programmation individuelle
- Clapet d'ouverture coulissant
- Fixation murale avec des vis
- Permet de déposer 30 cartes ou 50 clés
- Le crochet de clé peut être enlevé
- Très large espace de rangement
- Dimensions extérieures du boîtier : 84 x 120 x 62
- Pour la conservation de clés p. ex. pour les personnes autorisées
- Accès rapide et facile pour des groupes de personnes changeant fréquemment (artisans, assistance, vacanciers, immeubles, location de vélos)
- Détermination de la possibilité d'accès en choisissant et transmettant le code à chiffres
- Pour montage mural en intérieur ou en extérieur dans une zone protégée
- Exemple: Dépôt de clés ou de cartes plastiques à code

Article

EAN
4003318



mm



mm



mm

Poids g

Unité emb.

787 BIG montage mural

08492 8

83,5

62

120

841

1

787 LED KEYGARAGE™





TECHNOLOGIE



DONNÉES TECHNIQUES

- Boîtier métallique solide
- Clapet en zinc moulé sous pression avec molettes à chiffres
- Code à 4 chiffres personnalisables
- Molette à chiffres éclairée pour une meilleure lisibilité dans les environnements sombres
- Les LED s'allument pendant env. 30 secondes
- Pile bouton standard (CR2032) facile à remplacer, durée de vie en utilisation normale (1x/jour) : env. 2 ans
- Clapet de protection avec mécanisme coulissant
- Montage mural avec des vis
- Permet de déposer jusqu'à 14 cartes plastiques ou 20 clés (787 LED) ou jusqu'à 30 cartes plastiques ou 50 clés (787 BIG LED)
- Crochet à clés amovible pour plus de confort lors du rangement des clés
- Dimensions extérieures du boîtier : 84 x 120 x 42 (787 LED) / 84 x 120 x 62 (787 BIG LED)
- Pour le stockage sécurisé de clés ou de petits objets de valeur pour les personnes autorisées
- Accès rapide et facile pour des groupes de personnes changeant fréquemment (artisans, assistance, vacanciers,, immeubles, location de vélos)
- Possibilité d'accès en définissant et transmettant le code à chiffres
- Pour un montage encastré en intérieur ou en extérieur sous abri
- Le stockage d'un trousseau clés est possible grâce à un plus grand espace et à un crochet amovible

| Article | EAN 4003318 |  mm |  mm |  mm | Poids g | Unité emb. |
|-----------------------|----------------|-------------------------------------------------------------------------------------------|-------------------------------------------------------------------------------------------|---------------------------------------------------------------------------------------------|---------|------------|
| 787 LED montage mural | 83854 5 | 84 | 42 | 120 | 698 | 1 |

787 KEYGARAGE™





TECHNOLOGIE



DONNÉES TECHNIQUES

- Boîtier métallique robuste
- Clapet en zinc coulé sous pression
- Code personnalisable à 4 chiffres
- Clapet de protection avec mécanisme coulissant
- Fixation murale avec des vis
- Permet de déposer 14 cartes ou 20 clés
- Dimensions extérieures du boîtier : 80 x 120 x 45
- Crochet à clés amovible pour plus de confort lors du rangement des clés
- Pour la conservation de clés p. ex. pour les personnes autorisées
- Accès rapide et facile pour des groupes de personnes changeant fréquemment (artisans, assistance, vacanciers, immeubles, location de vélos)
- Détermination de la possibilité d'accès en choisissant et transmettant le code à chiffres
- Pour montage mural, en intérieur comme en extérieur sous abri

| Article | EAN 4003318 |  mm |  mm |  mm | Poids g | Unité emb. |
|-------------------|----------------|-------------------------------------------------------------------------------------------|-------------------------------------------------------------------------------------------|---------------------------------------------------------------------------------------------|---------|------------|
| 787 montage mural | 46331 0 | 80 | 45 | 120 | 690 | 1 |

797 LED KEYGARAGE™





CARACTÉRISTIQUES



Adaptateur

TECHNOLOGIE



| Article | EAN 4003318 |  mm |  mm |  mm | Poids g | Unité emb. |
|---------------------------------|----------------|-----------------------------------------------------------------------------------------|-----------------------------------------------------------------------------------------|-------------------------------------------------------------------------------------------|---------|------------|
| 797 LED avec anse | 83855 2 | 84 | 44 | 120 | 779 | 1 |
| Adaptateur KeyGarage™ 777 + 797 | 56321 8 | 70 | 74 | 63 | 114 | 1 |

DONNÉES TECHNIQUES

- Boîtier en métal solide
- Clapet en zinc moulé sous pression
- Code à 4 chiffres personnalisables
- Molette à chiffres éclairée pour une meilleure lisibilité dans les environnements sombres
- Les LED s'allument pendant env. 30 secondes
- Pile bouton standard (CR2032) facile à remplacer, durée de vie en utilisation normale (1x/jour) : env. 2 ans
- Clapet de protection avec mécanisme coulissant
- Avec anse pour une fixation sur la poignée de porte p. ex.
- Capacité de stockage de 14 cartes ou 20 clés
- Dimensions extérieures du boîtier : 84 x 120 x 44
- Boîtier et anse avec revêtement en plastique pour protéger des rayures
- Pour le stockage sécurisé de clés ou de petits objets de valeur pour les personnes autorisées
- Accès rapide et facile pour des groupes de personnes changeant fréquemment (artisans, assistance, vacanciers, immeubles, location de vélos)
- Possibilité d'accès en définissant et transmettant le code à chiffres
- Fixation avec l'anse pour une utilisation flexible et temporaire, p. ex. sur une poignée de porte, une rambarde ou une poignée

797 KEYGARAGE™





CARACTÉRISTIQUES



Adaptateur

TECHNOLOGIE



| Article | EAN 4003318 |  mm |  mm |  mm | Poids g | Unité emb. |
|---------------------------------|----------------|-------------------------------------------------------------------------------------------|-------------------------------------------------------------------------------------------|---------------------------------------------------------------------------------------------|---------|------------|
| 797 avec anse | 46330 3 | 85 | 45 | 180 | 767 | 1 |
| Adaptateur KeyGarage™ 777 + 797 | 56321 8 | 70 | 74 | 63 | 114 | 1 |

DONNÉES TECHNIQUES

- Boîtier métallique robuste
- Clapet en zinc coulé sous pression
- Code personnalisable à 4 chiffres
- Clapet de protection avec mécanisme coulissant
- Avec anse pour une fixation sur la poignée de porte p. ex.
- Permet de déposer 14 cartes ou 20 clés
- Dimensions extérieures du boîtier: 85 x 120 x 45
- Boîtier et anse recouverts de la matière plastique protégée ainsi votre porte des rayures
- Pour la conservation de clés p. ex. pour les personnes autorisées
- Accès rapide et facile pour des groupes de personnes changeant fréquemment (artisans, assistance, vacanciers, immeubles, location de vélos)
- Détermination de la possibilité d'accès en choisissant et transmettant le code à chiffres
- Fixation avec anse p. ex. aux boutons de porte, aux poignées ou aux poignées en étrier

767 KEYGARAGE™





TECHNOLOGIE



DONNÉES TECHNIQUES

- Boîtier métallique robuste
- Clapet en zinc coulé sous pression
- Combinaison interchangeable à 10 codes bouton-poussoir: Mettez votre code personnel
- Le code à chiffres doit également être saisi pour fermer le capuchon de fermeture
- Clapet d'ouverture coulissant
- Pour un montage au mur, à l'aide des vis
- Permet de déposer 17 cartes ou 20 clés
- Dimensions extérieures du boîtier: 84 x 119 x 47
- Pour la conservation de clés p. ex. pour les personnes autorisées
- Accès rapide et facile pour des groupes de personnes changeant fréquemment (artisans, assistance, vacanciers, immeubles, location de vélos)
- Détermination de la possibilité d'accès en choisissant et transmettant le code à chiffres
- Pour montage mural, en intérieur comme en extérieur sous abri







| Article | EAN 4003318 |  mm |  mm |  mm | Poids g | Unité emb. |
|-------------------|----------------|-----------------------------------------------------------------------------------------|-----------------------------------------------------------------------------------------|-------------------------------------------------------------------------------------------|---------|------------|
| 767 montage mural | 53507 9 | 80 | 45 | 120 | 657 | 1 |

ABUS TOUCH™ 57



DONNÉES TECHNIQUES

- Corps du cadenas en zamak revêtu
- Anse Nano Protect™ en acier trempé
- Pile CR2
- Capteur capacitif avec reconnaissance précise
- Possibilité d'enregistrer 20 empreintes digitales
- Anse verrouillée des deux côtés
- Verrouillage automatique
- Anse montée sur ressort pour une ouverture automatique
- Certification IP IP66 & IP68
- Sécuriser les valeurs moyennes en cas de risque de vol moyen
- Utilisation dans des zones propres avec une bonne reconnaissance de l'empreinte digitale
- Convient pour une utilisation en intérieur et en extérieur

| Article | EAN 4003318 |  mm |  mm |  mm |  mm |  mm |  mm | Poids g | Unité emb. |
|---------|----------------|-------------------------------------------------------------------------------------------|-------------------------------------------------------------------------------------------|-------------------------------------------------------------------------------------------|-------------------------------------------------------------------------------------------|---------------------------------------------------------------------------------------------|---------------------------------------------------------------------------------------------|---------|------------|
| 57/45 | 62575 6 | 45 | 20 | 30 | 6,5 | 23 | 95 | 317 | 1 |
| 57/50 | 62581 7 | 50 | 24 | 36 | 8 | 23 | 103 | 390 | 1 |



DONNÉES TECHNIQUES

- Boîtier de cadenas massif en aluminium à revêtement anodisé – résistant à la corrosion
- L'anse est sur ressort pour un meilleur ajustement de la combinaison d'ouverture
- 145/20 et 145/30: Code individuel personnalisable à 3 chiffres
- 145/40: Code individuel personnalisable à 4 chiffres
- Utilisation confortable sans clé, poids faible
- Grande facilité d'identification grâce aux couleurs vives
- 145/20 et 145/30: Protection d'objets de petite valeur ou avec un risque de vol faible
- 145/40: Protection d'objets de moyenne valeur / d'objets avec un risque de vol moyen
- Par exemple pour la protection de bagages, de casiers dans les écoles et les centres sportifs, de cassettes, de coffres, de caisses à outils, d'installations électriques, etc.

VARIANTES



145/20 yellow



145/20 orange



145/20 red



145/20 violet



145/20 blue



145/20 green



145/20 silver



145/20 titanium

| Article | EAN 4003318 | mm | mm | mm | mm | mm | mm | Poids g | Unité emb. |
|-----------------------|----------------|------|------|----|----|------|------|---------|------------|
| 145/20 jaune B/DFNLI | 46552 9 | 22,5 | 9 | 22 | 3 | 13,5 | 52,5 | 25 | 6 |
| 145/20 orange B/DFNLI | 46550 5 | 22,5 | 9 | 22 | 3 | 13,5 | 52,5 | 23 | 6 |
| 145/20 rouge B/DFNLI | 46549 9 | 22,5 | 9 | 22 | 3 | 13,5 | 52,5 | 25 | 6 |
| 145/20 violet B/DFNLI | 46553 6 | 22,5 | 9 | 22 | 3 | 13,5 | 52,5 | 25 | 6 |
| 145/20 bleu B/DFNLI | 46548 2 | 22,5 | 9 | 22 | 3 | 13,5 | 52,5 | 23 | 6 |
| 145/20 vert B/DFNLI | 46551 2 | 22,5 | 9 | 22 | 3 | 13,5 | 52,5 | 25 | 6 |
| 145/20 argent B/DFNLI | 46554 3 | 22,5 | 9 | 22 | 3 | 13,5 | 52,5 | 25 | 6 |
| 145/20 titane B/DFNLI | 46556 7 | 22,5 | 9 | 22 | 3 | 13,5 | 52,5 | 23 | 6 |
| 145/20 noir B/DFNLI | 34609 5 | 22,5 | 9 | 22 | 3 | 13,5 | 52,5 | 23 | 6 |
| 145/30 jaune B/DFNLI | 46561 1 | 31,5 | 14 | 25 | 5 | 15,5 | 65 | 52 | 6 |
| 145/30 orange B/DFNLI | 46559 8 | 31,5 | 14 | 25 | 5 | 15,5 | 65 | 52 | 6 |
| 145/30 rouge B/DFNLI | 46558 1 | 31,5 | 14 | 25 | 5 | 15,5 | 65 | 52 | 6 |
| 145/30 violet B/DFNLI | 46562 8 | 31,5 | 14 | 25 | 5 | 15,5 | 65 | 52 | 6 |
| 145/30 bleu B/DFNLI | 46557 4 | 31,5 | 14 | 25 | 5 | 15,5 | 65 | 52 | 6 |
| 145/30 vert B/DFNLI | 46560 4 | 31,5 | 14 | 25 | 5 | 15,5 | 65 | 52 | 6 |
| 145/30 argent B/DFNLI | 46563 5 | 31,5 | 14 | 25 | 5 | 15,5 | 65 | 52 | 6 |
| 145/30 titane B/DFNLI | 46565 9 | 31,5 | 14 | 25 | 5 | 15,5 | 65 | 52 | 6 |
| 145/30 noir B/DFNLI | 34610 1 | 31,5 | 14 | 25 | 5 | 15,5 | 65 | 52 | 6 |
| 145/40 jaune B/DFNLI | 49534 2 | 41,5 | 21,5 | 26 | 6 | 17,5 | 77 | 105 | 6 |
| 145/40 orange B/DFNLI | 49526 7 | 41,5 | 21,5 | 26 | 6 | 17,5 | 77 | 103 | 6 |
| 145/40 rouge B/DFNLI | 48830 6 | 41,5 | 21,5 | 26 | 6 | 17,5 | 77 | 110 | 6 |
| 145/40 bleu B/DFNLI | 49522 9 | 41,5 | 21,5 | 26 | 6 | 17,5 | 77 | 105 | 6 |
| 145/40 vert B/DFNLI | 49530 4 | 41,5 | 21,5 | 26 | 6 | 17,5 | 77 | 105 | 6 |
| 145/40 argent B/DFNLI | 49542 7 | 41,5 | 21,5 | 26 | 6 | 17,5 | 77 | 105 | 6 |
| 145/40 titane B/DFNLI | 49550 2 | 41,5 | 21,5 | 26 | 6 | 17,5 | 77 | 105 | 6 |

64 TITALIUM™



DONNÉES TECHNIQUES

- Corps de cadenas massif en aluminium spécial TITALIUM™
- Anse en acier spécial cémenté avec revêtement NANO PROTECT™ pour une meilleure résistance à la corrosion
- 64TI/50HB60-150: Anse amovible et de taille réglable entre 60 et 150 mm
- Profil de clé paracentrique pour une protection élevée contre les effractions
- Double verrouillage de l'anse
- Cœur du cylindre chromé pour une protection accrue contre la corrosion
- Tête de clé en forme de tulipe
- Protection d'objets de moyenne valeur ou présentant un risque de vol moyen
- Pour la sécurisation de chaînes, de portes, de portails, d'armoires, de casiers, de boîtes à outils, de fenêtres de cave ou de remises.

VARIANTES



64TI/20 B/DFNLI



64TI/25 B/DFNLI



64TI/30 B/DFNLI



64TI/30HB60 B/DFNLI



64TI/35 B/DFNLI









64TI/40HB40 B/DFNLI



64TI/40HB63 B/DFNLI



64TI/45 B/DFNLI

| Article | EAN 4003318 |  |  |  |  |  |  | Poids g | Unité emb. |
|-------------------------|----------------|-------------------------------------------------------------------------------------|-------------------------------------------------------------------------------------|-------------------------------------------------------------------------------------|-------------------------------------------------------------------------------------|---------------------------------------------------------------------------------------|---------------------------------------------------------------------------------------|---------|------------|
| | | mm | mm | mm | mm | mm | mm | | |
| 64TI/20 B/DFNLI | 56384 3 | 20 | 9,5 | 11,5 | 3,5 | 10,5 | 34 | 22 | 6 |
| 64TI/25 B/DFNLI | 56386 7 | 24,5 | 13 | 13,5 | 4 | 12 | 42 | 31 | 6 |
| 64TI/30 B/DFNLI | 56387 4 | 30 | 16 | 17 | 5 | 13 | 50 | 54 | 6 |
| 64TI/30HB60 B/DFNLI | 56388 1 | 30 | 16 | 60 | 5 | 13 | 93 | 66 | 6 |
| 64TI/35 B/DFNLI | 56390 4 | 35 | 19 | 20 | 5,5 | 14 | 54 | 67 | 6 |
| 64TI/40 B/DFNLI | 56391 1 | 40 | 22 | 23 | 6 | 15 | 62 | 88 | 6 |
| 64TI/40HB40 B/DFNLI | 56392 8 | 40 | 22 | 40 | 6 | 15 | 79 | 96 | 6 |
| 64TI/40HB63 B/DFNLI | 56393 5 | 40 | 22 | 63 | 6 | 15 | 102 | 107 | 6 |
| 64TI/45 B/DFNLI | 56398 0 | 45 | 25 | 24 | 7 | 15 | 68 | 110 | 6 |
| 64TI/50 B/DFNLI | 56399 7 | 50 | 28 | 29 | 8 | 17 | 77 | 159 | 6 |
| 64TI/50HB80 B/DFNLI | 56400 0 | 50 | 28 | 80 | 8 | 17 | 128 | 199 | 6 |
| 64TI/50HB60-150 B/DFNLI | 89490 9 | 50 | 28 | 60-150 | 8 | 17 | 77 | 281 | 4 |
| 64TI/50HB60-150 gl. | 63308 9 | 50 | 28 | 60-150 | 8 | 17 | 77 | 281 | 3 |
| 64TI/60 B/DFNLI | 56401 7 | 60 | 34 | 35 | 10 | 19 | 91 | 234 | 4 |

70 EXPEDITION



DONNÉES TECHNIQUES

- Boîtier en laiton massif
- Anse en acier trempé avec gaine plastique
- Boîtier encapsulé avec clapet protecteur spécial et canaux de drainage pour la protection de la serrure contre l'eau et la saleté
- Une gaine plastique résiliente protège les surfaces sensibles
- Double verrouillage
- Cylindre à goupilles de précision
- Profil de clé paracentrique pour une protection élevée contre les effractions
- Pièces intérieures en matériaux inoxydables
- Verrouillage automatique: verrouillage sans clé par enfoncement de l'anse
- Protection d'objets de moyenne valeur ou avec un risque de vol modéré
- Pour la protection de chaînes, portes, portails, armoires, casiers, caisses à outils, soupiraux, hangars, installations électriques ...
- Convient également pour une utilisation en extérieur

CARACTÉRISTIQUES

VARIANTES



70/45HB63



70IB/45



70IB/50



70IB/45HB63

| Article | EAN 4003318 | | | | | | | Poids g | Unité emb. |
|---------------------|----------------|----|------|------|----|------|------|---------|------------|
| | | mm | mm | mm | mm | mm | mm | | |
| 70/45 B/DFNLI | 32130 6 | 49 | 20 | 24 | 8 | 27,5 | 74 | 179 | 6 |
| 70/45HB63 B/DFNLI | 32131 3 | 49 | 20 | 63 | 8 | 27,5 | 112 | 201 | 6 |
| 70IB/45 B/DFNLI | 32132 0 | 49 | 20 | 24 | 8 | 27,5 | 74 | 179 | 6 |
| 70IB/45HB63 B/DFNLI | 35834 0 | 49 | 20 | 63 | 8 | 27,5 | 112 | 200 | 6 |
| 70IB/50 B/DFNLI | 42733 6 | 55 | 23,5 | 27,5 | 9 | 31 | 81,5 | 233 | 6 |

24IB DISKUS®



DONNÉES TECHNIQUES

- Boîtier, intérieur et anse intégralement en acier inoxydable pour une protection anti-corrosion maximale
- Masquage des cylindres - protection maximale contre la saleté et les projections d'eau (uniquement pour 60 et 70 mm)
- Cylindre nickelé pour une protection optimale contre les intempéries
- Original Diskus® design: protection à 360°
- Technique de soudage Diskus® - Résistance maximale
- Cylindre à goupilles de précision
- Fermeture obligatoire: verrouillage uniquement avec la clé (la clé ne peut pas être retirée quand le cadenas est ouvert)
- Made in Germany
- Protection pour les objets de grande valeur ou à haut risque de vol
- Idéal pour une protection contre les fortes intempéries (par exemple en mer, dans les ports, pour la protection des véhicules et des bateaux en extérieur)
- Pour la protection des camions, portes, caves, armoires et hangars

CARACTÉRISTIQUES



| Article | EAN 4003318 | | | | | | | Poids g | Unité emb. |
|-----------------|----------------|----|----|----|-----|------|----|---------|------------|
| | | mm | mm | mm | mm | mm | mm | | |
| 24IB/50 B/DFNLI | 32123 8 | 51 | 13 | 8 | 6,5 | 25,5 | 50 | 143 | 3 |
| 24IB/60 B/DFNLI | 35042 9 | 60 | 17 | 13 | 8 | 26 | 60 | 193 | 6 |
| 24IB/70 B/DFNLI | 32124 5 | 70 | 20 | 17 | 10 | 31 | 70 | 295 | 6 |

20 DISKUS®









CARACTÉRISTIQUES



DONNÉES TECHNIQUES

- Acier inoxydable - à l'intérieur et à l'extérieur
- Protection supplémentaire contre les scies
- Anse en acier cémenté spécial
- Cylindre à disque ABUS Plus: précision maximale contre les manipulations, nombre de fermetures extrêmement élevé
- Masquage des cylindres - protection maximale contre la saleté et les projections d'eau
- Technologie de soudage Diskus® - la meilleure protection contre les effractions
- Original Diskus® design: protection à 360°
- Fermeture obligatoire: verrouillage uniquement avec la clé (la clé ne peut pas être retirée quand le cadenas est ouvert)
- SZP : version avec carte de protection pour vous prémunir contre les reproductions de clés à votre insu
- Made in Germany
- Deux clés incluses
- Protection d'objets de grande valeur ou avec un risque de vol très élevé
- Pour la protection de camions, d'utilitaires, d'entrepôts d'usine, de portes de caves, etc.
- Idéal en combinaison avec morillons ABUS Diskus® 140, empêchant l'accès à l'anse avec des outils d'effraction

| Article | EAN 4003318 |  mm |  mm |  mm |  mm |  mm |  mm | Poids g | Unité emb. |
|---------------|----------------|-----------------------------------------------------------------------------------------|-----------------------------------------------------------------------------------------|-----------------------------------------------------------------------------------------|-----------------------------------------------------------------------------------------|-------------------------------------------------------------------------------------------|-------------------------------------------------------------------------------------------|---------|------------|
| 20/70 vs. | 08854 4 | 70 | 20 | 17 | 10 | 30,5 | 70 | 306 | 6 |
| 20/80 vs. | 08798 1 | 80 | 25 | 18 | 11 | 35,5 | 81 | 416 | 3 |
| 20/70 B/DFNLI | 35023 8 | 70 | 20 | 17 | 10 | 30,5 | 70 | 308 | 3 |
| 20/80 B/DFNLI | 35024 5 | 80 | 25 | 18 | 11 | 35,5 | 81 | 418 | 3 |

147TSA









TECHNOLOGIE



DONNÉES TECHNIQUES

- Corps de cadenas en plastique
- Epaisseur de l'anse 3 mm
- Code personnalisable à 3 chiffres
- Indicateur rouge visible à l'anse: le cadenas a été ouvert par TSA. Pour réinitialiser l'indicateur rouge, ouvrir le cadenas et tourner l'anse de 360°
- Protection d'objets de petite valeur ou avec un risque de vol faible
- Convient par exemple pour la sécurisation des bagages
- Idéal pour les voyages aux États-Unis: ouverture et fermeture des bagages par les douanes américaine sans risque de dommage pour le cadenas

| Article | EAN 4003318 |  mm |  mm |  mm |  mm |  mm |  mm | Poids g | Unité emb. |
|-------------|----------------|-------------------------------------------------------------------------------------------|-------------------------------------------------------------------------------------------|-------------------------------------------------------------------------------------------|-------------------------------------------------------------------------------------------|---------------------------------------------------------------------------------------------|---------------------------------------------------------------------------------------------|---------|------------|
| 147TSA/30 B | 53093 7 | 33 | 13 | 20 | 3 | 14 | 60 | 32 | 12 |

SUPPORTS D'ANTIVOLS ET SACOCHES



**SUPPORT
SH B**



black

Page 132

**SUPPORT
USKF**



black

Page 133

**SUPPORT
EAZY KFT™**



black

Page 133

**SUPPORT USH 540 /
470 / 460 / 440A**



black

Page 133

**SUPPORT
GH 50**



black

Page 134

**SUPPORT
UGH 02**



black

Page 134

SHACKLE CLAMP



black

Page 134

**SUPPORT
SADDLEFIX SH SF**



black

Page 135

**SUPPORT
SH 6500A SMARTX™**



black

Page 135

**SUPPORT
SH 6500K BORDO™**



black

Page 135

**SUPPORT
SH 6500 BORDO™ BIG**



black

Page 136

**SUPPORT
SH 6000 BORDO™**



black

Page 136

**SUPPORT
SH FL**



black

Page 136

**SUPPORT
SH 6000 BORDO™ BIG**



black

Page 137

**SUPPORT
SH 5700 BORDO™**



black

Page 137

**SUPPORT SH 5700
UGRIP BORDO™ BIG**



black

Page 137

**SUPPORT
SH 6055 BORDO™ LITE**



black

Page 138

**SUPPORT
SR 6055 BORDO™**



black

Page 138

**SUPPORT
ST 6000 BORDO™**



black

Page 138

**SUPPORT ST 6000
BORDO™ BIG**



black

Page 139

**SUPPORT ST 5700
UGRIP BORDO™**



black

Page 139

**SUPPORT
IVERA RBU**



black

Page 139

**SUPPORT
QUICK STORE QST**



black

Page 140

**SUPPORT
SADDLEFIX QST**



black

Page 140

**CHAIN BAG
ST 2012**



black

Page 140

**SAC
ST 5850 / 5650 / 4960**



black

Page 141

**SUPPORT
SNAP CAGE**



black

Page 141

**SUPPORT
SCLL**



black

Page 141

**SUPPORT SELLE ROYAL
(5C, 5K, 6C, 6K)**



black

Page 142

**SUPPORT
FIDLOCK FL**



black

Page 142

**SUPPORT
FIDLOCK TEXFL**



black

Page 142

**SUPPORT
TEXKF MINI**



black

Page 143

**SUPPORT
QUICKSNAP RBU**



black

Page 143

**SUPPORT
QUICKSNAP**



black

Page 143

**SUPPORT
KF**



black

Page 144

**SUPPORT
URB**



black

Page 144

**ADAPTATEUR
STRAP LH**



black

Page 144

**ORYDE
ST 2250**



black

Page 145

**ORYDE
ST 2200**



black

Page 145

**ORYDE
ST 2085**



black

Page 145

**ORYDE
ST 2100**



black

Page 146

**BASICO
ST 5200**



black

Page 146

ST 5950 2.0



black

Page 146

SUPPORT SH B



DONNÉES TECHNIQUES

- Support d'antivol universel pour de nombreux antivols ABUS
- Le support convient aux antivols en U à anse carrée ou ronde
- Permet le transport de l'antivol sur différents endroits du vélo
- Le support permet une fixation horizontale ou verticale au niveau du cadre
- Convient pour les antivols U 640, 540, 470, 460
- Manipulation rapide et intuitive
- Convient aux cadres de 20 à 55 mm de diamètre

| Article | 4003318 | Poids g | Support d' antivols | Unité emb. |
|--------------|---------|------------|-------------------------|---------------|
| Support SH B | 67899 8 | 150 | pour 640, 540, 470, 460 | 1 |

SUPPORT USKF



DONNÉES TECHNIQUES

- Pour le transport des antivols U
- Fixation sur tous les tubes de cadres d'un diamètre de 18 à 70 mm
- Support en plastique avec incrustations en caoutchouc pour un meilleur montage
- Manipulation à une seule main
- Montage simple et rapide

| Article | 4003318 | Poids g | Support d' antivols | Unité emb. |
|--------------|---------|------------|------------------------------------|---------------|
| Support USKF | 86143 7 | 65 | pour 64/46/47/770A/540/460/470/640 | 1 |

SUPPORT EAZY KF™



DONNÉES TECHNIQUES

- Pour le transport des antivols U
- Fixation sur tout type de cadre arrondi (diamètre de 28 à 36 mm)
- Livré avec deux sachets de vis de deux longueurs
- Fixation au dessus des colliers de serrage à l'aide de pièces réglables
- Indicateur montrant que le système est bien verrouillé
- Manipulation à une seule main
- Montage rapide et simple
- Exécution brevetée

| Article | 4003318 | Exécution | Poids g | Support d' antivols | Unité emb. |
|------------------------|---------|-----------|------------|------------------------------------------|---------------|
| Support EaZy KF™ | 45342 7 | | 95 | pour 64/61/54/51/47/640/540/470/460/770A | 1 |
| Support pour anse 11mm | 45344 1 | Ø 11 mm | 22 | pour 61/64 EaZy KF | 1 |
| Support pour anse 12mm | 45347 2 | Ø 12 mm | 24 | pour 460/470 | 1 |
| Support pour anse 13mm | 45343 4 | Ø 13 mm | 26 | pour 540/770A | 1 |
| Support pour anse 13mm | 45346 5 | Ø 13 mm | 28 | pour 51/501 | 1 |

SUPPORT USH540 / 470 / 460 / 420 / 440A TEX



DONNÉES TECHNIQUES

- Pour le transport des antivols U
- Fixation sur tous les tubes de cadres d'un diamètre de 15 à 35 mm
- Fixation sur les parties latérales du porte-bagage
- Transport possible de l'antivol sur le triangle du cadre ou le long du vélo

| Article | 4003318 | Exécution | Poids g | Support d' antivols | Unité emb. |
|-----------------------|---------|-----------|------------|---------------------|---------------|
| Support USH 540 | 18576 2 | | 150 | pour 540 | 1 |
| Support USH 460 / 470 | 18578 6 | | 120 | pour 460 / 470 | 1 |
| Support USH 440 Tex | 87553 3 | | 96 | pour 440A | 1 |

SUPPORT GH 50



DONNÉES TECHNIQUES

- Pour le transport des antivols U
- Fixation au porte-bagage
- Fixation sur les parties latérales du porte-bagage

| Article | EAN 4003318 | Exécution | Poids g | Support d' antivols | Unité emb. |
|---------------|----------------|-----------|------------|-----------------------------------|---------------|
| Support GH 50 | 00904 4 | | 196 | pour 64, 51, 47, 46, 470, 460, 32 | 1 |

SUPPORT UGH 02



DONNÉES TECHNIQUES

- Pour le transport des antivols et des Steel-0-Flex
- Fixation au porte-bagage (diamètre de tubes de 5 à 16,5 mm)
- Se fixe sur tout type de porte-bagage
- Montage simple et rapide

| Article | EAN 4003318 | Exécution | Poids g | Support d' antivols | Unité emb. |
|----------------|----------------|-----------|------------|------------------------------------------------------|---------------|
| Support UGH 02 | 26624 9 | | 80 | pour 32, 410, 440, 460, 420, 470, 640, 540, 770A, 59 | 1 |

SHACKLE CLAMP



DONNÉES TECHNIQUES

- Accessoire pour le transport des antivols U ABUS sur le support TUBUS LOCC, ou TexKF Twin ou RBKF Twin

| Article | EAN 4003318 | Exécution | Poids g | Support d' antivols | Unité emb. |
|------------------------|----------------|-----------|------------|----------------------------|---------------|
| Support pour anse 12mm | 25604 2 | Ø 12 mm | 21 | pour 46, 47, 460, 470, 640 | 1 |
| Support pour anse 13mm | 27348 3 | Ø 13 mm | 30 | für 540, 770A | 1 |

SUPPORT SH SF SADDLEFIX



DONNÉES TECHNIQUES

- Adaptateur universel pour une fixation peu encombrante de divers antivols BORDO™ aux montants de la selle
- Le BORDO™ souhaité peut être fixé sur l'adaptateur avec le support correspondant
- Une protection contre les éclaboussures et les intempéries pour le BORDO™
- Les trous de l'adaptateur sont analogues à ceux d'un porte - bidon, de sorte que celui-ci ou le SportFlex pourraient également être fixés à l'adaptateur
- Les vis sont comprises dans la livraison
- Adaptateur pour la fixation à la selle
- Convient aux supports SH 5700, 6000 et 6500
- Protection pratique contre la pluie, la saleté et l'humidité

| Article | 4003318 | Exécution | Poids g | Support d' antivols | Unité emb. |
|---------------|---------|-----------------|---------|-----------------------------------------------------------------------------------|------------|
| Support SH SF | 67866 0 | Avec protection | 121 | pour SH 5700C/80, SH 5700K/80, SH 6000C/90, SH 6000K/120, SH 6000K/90, SH 6500/85 | 3 |

SUPPORT SH 6500A SMARTX



DONNÉES TECHNIQUES

- Pour faciliter le transport du BORDO 6500A SmartX
- Montage facile par bande de serrage ou bande Velcro
- Encombrement réduit, l'antivol pouvant être retiré par l'avant
- Idéal pour les petites géométries de cadre

| Article | 4003318 | Exécution | Poids g | Support d' antivols | Unité emb. |
|--------------------------|---------|-----------|---------|---------------------|------------|
| Support SH 6500A SmartX™ | 63488 8 | | 148 | pour 6500A/110 | 1 |

SUPPORT SH 6500K BORDO™



DONNÉES TECHNIQUES

- Transport facile pour le BORDO™ 6500K et 6500KA
- Montage simple et sans outils grâce aux colliers de serrage
- Le Bordo peut être facilement retiré vers l'avant
- Parfait pour les petits cadres

| Article | 4003318 | Exécution | Poids g | Support d' antivols | Unité emb. |
|----------------------|---------|-----------|---------|--------------------------|------------|
| Support SH 6500K/90 | 69051 8 | | 195 | pour 6500KA/90, 6500K/90 | 3 |
| Support SH 6500K/120 | 96279 0 | | 230 | pour 6500K/120 | 3 |

SUPPORT SH 6500 BORDO XPLUS™



DONNÉES TECHNIQUES

- Transport facile pour le BORDO™ 6500 BIG
- Montage simple et sans outils grâce aux colliers de serrage
- Le Bordo peut être facilement retiré vers l'avant
- Parfait pour les petits cadres

| Article | 4003318 | Exécution | Poids g | Support d' antivols | Unité emb. |
|---------------------|---------|-----------|------------|---------------------|---------------|
| Support SH 6500/85 | 61557 3 | | 152 | pour 6500/85 | 3 |
| Support SH 6500/110 | 61556 6 | | 172 | pour 6500/110 | 3 |

SUPPORT SH 6000 BORDO™



DONNÉES TECHNIQUES

- Transport facile pour le BORDO 6000K, 6000KA, 6000C, 6000, 6000A et 6100
- Montage simple et sans outils grâce aux colliers de serrage
- Le Bordo peut être facilement retiré vers l'avant
- Parfait pour les petits cadres

| Article | 4003318 | Exécution | Poids g | Support d' antivols | Unité emb. |
|--------------------|---------|-----------|------------|-------------------------------------------------------------------|---------------|
| Support SH 6000/90 | 61543 6 | | 115 | pour 6000/90, 6000K/90, 6000KA/90, 6000C/90, 6000A/90, 6100/90 | 3 |

SUPPORT SHFL



DONNÉES TECHNIQUES

- Pour faciliter le transport du BORDO 6000K/90, 6000C/90 ou 6000KA/90
- Fixation magnétique facile et super rapide grâce au Fidlock TWIST bike base
- Le Bordo peut être facilement retiré vers l'avant
- Les BORDO 6000K/90 et 6000C/90 sont également disponibles séparément, sans support

| Article | 4003318 | Exécution | Poids g | Support d' antivols | Unité emb. |
|----------------------|---------|-----------|------------|-------------------------------------------------------------------|---------------|
| Support SHFL 6000/90 | 88886 1 | | 160 | pour 6000/90, 6100/90, 6000A/90, 6000K/90, 6000C/90, 6000KA/90 | 3 |

SUPPORT SH 6000 BORDO™ BIG



DONNÉES TECHNIQUES

- Transport facile pour le BORDO™ 6000 Big
- Montage simple et sans outils grâce aux colliers de serrage
- Le Bordo peut être facilement retiré vers l'avant
- Parfait pour les petits cadres

| Article | 4003318 | Exécution | Poids g | Support d' antivols | Unité emb. |
|---------------------|---------|-----------|------------|----------------------------------------------------|---------------|
| Support SH 6000/120 | 61564 1 | | 132 | pour 6000/120, 6000K/120, 6000KA/120, 6000A/120 | 3 |

SUPPORT SH 5700 BORDO



DONNÉES TECHNIQUES

- Transport facile pour le BORDO 5700K uGrip
- Montage simple et sans outils grâce aux colliers de serrage
- Le Bordo peut être facilement retiré vers l'avant
- Idéal pour les cadres de petite taille

| Article | 4003318 | Exécution | Poids g | Support d' antivols | Unité emb. |
|--------------------|---------|-----------|------------|-------------------------|---------------|
| Support SH 5700/80 | 61566 5 | | 122 | pour 5700K/80, 5700C/80 | 3 |

SUPPORT SH 5700 UGRIP BORDO BIG



DONNÉES TECHNIQUES

- Transport facile pour le BORDO 5700 uGrip BIG
- Montage simple et sans outils grâce aux colliers de serrage
- Le Bordo peut être facilement retiré vers l'avant
- Idéal pour les cadres de petite taille

| Article | 4003318 | Exécution | Poids g | Support d' antivols | Unité emb. |
|----------------------|---------|-----------|------------|---------------------|---------------|
| Support SH 5700K/100 | 61571 9 | | 122 | pour 5700/100 | 3 |

SUPPORT SH 6055 BORDO™ LITE



DONNÉES TECHNIQUES

- Transport facile pour le BORDO™ 6055 Lite
- Montage simple et sans outils grâce aux colliers de serrage
- Le Bordo peut être facilement retiré vers l'avant
- Parfait pour les petits cadres

| Article | 4003318 | Exécution | Poids g | Support d' antivols | Unité emb. |
|-----------------|---------|-----------|------------|------------------------------------------------|---------------|
| Support SH 6055 | 61572 6 | | 60 | pour 6055K/60, 6055K/85, 6055C/60, 6055C/85 | 3 |

SUPPORT SH 6055 SELLE ROYAL



DONNÉES TECHNIQUES

- Pour transporter facilement le BORDO 6055 Lite et Lite Mini (versions Key et Combo)
- Montage facile sous les selles de la marque Selle Royal
- Idéal pour une utilisation sur le vélo de route

| Article | 4003318 | Exécution | Poids g | Support d' antivols | Unité emb. |
|-----------------------------|---------|-----------|------------|------------------------------------------------|---------------|
| Support SR 6055 Selle Royal | 63151 1 | | 64 | pour 6055K/60, 6055K/85, 6055C/60, 6055C/85 | 3 |

SUPPORT ST 6000 BORDO™



DONNÉES TECHNIQUES

- Montage flexible grâce à une bandes velcro anti-glissements ou une vis au niveau du porte-bidon
- Transport facile grâce à son support pratique

| Article | 4003318 | Exécution | Poids g | Support d' antivols | Unité emb. |
|--------------------------|---------|-----------|------------|-------------------------|---------------|
| Support ST 6000/90 black | 54297 8 | | 125 | pour 6000K/90, 6000C/90 | 1 |

SUPPORT ST 6000 BORDO™ BIG



DONNÉES TECHNIQUES

- Montage flexible grâce à une bandes velcro anti-glissements ou une vis au niveau du porte-bidon
- Transport facile grâce à son support pratique

| Article | EAN 4003318 | Exécution | Poids g | Support d' antivols | Unité emb. |
|---------------------------|----------------|-----------|------------|---------------------|---------------|
| Support ST 6000/120 black | 55327 1 | | 160 | pour 6000K/120 | 1 |

SUPPORT ST 5700 UGRIP BORDO™



DONNÉES TECHNIQUES

- Sacoches avec mécanisme facile, utilisation à une seule main
- Montage flexible grâce à une bandes velcro anti-glissements ou une vis au niveau du porte-bidon
- Transport facile grâce à son support pratique

| Article | EAN 4003318 | Exécution | Poids g | Support d' antivols | Unité emb. |
|-----------------------------|----------------|-----------|------------|---------------------|---------------|
| Support ST 5700 uGrip BORDO | 11284 3 | | 103 | pour 5700K/80 | 1 |

SUPPORT IVERA RBU



DONNÉES TECHNIQUES

- Transport des antivols Ivera (chaîne, câble et Steel-0-Flex)
- Fixation à des tubes de cadres arrondis et non arrondis (diamètre de 15 à 45 mm)
- Montage facile, adaptable au support LL

| Article | EAN 4003318 | Exécution | Poids g | Support d' antivols | Unité emb. |
|-------------------|----------------|-----------|------------|-----------------------------|---------------|
| Support IVERA RBU | 58497 8 | | 125 | pour 7200, 7210, 7220 IVERA | 1 |

SUPPORT QUICKSTORE QST



DONNÉES TECHNIQUES

- Pour un transport sûr et sans claquement des antivols à chaîne sur le vélo
- Pour les antivols à chaîne ABUS d'une épaisseur de 6 mm et d'une longueur de 85 à 110 cm
- Montage facile avec des vis sur le porte-bidon ou grâce à une fixation pratique par bande de serrage
- Peut être combiné avec le support SattleFix (SF QST) pour être placé sous la selle
- Possibilité de rangement et de transport pour les antivols à chaîne

| Article | 4003318 | Exécution | Poids g | Support d' antivols | Unité emb. |
|-------------|---------|-----------|------------|---------------------|---------------|
| Support QST | 61493 4 | | 260 | pour Catena 6806K | 1 |

SUPPORT SF QST



DONNÉES TECHNIQUES

- Adaptateur pour placer un support d'antivol sous la selle
- Adapté au support QST QuickStore
- Pour transporter facilement les antivols à chaîne de 6-7 mm d'épaisseur
- Pour fixer le support QuickStore (QST) sous la selle

| Article | 4003318 | Exécution | Poids g | Support d' antivols | Unité emb. |
|----------------|---------|-----------|------------|------------------------|---------------|
| Support SF QST | 95585 3 | | 65 | Support QST Quickstore | 1 |

CHAIN BAG ST 2012



DONNÉES TECHNIQUES

- Sacoche de transport pour chaînes antivols
- Montage facile à l'aide de bandes velcro ou des vis à fixer sur le porte bidon
- Isolation du froid et de la chaleur: Epaisseur de 2 mm en néoprène
- Fixation renforcée

| Article | 4003318 | Exécution | Poids g | Support d' antivols | Unité emb. |
|-------------------|---------|----------------|------------|---------------------|---------------|
| ST 2012 Chain Bag | 58496 1 | Sacoche: 0.6 l | 188 | | 1 |

SAC ST 5850/5650/4960



DONNÉES TECHNIQUES

- Sac de transport permettant de protéger les antivols de cadres ainsi que les accessoires
- Fixation renforcée

| Article | EAN 4003318 | Exécution | Poids g | Support d' antivols | Unité emb. |
|-------------------|----------------|----------------------------------------------|------------|---------------------|---------------|
| ST 5850/5650/4960 | 48647 0 | Sacoche de transport 160 mm / 250 mm / 50 mm | 100 | | 1 |

SUPPORT SNAP CAGE



DONNÉES TECHNIQUES

- Transport de Steel-0-Flex, câble et câble spiral
- Permet le transport d'un antivol sur la tige de la selle, sur le cadre et sur le porte-bagage
- Avec un diamètre de 15 - 55 mm
- Montage simple, rapide et sans outils

| Article | EAN 4003318 | Exécution | Poids g | Support d' antivols | Unité emb. |
|----------------------------|----------------|-----------|------------|--------------------------|---------------|
| Support Snap Cage MU 6K | 20079 3 | | 40 | pour 6415K, 6512K, 6615K | 12 |
| Support Snap Cage MU 4K/5K | 20080 9 | | 40 | pour 4508K, 5510K, 5412K | 12 |
| Support Snap Cage MU 4C/5C | 20111 0 | | 40 | pour 4508C, 5412C, 5510C | 12 |
| Support Snap Cage MU 6C | 20113 4 | | 40 | pour 6415C, 6512C, 6615C | 12 |

SUPPORT SCLL



DONNÉES TECHNIQUES

- Transport pour antivols en câble, câble en spirale, et Steel-0-Flex
- Fixation sous la tige de la selle (diamètre 5-8 mm)
- Montage simple, rapide et sans outils

| Article | EAN 4003318 | Exécution | Poids g | Support d' antivols | Unité emb. |
|--------------------|----------------|-----------|------------|--------------------------|---------------|
| Support SCLL 6C | 87983 8 | | 47 | pour 6415C, 6512C, 6615C | 12 |
| Support SCLL 4K/5K | 87982 1 | | 47 | pour 4508K, 510K, 5412K | 12 |
| Support SCLL 4C/5C | 87981 4 | | 47 | pour 4508C, 5412C, 5510C | 12 |
| Support SCLL 6K | 87984 5 | | 47 | pour 6415K, 6512K, 6615K | 12 |

SUPPORT SH SELLE ROYAL



DONNÉES TECHNIQUES

- Installation et utilisation faciles et pratique
- Compatible avec Selle Royal ICS

| Article | 4003318 | Exécution | Poids g | Support d' antivols | Unité emb. |
|------------------------|---------|-----------|---------|--------------------------|------------|
| Support Selle Royal 5K | 63484 0 | | 45 | pour 4508K, 5510K, 5412K | 1 |
| Support Selle Royal 5C | 63485 7 | | 45 | pour 4508C, 5412C, 5510C | 1 |
| Support Selle Royal 6K | 63486 4 | | 45 | pour 6415K, 6512K, 6615K | 1 |
| Support Selle Royal 6C | 63487 1 | | 45 | pour 6415C, 6512C, 6615C | 1 |

SUPPORT FL



DONNÉES TECHNIQUES

- Exclusivement pour le transport du nouveau Phantom 8960, 8950 et 8940
- Pour un montage sans effort, utilisation facile du support magnétique
- Fixation sous la tige de la selle (diamètre 5-8 mm)
- Montage facile

| Article | 4003318 | Exécution | Poids g | Support d' antivols | Unité emb. |
|------------|---------|-----------|---------|-------------------------------|------------|
| Support FL | 39729 5 | | 61 | pour Phantom 8960, 8950, 8940 | 1 |

SUPPORT TEXFL



DONNÉES TECHNIQUES

- Exclusivement pour le transport du nouveau Phantom 8960, 8950 et 8940
- Pour un montage sans effort, utilisation facile du support magnétique
- Montage sur des cadres ronds de diamètre 21-80 mm
- Lanière flexible qui facilite le montage

| Article | 4003318 | Exécution | Poids g | Support d' antivols | Unité emb. |
|---------------|---------|-----------|---------|-------------------------------|------------|
| Support TexFL | 39730 1 | | 77 | pour Phantom 8960, 8950, 8940 | 1 |

SUPPORT TEXKF MINI



DONNÉES TECHNIQUES

- Pour le transport des câbles-antivols, des câbles spirals et des antivols Steel-0-Flex
- Fixation sur des tubes de cadres arrondis et non arrondis (diamètre de 21 à 80 mm)
- Fixation à l'aide de bandes de serrage
- Fixation possible sur le triangle du cadre ou sur le côté du vélo
- Montage simple et rapide

| Article | 4003318 | Exécution | Poids g | Support d' antivols | Unité emb. |
|--------------------|---------|-----------|---------|----------------------------------|------------|
| Support TexKF Mini | 23265 7 | | 70 | pour 640, 1460, 8950, 1450, 8940 | 1 |

SUPPORT QUICKSNAP RBU



DONNÉES TECHNIQUES

- Pour le transport des câbles-antivols et des Steel-0-Flex
- Fixation à des tubes de cadres arrondis et non arrondis (diamètre de 15 à 45 mm)
- Fixation grâce à des bandes de serrage
- Fixation possible au triangle de cadre ou sur le côté
- Montage simple et rapide

| Article | 4003318 | Exécution | Poids g | Support d' antivols | Unité emb. |
|-----------------------|---------|-----------|---------|---------------------|------------|
| Support QuickSnap RBU | 31487 2 | | 40 | pour 860, 870 | 6 |

SUPPORT QUICKSNAP



DONNÉES TECHNIQUES

- Pour le transport des câbles-antivols et des Steel-0-Flex
- Fixation sous la tige de la selle (diamètre de 5 à 8 mm)
- Montage facile

| Article | 4003318 | Exécution | Poids g | Support d' antivols | Unité emb. |
|-------------------|---------|-----------|---------|---------------------|------------|
| Support QuickSnap | 31488 9 | | 46 | pour 860, 870 | 1 |

SUPPORT KF



DONNÉES TECHNIQUES

- Pour le transport des câbles-antivols, des câbles-antivols spiral et des Steel-0-Flex
- Fixation sous la tige de la selle (diamètre standard de 5 à 8 mm)
- Montage simple

| Article | 4003318 | Exécution | Poids g | Support d' antivols | Unité emb. |
|------------|---------|-----------|------------|---------------------------------------------------------------------|---------------|
| Support KF | 12433 4 | | 42 | pour 896, 895, 894, 885, 875, 1350, 1355, 1340, 1440, 1450, 1460 | 6 |

SUPPORT URB



DONNÉES TECHNIQUES

- Accessoire pour le transport des antivols, adaptable au support LL
- Permet le transport des antivols à la selle ou au cadre (diamètre de 25 à 35 mm)

| Article | 4003318 | Exécution | Poids g | Support d' antivols | Unité emb. |
|-------------|---------|--------------|------------|------------------------------------|---------------|
| Support URB | 23312 8 | Ø 25 - 35 mm | 30 | pour antivols avec le support „LL“ | 12 |

ADAPTATEUR STRAP LH



DONNÉES TECHNIQUES

- Aide au montage d'antivol de cadre sur les différents tubes du vélo

| Article | 4003318 | Exécution | Poids g | Support d' antivols | Unité emb. |
|---------------------|---------|-----------|------------|----------------------------------------|---------------|
| Bande de serrage LH | 56240 2 | | 48 | pour toutes les antivols de cadre ABUS | 1 |

ORYDE ST 2250



DONNÉES TECHNIQUES

- Volume: 1,8 litres
- Matériaux résistants et imperméables 420D et Scotch Rip 58
- Forme robuste grâce à un rembourrage
- Bandes réfléchissantes
- Espace intérieur pratique avec porte-clés
- Grand espace de rangement
- Sacoche de cadre pour le quotidien et les loisirs

| Article | EAN 4003318 | Volume l | Largeur mm | Hauteur mm | Profondeur mm | Exécution | Unité emb. |
|---------|----------------|-------------|---------------|---------------|------------------|-----------------|---------------|
| ST 2250 | 08469 0 | 1,8 | 235 | 195 | 50 | Attaches Velcro | 1 |

ORYDE ST 2200



DONNÉES TECHNIQUES

- Volume: 1,2 litres
- Matériaux résistants et imperméables 420D et Scotch Rip 58
- Forme robuste grâce à un rembourrage
- Bandes réfléchissantes
- Espace intérieur pratique avec porte-clés
- Grand espace de rangement
- Sacoche de cadre pour le quotidien et les loisirs

| Article | EAN 4003318 | Volume l | Largeur mm | Hauteur mm | Profondeur mm | Exécution | Unité emb. |
|---------|----------------|-------------|---------------|---------------|------------------|-----------------|---------------|
| ST 2200 | 08470 6 | 1,2 | 255 | 100 | 50 | Attaches Velcro | 1 |

ORYDE ST 2085



DONNÉES TECHNIQUES

- Volume: 0,7 litre
- Matériaux résistants et imperméables 420D et Scotch Rip 58
- Forme solide grâce à un rembourrage en mousse expansée
- Bandes réfléchissantes
- Espace intérieur pratique avec porte-clés
- Pratique à remplir grâce au système ABUS Easy Flap
- Livrée avec une housse de pluie équipée d'un logo réfléchissant
- Sacoche de selle utilisable au quotidien, pour le sport et les loisirs

| Article | EAN 4003318 | Volume l | Largeur mm | Hauteur mm | Profondeur mm | Exécution | Unité emb. |
|------------|----------------|-------------|---------------|---------------|------------------|-----------|---------------|
| ST 2085 KF | 08479 9 | 0,7 | 75 | 70 | 145 | KLICKfix® | 1 |

ORYDE ST 2100



DONNÉES TECHNIQUES

- Volume: 1,2 litres
- Matériaux résistants et imperméables 420D et Scotch Rip 58
- Forme solide grâce à un rembourrage en mousse expansée
- Bandes réfléchissantes
- Espace intérieur pratique avec porte-clés
- Extensible: Volume supplémentaire grâce à un soufflet avec fermeture zippée
- Sacoche de selle utilisable au quotidien, pour le sport et les loisirs

| Article | EAN 4003318 | Volume l | Largeur mm | Hauteur mm | Profondeur mm | Exécution | Unité emb. |
|------------|----------------|-------------|---------------|---------------|------------------|-----------|---------------|
| ST 2100 KF | 08472 0 | 1,2 | 80 | 95 | 150 | Klickfix® | 6 |

BASICO ST 5200



DONNÉES TECHNIQUES

- Volume: 1,2 litres
- Matériaux résistants et hydrofuges
- Espace intérieur pratique
- Vaste compartiment principal
- Bandes réfléchissantes
- Sacoche de cadre pour le quotidien et les loisirs

| Article | EAN 4003318 | Volume l | Largeur mm | Hauteur mm | Profondeur mm | Exécution | Unité emb. |
|---------|----------------|-------------|---------------|---------------|------------------|-----------------|---------------|
| ST 5200 | 08482 9 | 1,2 | 255 | 110 | 65 | Attaches velcro | 1 |

ST 5950 2.0



DONNÉES TECHNIQUES

- Sacoche de selle pour le quotidien et les loisirs

| Article | EAN 4003318 | Volume l | Largeur mm | Hauteur mm | Profondeur mm | Exécution | Unité emb. |
|-------------|----------------|-------------|---------------|---------------|------------------|-----------------|---------------|
| ST 5950 2.0 | 87510 6 | 0,6 | 160 | 85 | 90 | Attaches velcro | 1 |



ABUS OEM : PREMIÈRE MONTE

UN PARTENAIRE FORT, UN FOURNISSEUR FIABLE ABUS COMME PARTENAIRE OEM - VOTRE PREMIER CHOIX



Les facteurs décisifs sur le marché du vélo sont la plus-value, la différenciation, la flexibilité, la disponibilité, un service rapide et de grandes performances. Les fournisseurs qui collaborent avec des fabricants de vélos doivent répondre aux exigences requises. ABUS correspond à ce profil.

En tant que spécialistes à l'échelle internationale dans la sécurité mobile, nous vous offrons le meilleur soutien et nous vous garantissons une fiabilité optimale.

Depuis de nombreuses années, ABUS est synonyme de sécurité et la société est devenue un précurseur sur le marché des accessoires.

La qualité « Made in Germany » avec une livraison « dans les temps » : Cet investissement dans le business „OEM“ nous a permis de devenir un partenaire important pour de nombreux fabricants de vélos dans le monde entier. Par ailleurs, nous offrons en tant que partenaire

fort du marché OEM un vaste choix d'antivol de cadres et de nombreuses solutions de sécurité. Nous fournissons entre autres des antivol avec des serrures à clé unique et des cylindres pour les batteries des vélos à assistance électrique - également disponibles en option.

Pour ces raisons : exploitons nos synergies communes afin d'emprunter le chemin du succès !

Notre équipe OEM est impatiente de vous lire.
Contact : contact@abus.fr

Nous sommes ravis de poursuivre notre bonne collaboration avec les leaders du marché du vélo !





SÉCURITÉ

Les solutions de sécurité ne sont pas seulement une tendance, elles sont aussi un moyen très confortable pour les cyclistes de mettre en sécurité leurs vélos tant appréciés. Profitez de notre expérience de plus de 90 ans et sortez du lot avec des solutions de sécurité sur-mesure.

ADVANCED

Bianchi
LIFE

BERGAMONT

BULLS

CANYON

CORRATEC

 **CUBE** *FLYER* *HAIBIHE*

HERCULES

 **Husqvarna**
E-BICYCLES

KETTLER ALU-RAD

KTM
BIKE INDUSTRIES

MCG
MERIDA & CENTURION GERMANY GMBH

ORBEA

RIESE & MÜLLER

SCOTT

SERIAL

 **SIMPLON**

 **SPECIALIZED**

STEVENS
BIKES

tern

TREK

URBAN ARROW

VELO@VILLE

zemo
zero emission mobility

ROUTE



AIRBREAKER



performance red

Page 160



goldfish orange

Page 160



polar white matt

Page 160



moss green

Page 160



Movistar Team 23

Page 160



velvet black

Page 160



race grey

Page 160



polar white shiny

Page 160



gleam silver

Page 160



flip flop

Page 160



dark grey

Page 160



black gold

Page 160

GAMECHANGER TT



shiny white

Page 162



shiny black

Page 162



blaze red

Page 162



flip flop purple

Page 162



champagne gold

Page 162

GAMECHANGER TRI



blaze red

Page 164



shiny white

Page 164



shiny black

Page 164



flip flop purple

Page 164



champagne gold

Page 164

GAMECHANGER 2.0



shiny white

Page 166



velvet black

Page 166



titan

Page 166



race grey

Page 166



performance red

Page 166



flip flop purple

Page 166



goldfish orange

Page 166



gleam silver

Page 166



moss green

Page 166



polar white

Page 166



black gold

Page 166



velvet black

Page 166



shiny white

Page 166



performance red

Page 166



flip flop purple

Page 166

STORMCHASER ACE



velvet black

Page 168



race grey

Page 168



performance red

Page 168



flip flop purple

Page 168



polar white

Page 168

POWERDOME ACE



moss green

Page 170



race grey

Page 170



metallic copper

Page 170

POWERDOME



gleam silver

Page 172



polar white

Page 172



velvet black

Page 172



shiny black

Page 172



titan

Page 172



shiny white

Page 172



goldfish orange

Page 172



blaze red

Page 172



flip flop purple

Page 172



Mips

gleam silver

Page 172



Mips

polar white

Page 172



Mips

velvet black

Page 172



Mips

shiny black

Page 172



Mips

titan

Page 172



Mips

shiny white

Page 172



Mips

goldfish orange

Page 172



Mips

blaze red

Page 172



Mips

flip flop purple

Page 172

WINGBACK



flip flop purple

Page 174



velvet black

Page 174



titan

Page 174



race grey

Page 174



shiny white

Page 174



performance red

Page 174



goldfish orange

Page 174



gleam silver

Page 174



moss green

Page 174



polar white

Page 174

MACATOR



matt titan

Page 176



white silver

Page 176



velvet black

Page 176



titan

Page 176



steel blue

Page 176



signal yellow

Page 176



shiny rose

Page 176



race grey

Page 176



pearl white

Page 176



midnight blue

Page 176



gleam silver

Page 176



blaze red

Page 176



matt black

Page 176



matt blue

Page 176



velvet black

Page 176



signal yellow

Page 176



polar white

Page 176



pearl white

Page 176



shiny black

Page 176



POWERFORMS

MADE IN ITALY

AERIAL





CARACTÉRISTIQUES PRODUITS

AIRBREAKER

GAMECHANGER 2.0

STORMCHASER ACE

POWERDOME

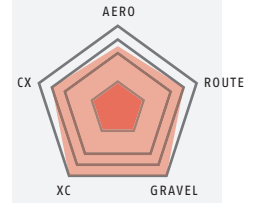
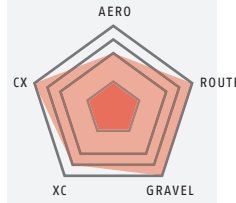
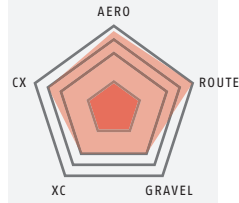
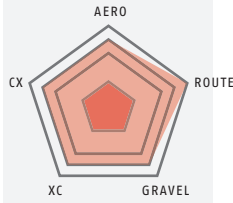

| | | | | |
|------------------|---|---|---|---|
| COQUE | 4 | 5 | 4 | 2 |
| COQUE BASSE | ✓ | ✓ | ✓ | - |
| SUPPORT LUNETTES | ✓ | ✓ | ✓ | - |
| GRILLE | ✓ | ✓ | - | - |

| | | | | |
|----------------------|------------|-----------------------|-----------------|------------|
| SYSTÈME D'AJUSTEMENT | ZOOM | ZOOM PRO | ZOOM PRO | ZOOM ACE |
| | FLOATING | FLOATING PRO | FLOATING | FLOATING |
| | FLOWSTRAPS | FLOWSTRAPS PRO | FLOWSTRAPS | FLOWSTRAPS |
| POIDS | 200g | 250g | 220g | 220g |
| TYPE DE PACKAGING | SLIDER | SLIDER | EASY | EASY |
| LIEU DE FABRICATION | ITALIE | ITALIE | ITALIE | ITALIE |
| VISIÈRE | - | - | - | - |
| COMPLÈMENTS | - | Mips DLIN | - | Mips |
| TAILLES | S/M/L | S/M/L | S/M/L | S/M/L |

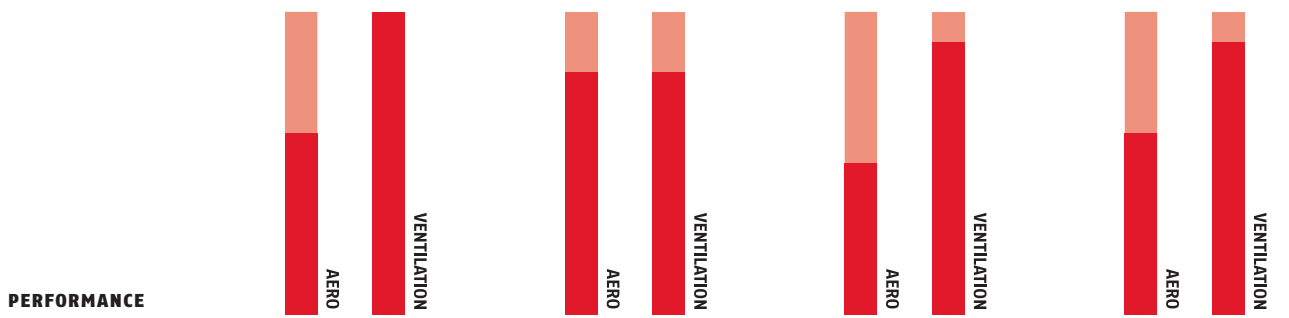

WINGBACK

MACATOR

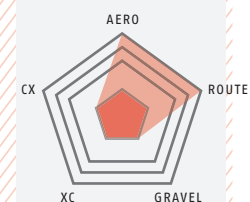
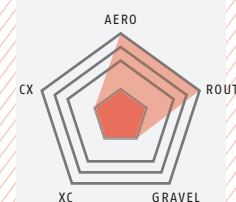
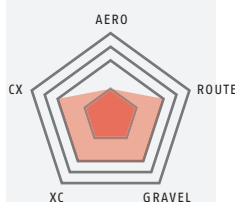
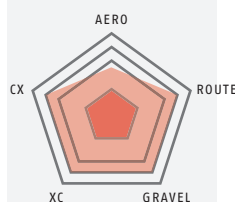
GAMECHANGER
TTGAMECHANGER
TRI

| | | | | |
|-------------------------|-----|---|---|---|
| COQUE | 1,5 | 1 | 6 | 5 |
| COQUE BASSE | - | - | ✓ | ✓ |
| SUPPORT LUNETTES | - | - | - | ✓ |
| GRILLE | - | - | - | - |

| | | | | |
|-----------------------------|------------|----------|------------|------------|
| SYSTÈME D'AJUSTEMENT | ZOOM ACE | ZOOM ACE | ZOOM | ZOOM |
| TYPES DE MOUSSE | VELCRO | VELCRO | FLOATING | FLOATING |
| TYPES DE LANIÈRES | FLOWSTRAPS | DIVIDER | FLOWSTRAPS | FLOWSTRAPS |
| POIDS | 240g | 300g | 390g | 320g |
| TYPE DE PACKAGING | EASY | SIMPLE | SLIDER | SLIDER |
| LIEU DE FABRICATION | ITALIE | CHINE | ITALIE | ITALIE |
| VISIÈRE | - | ✓ | ✓ | ✓ |
| COMPLÈMENTS | | | - | - |
| TAILLES | S/M/L | S/M/L | S/M/L | S/M/L |

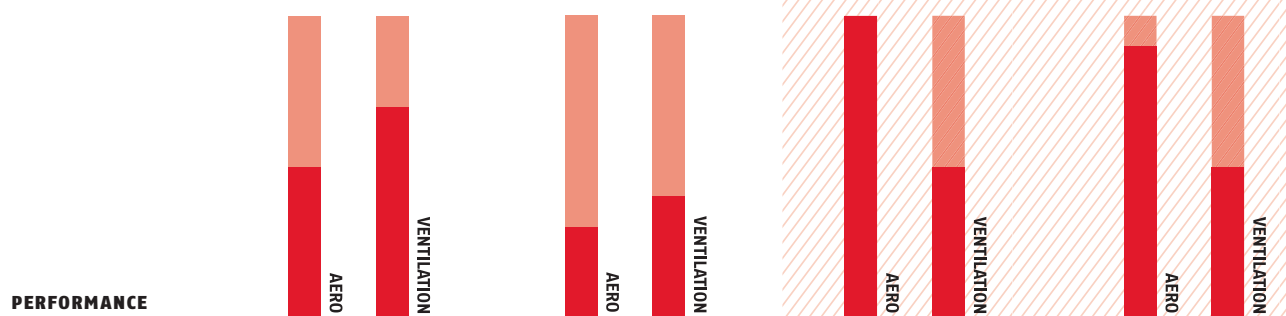

AIRBREAKER

VUES



performance red



performance red



CARACTÉRISTIQUES



Zoom Ace



Boucle



FlowStraps



Grille



Support lunettes

ACCESSOIRES

- Housse ABUS
- Housse ABUS Sportiv
- Casquette

TECHNOLOGIE



VARIANTES



goldfish orange



polar white matt



moss green



Movistar Team 23



velvet black



race grey



polar white shiny



gleam silver



flip flop



dark grey



black gold

| Article | EAN 4003318 | Couleur | Finition | Poids g | Taille | Tour de tête cm | Unité emb. |
|------------|----------------|------------------|----------|---------|--------|-----------------|---------------|
| AirBreaker | 97973 6 | performance red | shiny | 200 | S | 51 - 55 | 1 |
| AirBreaker | 97974 3 | performance red | shiny | 210 | M | 52 - 58 | 1 |
| AirBreaker | 97975 0 | performance red | shiny | 230 | L | 59 - 61 | 1 |
| AirBreaker | 97976 7 | goldfish orange | shiny | 200 | S | 51 - 55 | 1 |
| AirBreaker | 97977 4 | goldfish orange | shiny | 210 | M | 52 - 58 | 1 |
| AirBreaker | 97978 1 | goldfish orange | shiny | 230 | L | 59 - 61 | 1 |
| AirBreaker | 97980 4 | polar white | matt | 200 | S | 51 - 55 | 1 |
| AirBreaker | 97981 1 | polar white | matt | 210 | M | 52 - 58 | 1 |
| AirBreaker | 97982 8 | polar white | matt | 230 | L | 59 - 61 | 1 |
| AirBreaker | 97983 5 | moss green | shiny | 200 | S | 51 - 55 | 1 |
| AirBreaker | 97984 2 | moss green | shiny | 210 | M | 52 - 58 | 1 |
| AirBreaker | 97985 9 | moss green | shiny | 230 | L | 59 - 61 | 1 |
| AirBreaker | 97986 6 | Movistar Team 23 | shiny | 200 | S | 51 - 55 | 1 |
| AirBreaker | 97987 3 | Movistar Team 23 | shiny | 210 | M | 52 - 58 | 1 |
| AirBreaker | 97988 0 | Movistar Team 23 | shiny | 230 | L | 59 - 61 | 1 |
| AirBreaker | 81719 9 | velvet black | matt | 200 | S | 51 - 55 | 1 |
| AirBreaker | 81720 5 | velvet black | matt | 210 | M | 52 - 58 | 1 |
| AirBreaker | 81721 2 | velvet black | matt | 230 | L | 59 - 61 | 1 |
| AirBreaker | 40278 4 | race grey | shiny | 200 | S | 51 - 55 | 1 |
| AirBreaker | 40279 1 | race grey | shiny | 210 | M | 52 - 58 | 1 |
| AirBreaker | 40280 7 | race grey | shiny | 230 | L | 59 - 61 | 1 |
| AirBreaker | 81731 1 | polar white | shiny | 200 | S | 51 - 55 | 1 |
| AirBreaker | 81732 8 | polar white | shiny | 210 | M | 52 - 58 | 1 |
| AirBreaker | 81733 5 | polar white | shiny | 230 | L | 59 - 61 | 1 |
| AirBreaker | 81740 3 | gleam silver | matt | 200 | S | 51 - 55 | 1 |
| AirBreaker | 81741 0 | gleam silver | matt | 210 | M | 52 - 58 | 1 |
| AirBreaker | 81742 7 | gleam silver | matt | 230 | L | 59 - 61 | 1 |
| AirBreaker | 87512 0 | flip flop purple | shiny | 200 | S | 51 - 55 | 1 |
| AirBreaker | 87513 7 | flip flop purple | shiny | 210 | M | 52 - 58 | 1 |
| AirBreaker | 87514 4 | flip flop purple | shiny | 230 | L | 59 - 61 | 1 |
| AirBreaker | 86844 3 | dark grey | shiny | 200 | S | 51 - 55 | 1 |
| AirBreaker | 86845 0 | dark grey | shiny | 210 | M | 52 - 58 | 1 |
| AirBreaker | 86846 7 | dark grey | shiny | 230 | L | 59 - 61 | 1 |
| AirBreaker | 86829 0 | black gold | matt | 200 | S | 51 - 55 | 1 |
| AirBreaker | 86830 6 | black gold | matt | 210 | M | 52 - 58 | 1 |
| AirBreaker | 86831 3 | black gold | matt | 230 | L | 59 - 61 | 1 |



GAMECHANGER TT

VUES



shiny white



shiny white



CARACTÉRISTIQUES



Zoom Ace



Fidlock



FlowStraps



visière magnétique

ACCESSOIRES

- Housse ABUS Sportiv – Hardcover

TECHNOLOGIE



VARIANTES



shiny black



blaze red



flip flop purple



champagne gold

| Article | EAN 4003318 | Couleur | Finition | Poids g | Taille | Tour de tête cm | Unité emb. |
|----------------------------|----------------|------------------|----------|---------|--------|-----------------|---------------|
| GameChanger TT | 87885 5 | shiny black | shiny | 370 | S | 51 - 55 | 1 |
| GameChanger TT | 87886 2 | shiny black | shiny | 390 | M | 52 - 58 | 1 |
| GameChanger TT | 87887 9 | shiny black | shiny | 430 | L | 58 - 61 | 1 |
| GameChanger TT | 87888 6 | shiny white | shiny | 370 | S | 51 - 55 | 1 |
| GameChanger TT | 87889 3 | shiny white | shiny | 390 | M | 52 - 58 | 1 |
| GameChanger TT | 87890 9 | shiny white | shiny | 430 | L | 58 - 61 | 1 |
| GameChanger TT | 64177 0 | blaze red | shiny | 370 | S | 51 - 55 | 1 |
| GameChanger TT | 64178 7 | blaze red | shiny | 390 | M | 52 - 58 | 1 |
| GameChanger TT | 64180 0 | blaze red | shiny | 430 | L | 58 - 61 | 1 |
| GameChanger TT | 64182 4 | flip flop purple | shiny | 370 | S | 51 - 55 | 1 |
| GameChanger TT | 64185 5 | flip flop purple | shiny | 390 | M | 52 - 58 | 1 |
| GameChanger TT | 64186 2 | flip flop purple | shiny | 430 | L | 58 - 61 | 1 |
| GameChanger TT | 64174 9 | champagne gold | shiny | 370 | S | 51 - 55 | 1 |
| GameChanger TT | 64175 6 | champagne gold | shiny | 390 | M | 52 - 58 | 1 |
| GameChanger TT | 64176 3 | champagne gold | shiny | 430 | L | 58 - 61 | 1 |
| Visière GameChanger TT/Tri | 67936 0 | transparent | | | S | | 1 |
| Visière GameChanger TT/Tri | 67937 7 | transparent | | | M | | 1 |
| Visière GameChanger TT/Tri | 67938 4 | transparent | | | L | | 1 |
| Visière GameChanger TT/Tri | 67939 1 | fumée | | | S | | 1 |
| Visière GameChanger TT/Tri | 67940 7 | fumée | | | M | | 1 |
| Visière GameChanger TT/Tri | 67941 4 | fumée | | | L | | 1 |
| Visière GameChanger TT/Tri | 67942 1 | chrome | | | S | | 1 |
| Visière GameChanger TT/Tri | 67943 8 | chrome | | | M | | 1 |
| Visière GameChanger TT/Tri | 67944 5 | chrome | | | L | | 1 |

Route



GAMECHANGER TRI

VUES



blaze red



blaze red



CARACTÉRISTIQUES



Zoom Ace



Fidlock



FlowStraps



AirPort



visière magnétique

ACCESSOIRES

- Housse ABUS Sportiv – Hardcover

TECHNOLOGIE



VARIANTES



shiny white



shiny black



flip flop purple



champagne gold

| Article | EAN 4003318 | Couleur | Finition | Poids g | Taille | Tour de tête cm | Unité emb. |
|----------------------------|----------------|------------------|----------|---------|--------|-----------------|---------------|
| GameChanger TRI | 64275 3 | shiny white | shiny | 310 | S | 51 - 55 | 1 |
| GameChanger TRI | 64276 0 | shiny white | shiny | 320 | M | 52 - 58 | 1 |
| GameChanger TRI | 64278 4 | shiny white | shiny | 360 | L | 58 - 61 | 1 |
| GameChanger TRI | 64271 5 | shiny black | shiny | 310 | S | 51 - 55 | 1 |
| GameChanger TRI | 64272 2 | shiny black | shiny | 320 | M | 52 - 58 | 1 |
| GameChanger TRI | 64273 9 | shiny black | shiny | 360 | L | 58 - 61 | 1 |
| GameChanger TRI | 64268 5 | flip flop purple | shiny | 310 | S | 51 - 55 | 1 |
| GameChanger TRI | 64269 2 | flip flop purple | shiny | 320 | M | 52 - 58 | 1 |
| GameChanger TRI | 64270 8 | flip flop purple | shiny | 360 | L | 58 - 61 | 1 |
| GameChanger TRI | 64189 3 | champagne gold | shiny | 310 | S | 51 - 55 | 1 |
| GameChanger TRI | 64277 7 | champagne gold | shiny | 320 | M | 52 - 58 | 1 |
| GameChanger TRI | 64279 1 | champagne gold | shiny | 360 | L | 58 - 61 | 1 |
| GameChanger TRI | 64280 7 | blaze red | shiny | 310 | S | 51 - 55 | 1 |
| GameChanger TRI | 64281 4 | blaze red | shiny | 320 | M | 52 - 58 | 1 |
| GameChanger TRI | 64282 1 | blaze red | shiny | 360 | L | 58 - 61 | 1 |
| Visière GameChanger TT/Tri | 67936 0 | transparent | | | S | | 1 |
| Visière GameChanger TT/Tri | 67937 7 | transparent | | | M | | 1 |
| Visière GameChanger TT/Tri | 67938 4 | transparent | | | L | | 1 |
| Visière GameChanger TT/Tri | 67939 1 | fumée | | | S | | 1 |
| Visière GameChanger TT/Tri | 67940 7 | fumée | | | M | | 1 |
| Visière GameChanger TT/Tri | 67941 4 | fumée | | | L | | 1 |
| Visière GameChanger TT/Tri | 67942 1 | chrome | | | S | | 1 |
| Visière GameChanger TT/Tri | 67943 8 | chrome | | | M | | 1 |
| Visière GameChanger TT/Tri | 67944 5 | chrome | | | L | | 1 |

Route



GAMECHANGER 2.0

★
NEW

VUES



shiny white



shiny white



CARACTÉRISTIQUES



Zoom Pro



Support lunettes

ACCESSOIRES

- Housse ABUS Sportiv – Hardcover
- Casquette

TECHNOLOGIE



VARIANTES



velvet black



titan



race grey



performance red



flip flop purple



goldfish orange



gleam silver



moss green



polar white



black gold



MIPS

velvet black



MIPS

shiny white



MIPS

performance red



MIPS

flip flop purple

| Article | EAN 4003318 | Couleur | Finition | Poids g | Taille | Tour de tête cm | Unité emb. |
|----------------------|----------------|------------------|------------|---------|--------|-----------------|---------------|
| GameChanger 2.0 | 97996 5 | velvet black | matt+shiny | 260 | S | 51 - 55 | 1 |
| GameChanger 2.0 | 97997 2 | velvet black | matt+shiny | 265 | M | 54 - 58 | 1 |
| GameChanger 2.0 | 97998 9 | velvet black | matt+shiny | 275 | L | 57 - 61 | 1 |
| GameChanger 2.0 | 97999 6 | titan | shiny | 260 | S | 51 - 55 | 1 |
| GameChanger 2.0 | 98000 8 | titan | shiny | 265 | M | 54 - 58 | 1 |
| GameChanger 2.0 | 98001 5 | titan | shiny | 275 | L | 57 - 61 | 1 |
| GameChanger 2.0 | 98002 2 | race grey | shiny | 260 | S | 51 - 55 | 1 |
| GameChanger 2.0 | 98003 9 | race grey | shiny | 265 | M | 54 - 58 | 1 |
| GameChanger 2.0 | 98004 6 | race grey | shiny | 275 | L | 57 - 61 | 1 |
| GameChanger 2.0 | 98005 3 | shiny white | shiny | 260 | S | 51 - 55 | 1 |
| GameChanger 2.0 | 98006 0 | shiny white | shiny | 265 | M | 54 - 58 | 1 |
| GameChanger 2.0 | 98007 7 | shiny white | shiny | 275 | L | 57 - 61 | 1 |
| GameChanger 2.0 | 98008 4 | performance red | shiny | 260 | S | 51 - 55 | 1 |
| GameChanger 2.0 | 98009 1 | performance red | shiny | 265 | M | 54 - 58 | 1 |
| GameChanger 2.0 | 98010 7 | performance red | shiny | 275 | L | 57 - 61 | 1 |
| GameChanger 2.0 | 98011 4 | flip flop purple | shiny | 260 | S | 51 - 55 | 1 |
| GameChanger 2.0 | 98012 1 | flip flop purple | shiny | 265 | M | 54 - 58 | 1 |
| GameChanger 2.0 | 98013 8 | flip flop purple | shiny | 275 | L | 57 - 61 | 1 |
| GameChanger 2.0 | 98014 5 | goldfish orange | shiny | 260 | S | 51 - 55 | 1 |
| GameChanger 2.0 | 98015 2 | goldfish orange | shiny | 265 | M | 54 - 58 | 1 |
| GameChanger 2.0 | 98016 9 | goldfish orange | shiny | 275 | L | 57 - 61 | 1 |
| GameChanger 2.0 | 98017 6 | gleam silver | matt+shiny | 260 | S | 51 - 55 | 1 |
| GameChanger 2.0 | 98018 3 | gleam silver | matt+shiny | 265 | M | 54 - 58 | 1 |
| GameChanger 2.0 | 98019 0 | gleam silver | matt+shiny | 275 | L | 57 - 61 | 1 |
| GameChanger 2.0 | 98020 6 | moss green | shiny | 260 | S | 51 - 55 | 1 |
| GameChanger 2.0 | 98021 3 | moss green | shiny | 265 | M | 54 - 58 | 1 |
| GameChanger 2.0 | 98028 2 | moss green | shiny | 275 | L | 57 - 61 | 1 |
| GameChanger 2.0 | 98022 0 | polar white | matt+shiny | 260 | S | 51 - 55 | 1 |
| GameChanger 2.0 | 98023 7 | polar white | matt+shiny | 265 | M | 54 - 58 | 1 |
| GameChanger 2.0 | 98024 4 | polar white | matt+shiny | 275 | L | 57 - 61 | 1 |
| GameChanger 2.0 | 98025 1 | black gold | matt+shiny | 260 | S | 51 - 55 | 1 |
| GameChanger 2.0 | 98026 8 | black gold | matt+shiny | 265 | M | 54 - 58 | 1 |
| GameChanger 2.0 | 98027 5 | black gold | matt+shiny | 275 | L | 57 - 61 | 1 |
| GameChanger 2.0 MIPS | 98029 9 | velvet black | matt+shiny | 260 | S | 51 - 55 | 1 |
| GameChanger 2.0 MIPS | 98030 5 | velvet black | matt+shiny | 275 | M | 54 - 58 | 1 |
| GameChanger 2.0 MIPS | 98031 2 | velvet black | matt+shiny | 285 | L | 57 - 61 | 1 |
| GameChanger 2.0 MIPS | 98032 9 | shiny white | shiny | 260 | S | 51 - 55 | 1 |
| GameChanger 2.0 MIPS | 98033 6 | shiny white | shiny | 275 | M | 54 - 58 | 1 |
| GameChanger 2.0 MIPS | 98034 3 | shiny white | shiny | 285 | L | 57 - 61 | 1 |
| GameChanger 2.0 MIPS | 98035 0 | performance red | shiny | 260 | S | 51 - 55 | 1 |
| GameChanger 2.0 MIPS | 98036 7 | performance red | shiny | 275 | M | 54 - 58 | 1 |
| GameChanger 2.0 MIPS | 98037 4 | performance red | shiny | 285 | L | 57 - 61 | 1 |
| GameChanger 2.0 MIPS | 98038 1 | flip flop purple | shiny | 260 | S | 51 - 55 | 1 |
| GameChanger 2.0 MIPS | 98039 8 | flip flop purple | shiny | 275 | M | 54 - 58 | 1 |
| GameChanger 2.0 MIPS | 98040 4 | flip flop purple | shiny | 285 | L | 57 - 61 | 1 |



STORMCHASER ACE

VUES



velvet black



velvet black



CARACTÉRISTIQUES



Zoom Ace



FlowStraps



EyewearPort

ACCESSOIRES

- Housse ABUS
- Housse ABUS Sportiv
- Casquette

TECHNOLOGIE



VARIANTES



race grey



performance red



flip flop purple



polar white

| Article | EAN 4003318 | Couleur | Finition | Poids g | Taille | Tour de tête cm | Unité emb. |
|-----------------|----------------|------------------|----------|---------|--------|-----------------|---------------|
| StormChaser ACE | 98041 1 | velvet black | matt | 200 | S | 51 - 55 | 1 |
| StormChaser ACE | 98042 8 | velvet black | matt | 220 | M | 54 - 58 | 1 |
| StormChaser ACE | 98043 5 | velvet black | matt | 240 | L | 57 - 61 | 1 |
| StormChaser ACE | 98044 2 | race grey | shiny | 200 | S | 51 - 55 | 1 |
| StormChaser ACE | 98045 9 | race grey | shiny | 220 | M | 54 - 58 | 1 |
| StormChaser ACE | 98046 6 | race grey | shiny | 240 | L | 57 - 61 | 1 |
| StormChaser ACE | 98047 3 | performance red | shiny | 200 | S | 51 - 55 | 1 |
| StormChaser ACE | 98048 0 | performance red | shiny | 220 | M | 54 - 58 | 1 |
| StormChaser ACE | 98049 7 | performance red | shiny | 240 | L | 57 - 61 | 1 |
| StormChaser ACE | 98050 3 | flip flop purple | shiny | 200 | S | 51 - 55 | 1 |
| StormChaser ACE | 98051 0 | flip flop purple | shiny | 220 | M | 54 - 58 | 1 |
| StormChaser ACE | 98052 7 | flip flop purple | shiny | 240 | L | 57 - 61 | 1 |
| StormChaser ACE | 98053 4 | polar white | matt | 200 | S | 51 - 55 | 1 |
| StormChaser ACE | 98054 1 | polar white | matt | 220 | M | 54 - 58 | 1 |
| StormChaser ACE | 98055 8 | polar white | matt | 240 | L | 57 - 61 | 1 |

Route



POWERDOME ACE

VUES



moss green



moss green



CARACTÉRISTIQUES



Zoom Ace



FlowStraps

ACCESSOIRES

- Housse ABUS
- Casquette

TECHNOLOGIE



VARIANTES



race grey



metallic copper

| Article | EAN 4003318 | Couleur | Finition | Poids g | Taille | Tour de tête cm | Unité emb. |
|---------------|----------------|-----------------|----------|---------|--------|-----------------|---------------|
| PowerDome ACE | 91970 1 | race grey | shiny | 210 | S | 51 - 55 | 1 |
| PowerDome ACE | 91971 8 | race grey | shiny | 230 | M | 54 - 58 | 1 |
| PowerDome ACE | 91972 5 | race grey | shiny | 250 | L | 57 - 61 | 1 |
| PowerDome ACE | 91976 3 | metallic copper | matt | 210 | S | 51 - 55 | 1 |
| PowerDome ACE | 91977 0 | metallic copper | matt | 230 | M | 54 - 58 | 1 |
| PowerDome ACE | 91978 7 | metallic copper | matt | 250 | L | 57 - 61 | 1 |
| PowerDome ACE | 91973 2 | moss green | shiny | 210 | S | 51 - 55 | 1 |
| PowerDome ACE | 91974 9 | moss green | shiny | 230 | M | 54 - 58 | 1 |
| PowerDome ACE | 91975 6 | moss green | shiny | 250 | L | 57 - 61 | 1 |

Route



POWERDOME

NEW

VUES



gleam silver



gleam silver



CARACTÉRISTIQUES



Zoom Ace



FlowStraps

ACCESSOIRES

- Housse ABUS
- Casquette

TECHNOLOGIE



VARIANTES



| Article | EAN 4003318 | Couleur | Finition | Poids g | Taille | Tour de tête cm | Unité emb. |
|----------------|----------------|------------------|------------|---------|--------|-----------------|---------------|
| PowerDome | 98243 9 | polar white | matt+shiny | 210 | S | 51 - 55 | 1 |
| PowerDome | 98244 6 | polar white | matt+shiny | 230 | M | 54 - 58 | 1 |
| PowerDome | 98246 0 | polar white | matt+shiny | 250 | L | 54 - 58 | 1 |
| PowerDome | 97989 7 | gleam silver | matt+shiny | 210 | S | 51 - 55 | 1 |
| PowerDome | 97990 3 | gleam silver | matt+shiny | 230 | M | 54 - 58 | 1 |
| PowerDome | 97991 0 | gleam silver | matt+shiny | 250 | L | 57 - 61 | 1 |
| PowerDome | 91920 6 | velvet black | matt+shiny | 210 | S | 51 - 55 | 1 |
| PowerDome | 91921 3 | velvet black | matt+shiny | 230 | M | 54 - 58 | 1 |
| PowerDome | 91922 0 | velvet black | matt+shiny | 250 | L | 57 - 61 | 1 |
| PowerDome | 91923 7 | shiny black | shiny | 210 | S | 51 - 55 | 1 |
| PowerDome | 91924 4 | shiny black | shiny | 230 | M | 54 - 58 | 1 |
| PowerDome | 91925 1 | shiny black | shiny | 250 | L | 57 - 61 | 1 |
| PowerDome | 91926 8 | titan | shiny | 210 | S | 51 - 55 | 1 |
| PowerDome | 91927 5 | titan | shiny | 230 | M | 54 - 58 | 1 |
| PowerDome | 91928 2 | titan | shiny | 250 | L | 57 - 61 | 1 |
| PowerDome | 91929 9 | shiny white | shiny | 210 | S | 51 - 55 | 1 |
| PowerDome | 91930 5 | shiny white | shiny | 230 | M | 54 - 58 | 1 |
| PowerDome | 91934 3 | shiny white | shiny | 250 | L | 57 - 61 | 1 |
| PowerDome | 91940 4 | goldfish orange | shiny | 210 | S | 51 - 55 | 1 |
| PowerDome | 91941 1 | goldfish orange | shiny | 230 | M | 54 - 58 | 1 |
| PowerDome | 91942 8 | goldfish orange | shiny | 250 | L | 57 - 61 | 1 |
| PowerDome | 91943 5 | blaze red | shiny | 210 | S | 51 - 55 | 1 |
| PowerDome | 91944 2 | blaze red | shiny | 230 | M | 54 - 58 | 1 |
| PowerDome | 91945 9 | blaze red | shiny | 250 | L | 57 - 61 | 1 |
| PowerDome | 91946 6 | flip flop purple | shiny | 210 | S | 51 - 55 | 1 |
| PowerDome | 91947 3 | flip flop purple | shiny | 230 | M | 54 - 58 | 1 |
| PowerDome | 91948 0 | flip flop purple | shiny | 250 | L | 57 - 61 | 1 |
| PowerDome MIPS | 97992 7 | gleam silver | matt+shiny | 240 | S | 51 - 55 | 1 |
| PowerDome MIPS | 97993 4 | gleam silver | matt+shiny | 260 | M | 54 - 58 | 1 |
| PowerDome MIPS | 97994 1 | gleam silver | matt+shiny | 280 | L | 57 - 61 | 1 |
| PowerDome MIPS | 98248 4 | polar white | matt+shiny | 240 | S | 51 - 55 | 1 |
| PowerDome MIPS | 98249 1 | polar white | matt+shiny | 260 | M | 51 - 55 | 1 |
| PowerDome MIPS | 98250 7 | polar white | matt+shiny | 280 | L | 51 - 55 | 1 |
| PowerDome MIPS | 91949 7 | velvet black | matt+shiny | 240 | S | 51 - 55 | 1 |
| PowerDome MIPS | 91950 3 | velvet black | matt+shiny | 260 | M | 54 - 58 | 1 |
| PowerDome MIPS | 91951 0 | velvet black | matt+shiny | 280 | L | 57 - 61 | 1 |
| PowerDome MIPS | 91952 7 | shiny black | shiny | 240 | S | 51 - 55 | 1 |
| PowerDome MIPS | 91953 4 | shiny black | shiny | 260 | M | 54 - 58 | 1 |
| PowerDome MIPS | 91954 1 | shiny black | shiny | 280 | L | 57 - 61 | 1 |
| PowerDome MIPS | 91955 8 | titan | shiny | 240 | S | 51 - 55 | 1 |
| PowerDome MIPS | 91956 5 | titan | shiny | 260 | M | 54 - 58 | 1 |
| PowerDome MIPS | 91957 2 | titan | shiny | 280 | L | 57 - 61 | 1 |
| PowerDome MIPS | 91958 9 | shiny white | shiny | 240 | S | 51 - 55 | 1 |
| PowerDome MIPS | 91959 6 | shiny white | shiny | 260 | M | 54 - 58 | 1 |
| PowerDome MIPS | 91960 2 | shiny white | shiny | 280 | L | 57 - 61 | 1 |
| PowerDome MIPS | 91961 9 | goldfish orange | shiny | 240 | S | 51 - 55 | 1 |
| PowerDome MIPS | 91962 6 | goldfish orange | shiny | 260 | M | 54 - 58 | 1 |
| PowerDome MIPS | 91963 3 | goldfish orange | shiny | 280 | L | 57 - 61 | 1 |
| PowerDome MIPS | 91964 0 | blaze red | shiny | 240 | S | 51 - 55 | 1 |
| PowerDome MIPS | 91965 7 | blaze red | shiny | 260 | M | 54 - 58 | 1 |
| PowerDome MIPS | 91966 4 | blaze red | shiny | 280 | L | 57 - 61 | 1 |
| PowerDome MIPS | 91967 1 | flip flop purple | shiny | 240 | S | 51 - 55 | 1 |
| PowerDome MIPS | 91968 8 | flip flop purple | shiny | 260 | M | 54 - 58 | 1 |
| PowerDome MIPS | 91969 5 | flip flop purple | shiny | 280 | L | 57 - 61 | 1 |



WINGBACK

VUES



flip flop purple



flip flop purple



CARACTÉRISTIQUES



Zoom Ace



FlowStraps

TECHNOLOGIE



VARIANTES



velvet black



titan



race grey



shiny white



performance red



goldfish orange



gleam silver



moss green



polar white

| Article | EAN 4003318 | Couleur | Finition | Poids g | Taille | Tour de tête cm | Unité emb. |
|----------|----------------|------------------|----------|---------|--------|-----------------|---------------|
| WingBack | 98056 5 | velvet black | matt | 220 | S | 51 - 55 | 1 |
| WingBack | 98057 2 | velvet black | matt | 240 | M | 54 - 58 | 1 |
| WingBack | 98058 9 | velvet black | matt | 260 | L | 57 - 61 | 1 |
| WingBack | 98059 6 | titan | shiny | 220 | S | 51 - 55 | 1 |
| WingBack | 98060 2 | titan | shiny | 240 | M | 54 - 58 | 1 |
| WingBack | 98061 9 | titan | shiny | 260 | L | 57 - 61 | 1 |
| WingBack | 98062 6 | race grey | shiny | 220 | S | 51 - 55 | 1 |
| WingBack | 98063 3 | race grey | shiny | 240 | M | 54 - 58 | 1 |
| WingBack | 98064 0 | race grey | shiny | 260 | L | 57 - 61 | 1 |
| WingBack | 98065 7 | shiny white | shiny | 220 | S | 51 - 55 | 1 |
| WingBack | 98066 4 | shiny white | shiny | 240 | M | 54 - 58 | 1 |
| WingBack | 98067 1 | shiny white | shiny | 260 | L | 57 - 61 | 1 |
| WingBack | 98068 8 | performance red | shiny | 220 | S | 51 - 55 | 1 |
| WingBack | 98069 5 | performance red | shiny | 240 | M | 54 - 58 | 1 |
| WingBack | 98070 1 | performance red | shiny | 260 | L | 57 - 61 | 1 |
| WingBack | 98071 8 | flip flop purple | shiny | 220 | S | 51 - 55 | 1 |
| WingBack | 98072 5 | flip flop purple | shiny | 240 | M | 54 - 58 | 1 |
| WingBack | 98073 2 | flip flop purple | shiny | 260 | L | 57 - 61 | 1 |
| WingBack | 98074 9 | goldfish orange | shiny | 220 | S | 51 - 55 | 1 |
| WingBack | 98075 6 | goldfish orange | shiny | 240 | M | 54 - 58 | 1 |
| WingBack | 98076 3 | goldfish orange | shiny | 260 | L | 57 - 61 | 1 |
| WingBack | 98077 0 | gleam silver | shiny | 220 | S | 51 - 55 | 1 |
| WingBack | 98078 7 | gleam silver | shiny | 240 | M | 54 - 58 | 1 |
| WingBack | 98079 4 | gleam silver | shiny | 260 | L | 57 - 61 | 1 |
| WingBack | 98080 0 | moss green | shiny | 220 | S | 51 - 55 | 1 |
| WingBack | 98081 7 | moss green | shiny | 240 | M | 54 - 58 | 1 |
| WingBack | 98082 4 | moss green | shiny | 260 | L | 57 - 61 | 1 |
| WingBack | 98083 1 | polar white | matt | 220 | S | 51 - 55 | 1 |
| WingBack | 98084 8 | polar white | matt | 240 | M | 54 - 58 | 1 |
| WingBack | 98085 5 | polar white | matt | 260 | L | 57 - 61 | 1 |

Route



MACATOR

VUES



matt titan



matt titan



CARACTÉRISTIQUES



Zoom Ace



Boucle

ACCESSOIRES

- Housse ABUS
- Casquette

TECHNOLOGIE



VARIANTES



white silver

velvet black

titan

steel blue

signal yellow

shiny rose

race grey



pearl white

midnight blue

gleam silver

blaze red

matt black

matt blue

Mips velvet black



Mips

signal yellow

Mips

polar white

Mips

pearl white

Mips

shiny black

| Article | EAN 4003318 | Couleur | Finition | Poids g | Taille | Tour de tête cm | Unité emb. |
|--------------|----------------|---------------|----------|---------|--------|-----------------|---------------|
| Macator | 87232 7 | white silver | shiny | 280 | S | 51 - 55 | 1 |
| Macator | 87233 4 | white silver | shiny | 300 | M | 52 - 58 | 1 |
| Macator | 87234 1 | white silver | shiny | 360 | L | 58 - 62 | 1 |
| Macator | 87214 3 | velvet black | shiny | 280 | S | 51 - 55 | 1 |
| Macator | 87212 9 | velvet black | shiny | 300 | M | 52 - 58 | 1 |
| Macator | 87213 6 | velvet black | shiny | 360 | L | 58 - 62 | 1 |
| Macator | 87215 0 | titan | shiny | 280 | S | 51 - 55 | 1 |
| Macator | 87216 7 | titan | shiny | 300 | M | 52 - 58 | 1 |
| Macator | 87217 4 | titan | shiny | 360 | L | 58 - 62 | 1 |
| Macator | 87242 6 | steel blue | shiny | 280 | S | 51 - 55 | 1 |
| Macator | 87243 3 | steel blue | shiny | 300 | M | 52 - 58 | 1 |
| Macator | 87244 0 | steel blue | shiny | 360 | L | 58 - 62 | 1 |
| Macator | 87229 7 | signal yellow | shiny | 280 | S | 51 - 55 | 1 |
| Macator | 87230 3 | signal yellow | shiny | 300 | M | 52 - 58 | 1 |
| Macator | 87231 0 | signal yellow | shiny | 360 | L | 58 - 62 | 1 |
| Macator | 67334 4 | shiny rose | shiny | 280 | S | 51 - 55 | 1 |
| Macator | 67335 1 | shiny rose | shiny | 300 | M | 52 - 58 | 1 |
| Macator | 67336 8 | shiny rose | shiny | 360 | L | 58 - 62 | 1 |
| Macator | 67328 3 | race grey | shiny | 280 | S | 51 - 55 | 1 |
| Macator | 67329 0 | race grey | shiny | 300 | M | 52 - 58 | 1 |
| Macator | 67330 6 | race grey | shiny | 360 | L | 58 - 62 | 1 |
| Macator | 67331 3 | pearl white | shiny | 280 | S | 51 - 55 | 1 |
| Macator | 67332 0 | pearl white | shiny | 300 | M | 52 - 58 | 1 |
| Macator | 67333 7 | pearl white | shiny | 360 | L | 58 - 62 | 1 |
| Macator | 67325 2 | midnight blue | shiny | 280 | S | 51 - 55 | 1 |
| Macator | 67326 9 | midnight blue | shiny | 300 | M | 52 - 58 | 1 |
| Macator | 67327 6 | midnight blue | shiny | 360 | L | 58 - 62 | 1 |
| Macator | 87218 1 | gleam silver | shiny | 280 | S | 51 - 55 | 1 |
| Macator | 87219 8 | gleam silver | shiny | 300 | M | 52 - 58 | 1 |
| Macator | 87220 4 | gleam silver | shiny | 360 | L | 58 - 62 | 1 |
| Macator | 87221 1 | blaze red | shiny | 280 | S | 51 - 55 | 1 |
| Macator | 87222 8 | blaze red | shiny | 300 | M | 52 - 58 | 1 |
| Macator | 87223 5 | blaze red | shiny | 360 | L | 58 - 62 | 1 |
| Macator | 91183 5 | matt black | matt | 280 | S | 51 - 55 | 1 |
| Macator | 91184 2 | matt black | matt | 300 | M | 52 - 58 | 1 |
| Macator | 91185 9 | matt black | matt | 360 | L | 58 - 62 | 1 |
| Macator | 95591 4 | matt blue | matt | 280 | S | 51 - 55 | 1 |
| Macator | 95592 1 | matt blue | matt | 270 | M | 52 - 58 | 1 |
| Macator | 95593 8 | matt blue | matt | 360 | L | 58 - 62 | 1 |
| Macator | 95588 4 | matt titan | matt | 280 | S | 51 - 55 | 1 |
| Macator | 95589 1 | matt titan | matt | 270 | M | 52 - 58 | 1 |
| Macator | 95590 7 | matt titan | matt | 360 | L | 58 - 62 | 1 |
| Macator MIPS | 89217 2 | velvet black | matt | 370 | L | 58 - 62 | 1 |
| Macator MIPS | 89218 9 | velvet black | matt | 320 | M | 52 - 58 | 1 |
| Macator MIPS | 89219 6 | velvet black | matt | 290 | S | 51 - 55 | 1 |
| Macator MIPS | 89220 2 | signal yellow | shiny | 370 | L | 58 - 62 | 1 |
| Macator MIPS | 89221 9 | signal yellow | shiny | 320 | M | 52 - 58 | 1 |
| Macator MIPS | 89222 6 | signal yellow | shiny | 290 | S | 51 - 55 | 1 |
| Macator MIPS | 89223 3 | polar white | matt | 370 | L | 58 - 62 | 1 |
| Macator MIPS | 89224 0 | polar white | matt | 320 | M | 52 - 58 | 1 |
| Macator MIPS | 89225 7 | polar white | matt | 290 | S | 51 - 55 | 1 |
| Macator MIPS | 96146 5 | pearl white | shiny | 270 | S | 51 - 55 | 1 |
| Macator MIPS | 96147 2 | pearl white | shiny | 290 | M | 52 - 58 | 1 |
| Macator MIPS | 96148 9 | pearl white | shiny | 310 | L | 58 - 62 | 1 |
| Macator MIPS | 96149 6 | shiny black | shiny | 270 | S | 51 - 55 | 1 |
| Macator MIPS | 96150 2 | shiny black | shiny | 290 | M | 52 - 58 | 1 |
| Macator MIPS | 96151 9 | shiny black | shiny | 310 | L | 58 - 62 | 1 |

VTT



AIRDROP

| | | | | |
|-----------------------------------------------------------------------------------|-----------------------------------------------------------------------------------|-----------------------------------------------------------------------------------|------------------------------------------------------------------------------------|-------------------------------------------------------------------------------------|
|  |  |  |  |  |
| Mips | Mips | Mips | Mips | Mips |
| concrete grey | black gold | polar white | velvet black | velvet black |
| Page 182 | Page 182 | Page 182 | Page 182 | Page 182 |

HIDROP

| | | | |
|-----------------------------------------------------------------------------------|-----------------------------------------------------------------------------------|-----------------------------------------------------------------------------------|------------------------------------------------------------------------------------|
|  |  |  |  |
| ★ | ★ | ★ | ★ |
| midnight blue | shiny black | shiny white | moss green |
| Page 184 | Page 184 | Page 184 | Page 184 |

CLIFFHANGER

| | | | | | |
|-----------------------------------------------------------------------------------|-----------------------------------------------------------------------------------|-----------------------------------------------------------------------------------|------------------------------------------------------------------------------------|-------------------------------------------------------------------------------------|-------------------------------------------------------------------------------------|
|  |  |  |  |  |  |
| Ti silver | concrete grey | iced mint | midnight blue | pine green | shiny white |
| Page 186 | Page 186 | Page 186 | Page 186 | Page 186 | Page 186 |

| | | | | | |
|-------------------------------------------------------------------------------------|-------------------------------------------------------------------------------------|-------------------------------------------------------------------------------------|--------------------------------------------------------------------------------------|---------------------------------------------------------------------------------------|---------------------------------------------------------------------------------------|
|  |  |  |  |  |  |
| velvet black | chalk grey | wildberry red | metallic copper | pine green | shiny white |
| Page 186 | Page 186 | Page 186 | Page 186 | Page 186 | Page 186 |

| | | | | |
|-------------------------------------------------------------------------------------|-------------------------------------------------------------------------------------|-------------------------------------------------------------------------------------|--------------------------------------------------------------------------------------|---------------------------------------------------------------------------------------|
|  |  |  |  |  |
| Mips | Mips | Mips | Mips | Mips |
| iced mint | concrete grey | velvet black | velvet black | shiny white |
| Page 186 | Page 186 | Page 186 | Page 186 | Page 186 |

MOVENTOR 2.0



wildberry red

Page 188



concrete grey

Page 188



iced mint

Page 188



midnight blue

Page 188



pine green

Page 188



shiny white

Page 188



velvet black

Page 188



chalk grey

Page 188



Ti silver

Page 188



metallic copper

Page 188



velvet black

Page 188



concrete grey

Page 188



iced mint

Page 188



pine green

Page 188



shiny white

Page 188



shiny white

Page 188



velvet black

Page 188

MODROP



chalk grey

Page 190



pine green

Page 190



velvet black

Page 190



concrete grey

Page 190



midnight blue

Page 190



iced mint

Page 190



polar white

Page 190



wildberry red

Page 190



Ti silver

Page 190



velvet black

Page 190



concrete grey

Page 190



metallic copper

Page 190



shiny white

Page 190



pine green

Page 190



iced mint

Page 190



polar white

Page 190



velvet black

Page 190



MOTRIP

shiny white

Page 192

shiny black

Page 192

midnight blue

Page 192

concrete grey

Page 192

Mips

shiny black

Page 192

Mips

shiny white

Page 192



BUTEO

polar white

Page 194

infra red

Page 194

neon yellow

Page 194

velvet black

Page 194

AIRDROP

VUES



concrete grey



concrete grey



ACCESSOIRES

- Capteur Quin
- Masque Buteo

CARACTÉRISTIQUES



Zoom Ace FF



Visière amovible réglable en hauteur



Boucle double D



Protection des clavicules



Canal de son ambiant

TECHNOLOGIE



VARIANTES



black gold



polar white



velvet black



velvet black

| Article | EAN 4003318 | Couleur | Finition | Poids g | Taille | Tour de tête cm | Unité emb. |
|-------------------|----------------|---------------|----------|---------|--------|-----------------|---------------|
| AirDrop MIPS | 66254 6 | black gold | matt | 790 | S/M | 52 - 58 | 1 |
| AirDrop MIPS | 66255 3 | black gold | matt | 890 | L/XL | 58 - 62 | 1 |
| AirDrop MIPS | 66024 5 | concrete grey | matt | 790 | S/M | 52 - 58 | 1 |
| AirDrop MIPS | 66026 9 | concrete grey | matt | 890 | L/XL | 58 - 62 | 1 |
| AirDrop MIPS | 66022 1 | polar white | matt | 790 | S/M | 52 - 58 | 1 |
| AirDrop MIPS | 66023 8 | polar white | matt | 890 | L/XL | 58 - 62 | 1 |
| AirDrop MIPS | 65800 6 | velvet black | matt | 790 | S/M | 52 - 58 | 1 |
| AirDrop MIPS | 66021 4 | velvet black | matt | 890 | L/XL | 58 - 62 | 1 |
| AirDrop MIPS QUIN | 66287 4 | velvet black | matt | 795 | S/M | 52 - 58 | 1 |
| AirDrop MIPS QUIN | 66288 1 | velvet black | matt | 895 | L/XL | 58 - 62 | 1 |
| Capteur Quin | 68838 6 | | | | | | 1 |



HIDROP

VUES



midnight blue



midnight blue



CARACTÉRISTIQUES



Boucle double D



Visière amovible
réglable en hauteur

ACCESSOIRES

- Masque Buteo

TECHNOLOGIE



VARIANTES



shiny black



shiny white



moss green

| Article | EAN 4003318 | Couleur | Finition | Poids g | Taille | Tour de tête cm | Unité emb. |
|---------|----------------|---------------|----------|---------|--------|-----------------|---------------|
| HiDrop | 98091 6 | shiny black | shiny | 1090 | S | 55 - 56 | 1 |
| HiDrop | 98092 3 | shiny black | shiny | 1070 | M | 57 - 58 | 1 |
| HiDrop | 98093 0 | shiny black | shiny | 1050 | L | 59 - 60 | 1 |
| HiDrop | 98094 7 | shiny black | shiny | 1040 | XL | 61 - 62 | 1 |
| HiDrop | 98095 4 | shiny white | shiny | 1090 | S | 55 - 56 | 1 |
| HiDrop | 98096 1 | shiny white | shiny | 1070 | M | 57 - 58 | 1 |
| HiDrop | 98097 8 | shiny white | shiny | 1050 | L | 59 - 60 | 1 |
| HiDrop | 98098 5 | shiny white | shiny | 1040 | XL | 61 - 62 | 1 |
| HiDrop | 98099 2 | moss green | shiny | 1090 | S | 55 - 56 | 1 |
| HiDrop | 98100 5 | moss green | shiny | 1070 | M | 57 - 58 | 1 |
| HiDrop | 98101 2 | moss green | shiny | 1050 | L | 59 - 60 | 1 |
| HiDrop | 98102 9 | moss green | shiny | 1040 | XL | 61 - 62 | 1 |
| HiDrop | 98103 6 | midnight blue | shiny | 1090 | S | 55 - 56 | 1 |
| HiDrop | 98104 3 | midnight blue | shiny | 1070 | M | 57 - 58 | 1 |
| HiDrop | 98105 0 | midnight blue | shiny | 1050 | L | 59 - 60 | 1 |
| HiDrop | 98106 7 | midnight blue | shiny | 1040 | XL | 61 - 62 | 1 |

VTT



CLIFFHANGER

VUES



Ti silver



Ti silver



CARACTÉRISTIQUES



Zoom Ace MTB



Fidlock



TriVider



GoggFit



Visière réglable en hauteur

ACCESSOIRES

- Capteur Quin Slim

TECHNOLOGIE



VARIANTES



concrete grey



iced mint



midnight blue matt



pine green



shiny white



velvet black



chalk grey



wildberry red



Mips

metallic copper



Mips

pine green



Mips

shiny white



Mips

iced mint



Mips

concrete grey



Mips

velvet black



Mips

velvet black



Mips

shiny white

| Article | EAN 4003318 | Couleur | Finition | Poids g | Taille | Tour de tête cm | Unité emb. |
|-------------------|----------------|-----------------|----------|---------|--------|-----------------|---------------|
| CliffHanger | 65539 5 | concrete grey | matt | 300 | S | 51 - 55 | 1 |
| CliffHanger | 65540 1 | concrete grey | matt | 325 | M | 54 - 58 | 1 |
| CliffHanger | 65541 8 | concrete grey | matt | 365 | L | 57 - 61 | 1 |
| CliffHanger | 65537 1 | iced mint | shiny | 300 | S | 51 - 55 | 1 |
| CliffHanger | 65538 8 | iced mint | shiny | 325 | M | 54 - 58 | 1 |
| CliffHanger | 66695 7 | iced mint | shiny | 365 | L | 57 - 61 | 1 |
| CliffHanger | 65531 9 | midnight blue | matt | 300 | S | 51 - 55 | 1 |
| CliffHanger | 65532 6 | midnight blue | matt | 325 | M | 54 - 58 | 1 |
| CliffHanger | 65533 3 | midnight blue | matt | 365 | L | 57 - 61 | 1 |
| CliffHanger | 65534 0 | pine green | matt | 300 | S | 51 - 55 | 1 |
| CliffHanger | 65535 7 | pine green | matt | 325 | M | 54 - 58 | 1 |
| CliffHanger | 65536 4 | pine green | matt | 365 | L | 57 - 61 | 1 |
| CliffHanger | 65528 9 | shiny white | shiny | 300 | S | 51 - 55 | 1 |
| CliffHanger | 65529 6 | shiny white | shiny | 325 | M | 54 - 58 | 1 |
| CliffHanger | 65530 2 | shiny white | shiny | 365 | L | 57 - 61 | 1 |
| CliffHanger | 65525 8 | velvet black | matt | 300 | S | 51 - 55 | 1 |
| CliffHanger | 65526 5 | velvet black | matt | 325 | M | 54 - 58 | 1 |
| CliffHanger | 65527 2 | velvet black | matt | 365 | L | 57 - 61 | 1 |
| CliffHanger | 67242 2 | Ti silver | matt | 300 | S | 51 - 55 | 1 |
| CliffHanger | 67243 9 | Ti silver | matt | 325 | M | 54 - 58 | 1 |
| CliffHanger | 67244 6 | Ti silver | matt | 365 | L | 57 - 61 | 1 |
| CliffHanger | 66240 9 | chalk grey | matt | 300 | S | 51 - 55 | 1 |
| CliffHanger | 66253 9 | chalk grey | matt | 325 | M | 54 - 58 | 1 |
| CliffHanger | 67238 5 | chalk grey | matt | 365 | L | 57 - 61 | 1 |
| CliffHanger | 67239 2 | wildberry red | matt | 300 | S | 51 - 55 | 1 |
| CliffHanger | 67240 8 | wildberry red | matt | 325 | M | 54 - 58 | 1 |
| CliffHanger | 67241 5 | wildberry red | matt | 365 | L | 57 - 61 | 1 |
| CliffHanger MIPS | 65551 7 | metallic copper | matt | 330 | S | 51 - 55 | 1 |
| CliffHanger MIPS | 65552 4 | metallic copper | matt | 350 | M | 54 - 58 | 1 |
| CliffHanger MIPS | 65553 1 | metallic copper | matt | 390 | L | 57 - 61 | 1 |
| CliffHanger MIPS | 67248 4 | pine green | matt | 330 | S | 51 - 55 | 1 |
| CliffHanger MIPS | 67249 1 | pine green | matt | 350 | M | 54 - 58 | 1 |
| CliffHanger MIPS | 67306 1 | pine green | matt | 390 | L | 57 - 61 | 1 |
| CliffHanger MIPS | 67245 3 | shiny white | shiny | 330 | S | 51 - 55 | 1 |
| CliffHanger MIPS | 67246 0 | shiny white | shiny | 350 | M | 54 - 58 | 1 |
| CliffHanger MIPS | 67247 7 | shiny white | shiny | 390 | L | 57 - 61 | 1 |
| CliffHanger MIPS | 67310 8 | iced mint | matt | 330 | S | 51 - 55 | 1 |
| CliffHanger MIPS | 67507 2 | iced mint | matt | 350 | M | 54 - 58 | 1 |
| CliffHanger MIPS | 67508 9 | iced mint | matt | 390 | L | 57 - 61 | 1 |
| CliffHanger MIPS | 65554 8 | concrete grey | matt | 330 | S | 51 - 55 | 1 |
| CliffHanger MIPS | 66485 4 | concrete grey | matt | 350 | M | 54 - 58 | 1 |
| CliffHanger MIPS | 65555 5 | concrete grey | matt | 390 | L | 57 - 61 | 1 |
| CliffHanger MIPS | 65542 5 | velvet black | matt | 330 | S | 51 - 55 | 1 |
| CliffHanger MIPS | 65543 2 | velvet black | matt | 350 | M | 54 - 58 | 1 |
| CliffHanger MIPS | 65544 9 | velvet black | matt | 390 | L | 57 - 61 | 1 |
| CliffHanger QUIN | 65556 2 | velvet black | matt | 305 | S | 51 - 55 | 1 |
| CliffHanger QUIN | 65557 9 | velvet black | matt | 330 | M | 54 - 58 | 1 |
| CliffHanger QUIN | 65558 6 | velvet black | matt | 370 | L | 57 - 61 | 1 |
| CliffHanger QUIN | 65734 4 | shiny white | shiny | 305 | S | 51 - 55 | 1 |
| CliffHanger QUIN | 65737 5 | shiny white | shiny | 330 | M | 54 - 58 | 1 |
| CliffHanger QUIN | 65738 2 | shiny white | shiny | 370 | L | 57 - 61 | 1 |
| Capteur Quin Slim | 69319 9 | | | | | | 1 |

VTT



MOVENTOR 2.0

VUES



wildberry red



wildberry red



CARACTÉRISTIQUES



Zoom Ace MTB



Boucle



GogFit



TriVider



Visière réglable en hauteur

ACCESSOIRES

- Housse ABUS
- Capteur Quin
- Set de mousse pour Moventor 2.0 S/M/L

TECHNOLOGIE



VARIANTES



concrete grey



iced mint



midnight blue



pine green



shiny white



velvet black



chalk grey



Ti silver



Mips

metallic copper



Mips

velvet black



Mips

concrete grey



Mips

iced mint



Mips

pine green



Mips

shiny white



Mips

shiny white



Mips

velvet black

| Article | EAN 4003318 | Couleur | Finition | Poids g | Taille | Tour de tête cm | Unité emb. |
|-------------------|----------------|-----------------|----------|---------|--------|-----------------|---------------|
| Moventor 2.0 | 65502 9 | concrete grey | shiny | 290 | S | 51 - 55 | 1 |
| Moventor 2.0 | 65503 6 | concrete grey | shiny | 300 | M | 54 - 58 | 1 |
| Moventor 2.0 | 65504 3 | concrete grey | shiny | 320 | L | 57 - 61 | 1 |
| Moventor 2.0 | 65505 0 | iced mint | shiny | 290 | S | 51 - 55 | 1 |
| Moventor 2.0 | 65506 7 | iced mint | shiny | 300 | M | 54 - 58 | 1 |
| Moventor 2.0 | 65507 4 | iced mint | shiny | 320 | L | 57 - 61 | 1 |
| Moventor 2.0 | 65496 1 | midnight blue | shiny | 290 | S | 51 - 55 | 1 |
| Moventor 2.0 | 65497 8 | midnight blue | shiny | 300 | M | 54 - 58 | 1 |
| Moventor 2.0 | 65498 5 | midnight blue | shiny | 320 | L | 57 - 61 | 1 |
| Moventor 2.0 | 65499 2 | pine green | shiny | 290 | S | 51 - 55 | 1 |
| Moventor 2.0 | 65500 5 | pine green | shiny | 300 | M | 54 - 58 | 1 |
| Moventor 2.0 | 65501 2 | pine green | shiny | 320 | L | 57 - 61 | 1 |
| Moventor 2.0 | 65493 0 | shiny white | shiny | 290 | S | 51 - 55 | 1 |
| Moventor 2.0 | 65494 7 | shiny white | shiny | 300 | M | 54 - 58 | 1 |
| Moventor 2.0 | 65495 4 | shiny white | shiny | 320 | L | 57 - 61 | 1 |
| Moventor 2.0 | 65490 9 | velvet black | matt | 290 | S | 51 - 55 | 1 |
| Moventor 2.0 | 65491 6 | velvet black | matt | 300 | M | 54 - 58 | 1 |
| Moventor 2.0 | 65492 3 | velvet black | matt | 320 | L | 57 - 61 | 1 |
| Moventor 2.0 | 74661 1 | chalk grey | matt | 290 | S | 51 - 55 | 1 |
| Moventor 2.0 | 78600 6 | chalk grey | matt | 300 | M | 54 - 58 | 1 |
| Moventor 2.0 | 83317 5 | chalk grey | matt | 320 | L | 57 - 61 | 1 |
| Moventor 2.0 | 83318 2 | wildberry red | matt | 290 | S | 51 - 55 | 1 |
| Moventor 2.0 | 83319 9 | wildberry red | matt | 300 | M | 54 - 58 | 1 |
| Moventor 2.0 | 83320 5 | wildberry red | matt | 320 | L | 57 - 61 | 1 |
| Moventor 2.0 | 83321 2 | Ti silver | matt | 290 | S | 51 - 55 | 1 |
| Moventor 2.0 | 84127 9 | Ti silver | matt | 300 | M | 54 - 58 | 1 |
| Moventor 2.0 | 84250 4 | Ti silver | matt | 320 | L | 57 - 61 | 1 |
| Moventor 2.0 MIPS | 65511 1 | metallic copper | shiny | 320 | S | 51 - 55 | 1 |
| Moventor 2.0 MIPS | 65512 8 | metallic copper | shiny | 330 | M | 54 - 58 | 1 |
| Moventor 2.0 MIPS | 65513 5 | metallic copper | shiny | 350 | L | 51 - 61 | 1 |
| Moventor 2.0 MIPS | 65508 1 | velvet black | matt | 320 | S | 51 - 55 | 1 |
| Moventor 2.0 MIPS | 65509 8 | velvet black | matt | 330 | M | 54 - 58 | 1 |
| Moventor 2.0 MIPS | 65510 4 | velvet black | matt | 350 | L | 57 - 61 | 1 |
| Moventor 2.0 MIPS | 65514 2 | concrete grey | shiny | 320 | S | 51 - 55 | 1 |
| Moventor 2.0 MIPS | 65515 9 | concrete grey | shiny | 330 | M | 54 - 58 | 1 |
| Moventor 2.0 MIPS | 65516 6 | concrete grey | shiny | 350 | L | 57 - 61 | 1 |
| Moventor 2.0 MIPS | 88487 0 | iced mint | matt | 320 | S | 51 - 55 | 1 |
| Moventor 2.0 MIPS | 88488 7 | iced mint | matt | 330 | M | 54 - 58 | 1 |
| Moventor 2.0 MIPS | 88493 1 | iced mint | matt | 350 | L | 57 - 61 | 1 |
| Moventor 2.0 MIPS | 87870 1 | pine green | matt | 320 | S | 51 - 55 | 1 |
| Moventor 2.0 MIPS | 88465 8 | pine green | matt | 330 | M | 54 - 58 | 1 |
| Moventor 2.0 MIPS | 88466 5 | pine green | matt | 350 | L | 57 - 61 | 1 |
| Moventor 2.0 MIPS | 84522 2 | shiny white | matt | 320 | S | 51 - 55 | 1 |
| Moventor 2.0 MIPS | 84523 9 | shiny white | matt | 330 | M | 54 - 58 | 1 |
| Moventor 2.0 MIPS | 85421 7 | shiny white | matt | 350 | L | 57 - 61 | 1 |
| Moventor 2.0 QUIN | 65517 3 | velvet black | matt | 295 | S | 51 - 55 | 1 |
| Moventor 2.0 QUIN | 65518 0 | velvet black | matt | 305 | M | 54 - 58 | 1 |
| Moventor 2.0 QUIN | 65519 7 | velvet black | matt | 325 | L | 57 - 61 | 1 |
| Moventor 2.0 QUIN | 65520 3 | shiny white | shiny | 295 | S | 51 - 55 | 1 |
| Moventor 2.0 QUIN | 65521 0 | shiny white | shiny | 305 | M | 54 - 58 | 1 |
| Moventor 2.0 QUIN | 65522 7 | shiny white | shiny | 325 | L | 57 - 61 | 1 |
| Capteur Quin | 68838 6 | | | | | | 1 |

VTT



MODROP

VUES



chalk grey



chalk grey



CARACTÉRISTIQUES



Zoom Ace MTB



Boucle



TriVider



GoggFit



Visière réglable en hauteur

ACCESSOIRES

- Housse ABUS
- Capteur Quin
- Set de mousse pour MoDrop S/M/L

TECHNOLOGIE



VARIANTES



pine green



velvet black



concrete grey



midnight blue



iced mint



polar white



wildberry red



Ti silver



velvet black



concrete grey



metallic copper



shiny white



pine green



iced mint



polar white



velvet black

| Article | EAN 4003318 | Couleur | Finition | Poids g | Taille | Tour de tête cm | Unité emb. |
|---------------|----------------|-----------------|----------|---------|--------|-----------------|---------------|
| MoDrop | 64985 1 | pine green | matt | 310 | S | 51 - 55 | 1 |
| MoDrop | 64986 8 | pine green | matt | 330 | M | 54 - 58 | 1 |
| MoDrop | 64987 5 | pine green | matt | 360 | L | 57 - 61 | 1 |
| MoDrop | 64849 6 | velvet black | matt | 310 | S | 51 - 55 | 1 |
| MoDrop | 64851 9 | velvet black | matt | 330 | M | 54 - 58 | 1 |
| MoDrop | 64850 2 | velvet black | matt | 360 | L | 57 - 61 | 1 |
| MoDrop | 64852 6 | concrete grey | matt | 310 | S | 51 - 55 | 1 |
| MoDrop | 64853 3 | concrete grey | matt | 330 | M | 54 - 58 | 1 |
| MoDrop | 64854 0 | concrete grey | matt | 360 | L | 57 - 61 | 1 |
| MoDrop | 64861 8 | midnight blue | matt | 310 | S | 51 - 55 | 1 |
| MoDrop | 64863 2 | midnight blue | matt | 330 | M | 54 - 58 | 1 |
| MoDrop | 64871 7 | midnight blue | matt | 360 | L | 57 - 61 | 1 |
| MoDrop | 64988 2 | iced mint | matt | 310 | S | 51 - 55 | 1 |
| MoDrop | 64989 9 | iced mint | matt | 330 | M | 54 - 58 | 1 |
| MoDrop | 64990 5 | iced mint | matt | 360 | L | 57 - 61 | 1 |
| MoDrop | 66475 5 | polar white | matt | 310 | S | 51 - 55 | 1 |
| MoDrop | 66476 2 | polar white | matt | 330 | M | 54 - 58 | 1 |
| MoDrop | 66477 9 | polar white | matt | 360 | L | 57 - 61 | 1 |
| MoDrop | 67601 7 | wildberry red | matt | 310 | S | 51 - 55 | 1 |
| MoDrop | 67612 3 | wildberry red | matt | 330 | M | 54 - 58 | 1 |
| MoDrop | 68077 9 | wildberry red | matt | 360 | L | 57 - 61 | 1 |
| MoDrop | 68981 9 | Ti silver | matt | 310 | S | 51 - 55 | 1 |
| MoDrop | 69056 3 | Ti silver | matt | 330 | M | 54 - 58 | 1 |
| MoDrop | 69079 2 | Ti silver | matt | 360 | L | 57 - 61 | 1 |
| MoDrop | 67531 7 | chalk grey | matt | 310 | S | 51 - 55 | 1 |
| MoDrop | 67585 0 | chalk grey | matt | 330 | M | 54 - 58 | 1 |
| MoDrop | 67594 2 | chalk grey | matt | 360 | L | 57 - 61 | 1 |
| MoDrop MIPS | 65739 9 | velvet black | matt | 340 | S | 51 - 55 | 1 |
| MoDrop MIPS | 65740 5 | velvet black | matt | 370 | M | 54 - 58 | 1 |
| MoDrop MIPS | 65741 2 | velvet black | matt | 390 | L | 57 - 61 | 1 |
| MoDrop MIPS | 65755 9 | concrete grey | matt | 340 | S | 51 - 55 | 1 |
| MoDrop MIPS | 65756 6 | concrete grey | matt | 370 | M | 54 - 58 | 1 |
| MoDrop MIPS | 65757 3 | concrete grey | matt | 390 | L | 57 - 61 | 1 |
| MoDrop MIPS | 65742 9 | metallic copper | matt | 340 | S | 51 - 55 | 1 |
| MoDrop MIPS | 65753 5 | metallic copper | matt | 370 | M | 54 - 58 | 1 |
| MoDrop MIPS | 65754 2 | metallic copper | matt | 390 | L | 57 - 61 | 1 |
| MoDrop MIPS | 69080 8 | shiny white | shiny | 340 | S | 51 - 55 | 1 |
| MoDrop MIPS | 69106 5 | shiny white | shiny | 370 | M | 54 - 58 | 1 |
| MoDrop MIPS | 69180 5 | shiny white | shiny | 390 | L | 57 - 61 | 1 |
| MoDrop MIPS | 69383 0 | pine green | matt | 340 | S | 51 - 55 | 1 |
| MoDrop MIPS | 69384 7 | pine green | matt | 370 | M | 54 - 58 | 1 |
| MoDrop MIPS | 72993 5 | pine green | matt | 390 | L | 57 - 61 | 1 |
| MoDrop MIPS | 72996 6 | iced mint | matt | 340 | S | 51 - 55 | 1 |
| MoDrop MIPS | 72997 3 | iced mint | matt | 370 | M | 54 - 58 | 1 |
| MoDrop MIPS | 72998 0 | iced mint | matt | 390 | L | 57 - 61 | 1 |
| MoDrop QUIN | 65797 9 | polar white | matt | 315 | S | 51 - 55 | 1 |
| MoDrop QUIN | 65798 6 | polar white | matt | 335 | M | 54 - 58 | 1 |
| MoDrop QUIN | 65799 3 | polar white | matt | 365 | L | 57 - 61 | 1 |
| MoDrop QUIN | 65758 0 | velvet black | matt | 315 | S | 51 - 55 | 1 |
| MoDrop QUIN | 65795 5 | velvet black | matt | 335 | M | 54 - 58 | 1 |
| MoDrop QUIN | 65796 2 | velvet black | matt | 365 | L | 57 - 61 | 1 |
| Captteur Quin | 68838 6 | | | | | | 1 |

VTT



MOTRIP

VUES



shiny white



shiny white



CARACTÉRISTIQUES



Zoom Ace MTB



Boucle



GoggFit



Visière réglable en hauteur

ACCESSOIRES

- Housse ABUS
- Set de mousse pour MoTrip S/M/L

TECHNOLOGIE



VARIANTES



shiny black



midnight blue



concrete grey



shiny black



shiny white

| Article | EAN 4003318 | Couleur | Finition | Poids g | Taille | Tour de tête cm | Unité emb. |
|-------------|----------------|---------------|----------|---------|--------|-----------------|---------------|
| MoTrip | 64709 3 | shiny white | shiny | 320 | S | 51 - 55 | 1 |
| MoTrip | 64712 3 | shiny white | shiny | 340 | M | 54 - 58 | 1 |
| MoTrip | 64710 9 | shiny white | shiny | 350 | L | 57 - 61 | 1 |
| MoTrip | 64706 2 | shiny black | shiny | 320 | S | 51 - 55 | 1 |
| MoTrip | 64707 9 | shiny black | shiny | 340 | M | 54 - 58 | 1 |
| MoTrip | 64708 6 | shiny black | shiny | 350 | L | 57 - 61 | 1 |
| MoTrip | 64711 6 | midnight blue | shiny | 320 | S | 51 - 55 | 1 |
| MoTrip | 64713 0 | midnight blue | shiny | 340 | M | 54 - 58 | 1 |
| MoTrip | 64714 7 | midnight blue | shiny | 350 | L | 57 - 61 | 1 |
| MoTrip | 64724 6 | concrete grey | shiny | 320 | S | 51 - 55 | 1 |
| MoTrip | 64754 3 | concrete grey | shiny | 340 | M | 54 - 58 | 1 |
| MoTrip | 64847 2 | concrete grey | shiny | 350 | L | 57 - 61 | 1 |
| MoTrip MIPS | 88496 2 | shiny black | shiny | 350 | S | 51 - 55 | 1 |
| MoTrip MIPS | 88499 3 | shiny black | shiny | 370 | M | 54 - 58 | 1 |
| MoTrip MIPS | 88508 2 | shiny black | shiny | 380 | L | 57 - 61 | 1 |
| MoTrip MIPS | 88821 2 | shiny white | shiny | 350 | S | 51 - 55 | 1 |
| MoTrip MIPS | 89177 9 | shiny white | shiny | 380 | L | 57 - 61 | 1 |
| MoTrip MIPS | 88977 6 | shiny white | shiny | 370 | M | 54 - 58 | 1 |

VTT



BUTEO



DONNÉES TECHNIQUES

- Revêtement anti-buée
- Élastique de 40 mm pour un ajustement sans glissement
- Couche de polaire pour un confort maximal
- Protège-nez pour un ajustement confortable et sûr
- Disponible avec des verres transparents et réfléchissants teintés

VARIANTES



infra red

neon yellow

velvet black

| Article | EAN 4003318 | Couleur | Finition | Poids g | Taille | Tour de tête cm | Unité emb. |
|-------------------------|----------------|--------------|----------|---------|-------------|--------------------|---------------|
| Buteo infra red | 68933 8 | infra red | | 140 | universelle | | 1 |
| Buteo neon yellow | 68932 1 | neon yellow | | 140 | universelle | | 1 |
| Buteo polar white | 68931 4 | polar white | | 140 | universelle | | 1 |
| Buteo velvet black | 68930 7 | velvet black | | 140 | universelle | | 1 |
| Buteo Verre de rechange | 68934 5 | clear | | 15 | universelle | | 1 |
| Buteo Verre de rechange | 68935 2 | smoky | | 15 | universelle | | 1 |
| Buteo Verre de rechange | 68936 9 | red chrome | | 15 | universelle | | 1 |
| Buteo Verre de rechange | 68937 6 | black chrome | | 15 | universelle | | 1 |



VTT

URBAIN



PEDELEC 2.0 ACE



champagne gold

Page 204



velvet black

Page 204



signal yellow

Page 204



pearl white

Page 204



midnight blue

Page 204



race grey

Page 204



titan

Page 204



blaze red

Page 204

PEDELEC 2.0



race grey

Page 206



velvet black

Page 206



signal yellow

Page 206



pearl white

Page 206



midnight blue

Page 206



titan

Page 206



champagne gold

Page 206



blaze red

Page 206



Mips

velvet black

Page 206



Mips

signal yellow

Page 206



Mips

silver edition

Page 206

PEDELEC 1.1



steel blue

Page 208



titan

Page 208



pearl white

Page 208



black edition

Page 208

HUD-Y ACE



champagne gold

Page 210



gleam silver

Page 210



iced blue

Page 210



moss green

Page 210



shiny white

Page 210



goldfish orange

Page 210



velvet black

Page 210

HUD-Y



iced blue

Page 212



metallic copper

Page 212



moss green

Page 212



gleam silver

Page 212



velvet black

Page 212



titan

Page 212



signal yellow

Page 212



race grey

Page 212



midnight blue

Page 212



flower white

Page 212



champagne gold

Page 212



shiny white

Page 212



goldfish orange

Page 212

URBAN-I 3.0 ACE



gleam silver

Page 214



moss green

Page 214



iced blue

Page 214



velvet black

Page 214



goldfish orange

Page 214



polar white

Page 214



metallic copper

Page 214

URBAN-I 3.0



velvet black

Page 216



titan

Page 216



street art

Page 216



polar white

Page 216



living coral

Page 216



jade green

Page 216



glacier blue

Page 216



flower art

Page 216



core green

Page 216



core blue

Page 216



Signal yellow

Page 216



signal silver

Page 216



signal orange

Page 216



velvet black

Page 216



titan

Page 216



signal yellow

Page 216

PURL-Y ACE



midnight blue

Page 218



velvet black

Page 218



titan

Page 218



polar white

Page 218



metallic copper

Page 218



moss green

Page 218



champagne gold

Page 218



iced blue

Page 218



signal yellow

Page 218

PURL-Y



moss green

Page 220



shiny black

Page 220



titan

Page 220



shiny white

Page 220



metallic copper

Page 220



midnight blue

Page 220



champagne gold

Page 220



iced blue

Page 220



signal yellow

Page 220

HYBAN 2.0 LED



signal black

Page 222



signal yellow

Page 222



signal silver

Page 222



signal glacier

Page 222

HYBAN 2.0 ACE



titan

Page 224



velvet black

Page 224



signal yellow

Page 224



polar white

Page 224

HYBAN 2.0



chrome silver

Page 226



velvet black

Page 226



titan

Page 226



polar white

Page 226



living coral

Page 226



jade green

Page 226



glacier blue

Page 226



core green

Page 226



core blue

Page 226



chrome rosé

Page 226



signal orange

Page 226



signal silver

Page 226



signal yellow

Page 226



Mips

velvet black

Page 226



Mips

titan

Page 226



Mips

signal yellow

Page 226

SKURB ACE



city vibes

Page 228



goldfish orange

Page 228



moss green

Page 228



velvet black

Page 228



silver white

Page 228



glacier blue

Page 228

SKURB



goldfish orange

Page 230



moss green

Page 230



velvet black

Page 230



titan

Page 230



pearl white

Page 230



midnight blue

Page 230



velvet black

Page 230



polar white

Page 230



concrete grey

Page 230

SCRAPER 3.0 ACE



ultra blue

Page 232



velvet black

Page 232



concrete grey

Page 232

SCRAPER 3.0



velvet black

Page 234



concrete grey

Page 234



ultra blue

Page 234



signal orange

Page 234



polar matt

Page 234

ADURO 3.0



purple waves

Page 236



velvet black

Page 236



polar white

Page 236



midnight blue

Page 236



titan

Page 236



race black

Page 236



glacier blue

Page 236



blaze red

Page 236



race grey

Page 236



maori
blackberry

Page 236



white art

Page 236



orange palm

Page 236



signal yellow

Page 236

PEDELEC 2.0 ACE

VUES



champagne gold



champagne gold



CARACTÉRISTIQUES



Zoom Ace Urban



Fidlock



GlowStraps



Lumière USB



Capuche

ACCESSOIRES

- Visière fumée ou transparente Pedelec 2.0, Hyban 2.0, HUD-Y
- Kit hiver pour Pedelec 2.0

TECHNOLOGIE



NTA 8776

VARIANTES



velvet black



signal yellow



pearl white



midnight blue



race grey



titan



blaze red

| Article | EAN 4003318 | Couleur | Finition | Poids g | Taille | Tour de tête cm | Unité emb. |
|------------------------------------|----------------|----------------|----------|---------|-------------|-----------------|---------------|
| Pedelec 2.0 ACE | 66732 9 | velvet black | matt | 390 | S | 51 - 55 | 1 |
| Pedelec 2.0 ACE | 81925 4 | velvet black | matt | 410 | M | 52 - 57 | 1 |
| Pedelec 2.0 ACE | 81929 2 | velvet black | matt | 430 | L | 56 - 62 | 1 |
| Pedelec 2.0 ACE | 66735 0 | signal yellow | shiny | 390 | S | 51 - 55 | 1 |
| Pedelec 2.0 ACE | 81928 5 | signal yellow | shiny | 410 | M | 52 - 57 | 1 |
| Pedelec 2.0 ACE | 81932 2 | signal yellow | shiny | 430 | L | 56 - 62 | 1 |
| Pedelec 2.0 ACE | 67337 5 | pearl white | shiny | 390 | S | 51 - 55 | 1 |
| Pedelec 2.0 ACE | 67338 2 | pearl white | shiny | 410 | M | 52 - 57 | 1 |
| Pedelec 2.0 ACE | 67339 9 | pearl white | shiny | 430 | L | 56 - 62 | 1 |
| Pedelec 2.0 ACE | 66736 7 | midnight blue | matt | 390 | S | 51 - 55 | 1 |
| Pedelec 2.0 ACE | 81927 8 | midnight blue | matt | 410 | M | 52 - 57 | 1 |
| Pedelec 2.0 ACE | 81931 5 | midnight blue | matt | 430 | L | 56 - 62 | 1 |
| Pedelec 2.0 ACE | 91909 1 | race grey | shiny | 390 | S | 51 - 55 | 1 |
| Pedelec 2.0 ACE | 91910 7 | race grey | shiny | 410 | M | 52 - 57 | 1 |
| Pedelec 2.0 ACE | 91911 4 | race grey | shiny | 430 | L | 56 - 62 | 1 |
| Pedelec 2.0 ACE | 91906 0 | titan | matt | 390 | S | 51 - 55 | 1 |
| Pedelec 2.0 ACE | 91907 7 | titan | matt | 410 | M | 52 - 57 | 1 |
| Pedelec 2.0 ACE | 91908 4 | titan | matt | 430 | L | 56 - 62 | 1 |
| Pedelec 2.0 ACE | 91912 1 | champagne gold | shiny | 390 | S | 51 - 55 | 1 |
| Pedelec 2.0 ACE | 91913 8 | champagne gold | shiny | 410 | M | 52 - 57 | 1 |
| Pedelec 2.0 ACE | 91914 5 | champagne gold | shiny | 430 | L | 56 - 62 | 1 |
| Pedelec 2.0 ACE | 91917 6 | blaze red | shiny | 390 | S | 51 - 55 | 1 |
| Pedelec 2.0 ACE | 91918 3 | blaze red | shiny | 410 | M | 52 - 57 | 1 |
| Pedelec 2.0 ACE | 91919 0 | blaze red | shiny | 430 | L | 56 - 62 | 1 |
| Visière Pedelec 2.0 & Hyban 2.0 | 82888 1 | fumée | | | universelle | | 1 |
| Visière Pedelec 2.0 & Hyban 2.0 | 82889 8 | transparente | | | universelle | | 1 |

Urban



PEDELEC 2.0

VUES



race grey



race grey



CARACTÉRISTIQUES



Zoom Ace Urban



Fidlock



GlowStraps



Lumière USB



Capuche

ACCESSOIRES

- Visière fumée ou transparente
Pedelec 2.0, Hyban 2.0, HUD-Y
- Kit hiver
Pedelec 2.0

TECHNOLOGIE



VARIANTES



velvet black



signal yellow



pearl white



midnight blue



titan



champagne gold



blaze red



velvet black



signal yellow



silver edition

| Article | EAN 4003318 | Couleur | Finition | Poids g | Taille | Tour de tête cm | Unité emb. |
|------------------|----------------|----------------|----------|---------|--------|-----------------|---------------|
| Pedelec 2.0 | 40597 6 | velvet black | matt | 330 | S | 51 - 55 | 1 |
| Pedelec 2.0 | 81919 3 | velvet black | matt | 350 | M | 52 - 57 | 1 |
| Pedelec 2.0 | 81913 1 | velvet black | matt | 370 | L | 56 - 62 | 1 |
| Pedelec 2.0 | 40595 2 | signal yellow | shiny | 330 | S | 51 - 55 | 1 |
| Pedelec 2.0 | 81922 3 | signal yellow | shiny | 350 | M | 52 - 57 | 1 |
| Pedelec 2.0 | 81916 2 | signal yellow | shiny | 370 | L | 56 - 62 | 1 |
| Pedelec 2.0 | 40593 8 | pearl white | shiny | 330 | S | 51 - 55 | 1 |
| Pedelec 2.0 | 40188 6 | pearl white | shiny | 350 | M | 52 - 57 | 1 |
| Pedelec 2.0 | 40189 3 | pearl white | shiny | 370 | L | 56 - 62 | 1 |
| Pedelec 2.0 | 40297 5 | midnight blue | matt | 330 | S | 51 - 55 | 1 |
| Pedelec 2.0 | 81921 6 | midnight blue | matt | 350 | M | 52 - 57 | 1 |
| Pedelec 2.0 | 81915 5 | midnight blue | matt | 370 | L | 56 - 62 | 1 |
| Pedelec 2.0 | 91894 0 | titan | matt | 330 | S | 51 - 55 | 1 |
| Pedelec 2.0 | 91895 7 | titan | matt | 350 | M | 52 - 57 | 1 |
| Pedelec 2.0 | 91896 4 | titan | matt | 370 | L | 56 - 62 | 1 |
| Pedelec 2.0 | 91900 8 | champagne gold | shiny | 330 | S | 51 - 55 | 1 |
| Pedelec 2.0 | 91901 5 | champagne gold | shiny | 350 | M | 52 - 57 | 1 |
| Pedelec 2.0 | 91902 2 | champagne gold | shiny | 370 | L | 56 - 62 | 1 |
| Pedelec 2.0 | 91897 1 | race grey | shiny | 330 | S | 51 - 55 | 1 |
| Pedelec 2.0 | 91898 8 | race grey | shiny | 350 | M | 52 - 57 | 1 |
| Pedelec 2.0 | 91899 5 | race grey | shiny | 370 | L | 56 - 62 | 1 |
| Pedelec 2.0 | 91903 9 | blaze red | shiny | 330 | S | 51 - 55 | 1 |
| Pedelec 2.0 | 91904 6 | blaze red | shiny | 350 | M | 52 - 57 | 1 |
| Pedelec 2.0 | 91905 3 | blaze red | shiny | 370 | L | 56 - 62 | 1 |
| Pedelec 2.0 MIPS | 89193 9 | velvet black | matt | 390 | L | 56 - 62 | 1 |
| Pedelec 2.0 MIPS | 89194 6 | velvet black | matt | 370 | M | 52 - 57 | 1 |
| Pedelec 2.0 MIPS | 89197 7 | signal yellow | shiny | 390 | L | 56 - 62 | 1 |
| Pedelec 2.0 MIPS | 89198 4 | signal yellow | shiny | 370 | M | 52 - 57 | 1 |
| Pedelec 2.0 MIPS | 89195 3 | silver edition | matt | 390 | L | 56 - 62 | 1 |
| Pedelec 2.0 MIPS | 89196 0 | silver edition | matt | 370 | M | 52 - 57 | 1 |



PEDELEC 1.1

VUES



steel blue



steel blue



ACCESSOIRES

- Housse ABUS

CARACTÉRISTIQUES



Zoom Evo Adult



Fidlock



LED top



Capuche

TECHNOLOGIE



4/9



NTA 8776

VARIANTES



titan



pearl white



black edition

| Article | EAN 4003318 | Couleur | Finition | Poids g | Taille | Tour de tête cm | Unité emb. |
|-------------|----------------|---------------|----------|---------|--------|-----------------|---------------|
| Pedelec 1.1 | 81907 0 | titan | matt | 350 | M | 52 - 57 | 1 |
| Pedelec 1.1 | 81908 7 | titan | matt | 370 | L | 56 - 62 | 1 |
| Pedelec 1.1 | 81909 4 | steel blue | shiny | 350 | M | 52 - 57 | 1 |
| Pedelec 1.1 | 81910 0 | steel blue | shiny | 370 | L | 56 - 62 | 1 |
| Pedelec 1.1 | 81911 7 | pearl white | shiny | 350 | M | 52 - 57 | 1 |
| Pedelec 1.1 | 81912 4 | pearl white | shiny | 370 | L | 56 - 62 | 1 |
| Pedelec 1.1 | 81905 6 | black edition | matt | 350 | M | 52 - 57 | 1 |
| Pedelec 1.1 | 81906 3 | black edition | matt | 370 | L | 56 - 62 | 1 |



HUD-Y ACE

VUES



champagne gold



champagne gold



CARACTÉRISTIQUES



Zoom Ace Urban



Fidlock



TriVider



Feu arrière USB magnétique

ACCESSOIRES

- Housse ABUS
- Visière fumée ou transparente
Pedelec 2.0, Hyban 2.0, HUD-Y
- Lumière USB

TECHNOLOGIE



VARIANTES



gleam silver

iced blue

moss green

shiny white

goldfish orange

velvet black

| Article | EAN 4003318 | Couleur | Finition | Poids g | Taille | Tour de tête cm | Unité emb. |
|-----------------------|----------------|-----------------|----------|---------|-------------|-----------------|---------------|
| HUD-Y ACE | 99168 4 | champange gold | matt | 400 | S | 51 - 55 | 1 |
| HUD-Y ACE | 99169 1 | champange gold | matt | 430 | M | 54 - 58 | 1 |
| HUD-Y ACE | 99170 7 | champange gold | matt | 460 | L | 57 - 61 | 1 |
| HUD-Y ACE | 99165 3 | gleam silver | shiny | 400 | S | 51 - 55 | 1 |
| HUD-Y ACE | 99166 0 | gleam silver | shiny | 430 | M | 54 - 58 | 1 |
| HUD-Y ACE | 99167 7 | gleam silver | shiny | 460 | L | 57 - 61 | 1 |
| HUD-Y ACE | 99162 2 | iced blue | shiny | 400 | S | 51 - 55 | 1 |
| HUD-Y ACE | 99163 9 | iced blue | shiny | 430 | M | 54 - 58 | 1 |
| HUD-Y ACE | 99164 6 | iced blue | shiny | 460 | L | 57 - 61 | 1 |
| HUD-Y ACE | 99159 2 | moss green | shiny | 400 | S | 51 - 55 | 1 |
| HUD-Y ACE | 99160 8 | moss green | shiny | 430 | M | 54 - 58 | 1 |
| HUD-Y ACE | 99161 5 | moss green | shiny | 460 | L | 57 - 61 | 1 |
| HUD-Y ACE | 91995 4 | shiny white | shiny | 400 | S | 51 - 55 | 1 |
| HUD-Y ACE | 91996 1 | shiny white | shiny | 430 | M | 54 - 58 | 1 |
| HUD-Y ACE | 91997 8 | shiny white | shiny | 460 | L | 57 - 61 | 1 |
| HUD-Y ACE | 91998 5 | goldfish orange | shiny | 400 | S | 51 - 55 | 1 |
| HUD-Y ACE | 91999 2 | goldfish orange | shiny | 430 | M | 54 - 58 | 1 |
| HUD-Y ACE | 04486 1 | goldfish orange | shiny | 460 | L | 57 - 61 | 1 |
| HUD-Y ACE | 91992 3 | velvet black | matt | 400 | S | 51 - 55 | 1 |
| HUD-Y ACE | 91993 0 | velvet black | matt | 430 | M | 54 - 58 | 1 |
| HUD-Y ACE | 91994 7 | velvet black | matt | 460 | L | 57 - 61 | 1 |
| HUD-Y ACE Visières | 82888 1 | fumée | | | universelle | | 1 |
| HUD-Y ACE Visières | 82889 8 | transparente | | | universelle | | 1 |
| Fixation pour visière | 82890 4 | | | | universelle | | 1 |



HUD-Y

VUES



iced blue



iced blue



CARACTÉRISTIQUES



Zoom Ace Urban



Fidlock



TriVider



Feu arrière USB magnétique



Visières flip flop

ACCESSOIRES

- Housse ABUS
- Lumière USB

TECHNOLOGIE



VARIANTES



metallic copper



moss green



gleam silver



velvet black



titan



signal yellow



race grey



midnight blue



flower white



champagne gold



shiny white



goldfish orange

| Article | EAN 4003318 | Couleur | Finition | Poids g | Taille | Tour de tête cm | Unité emb. |
|---------|----------------|-----------------|----------|---------|--------|-----------------|---------------|
| HUD-Y | 97932 3 | metallic copper | matt | 280 | S | 51 - 55 | 1 |
| HUD-Y | 97934 7 | metallic copper | matt | 300 | M | 54 - 58 | 1 |
| HUD-Y | 97935 4 | metallic copper | matt | 330 | L | 57 - 61 | 1 |
| HUD-Y | 97936 1 | moss green | shiny | 280 | S | 51 - 55 | 1 |
| HUD-Y | 97937 8 | moss green | shiny | 300 | M | 54 - 58 | 1 |
| HUD-Y | 97938 5 | moss green | shiny | 330 | L | 57 - 61 | 1 |
| HUD-Y | 97939 2 | iced blue | shiny | 280 | S | 51 - 55 | 1 |
| HUD-Y | 97940 8 | iced blue | shiny | 300 | M | 54 - 58 | 1 |
| HUD-Y | 97941 5 | iced blue | shiny | 330 | L | 57 - 61 | 1 |
| HUD-Y | 97942 2 | gleam silver | shiny | 280 | S | 51 - 55 | 1 |
| HUD-Y | 97943 9 | gleam silver | shiny | 300 | M | 54 - 58 | 1 |
| HUD-Y | 97944 6 | gleam silver | shiny | 330 | L | 57 - 61 | 1 |
| HUD-Y | 91979 4 | velvet black | matt | 280 | S | 51 - 55 | 1 |
| HUD-Y | 66843 2 | velvet black | matt | 300 | M | 54 - 58 | 1 |
| HUD-Y | 66844 9 | velvet black | matt | 330 | L | 57 - 61 | 1 |
| HUD-Y | 91980 0 | titan | matt | 280 | S | 51 - 55 | 1 |
| HUD-Y | 66947 7 | titan | matt | 300 | M | 54 - 58 | 1 |
| HUD-Y | 67038 1 | titan | matt | 330 | L | 57 - 61 | 1 |
| HUD-Y | 91983 1 | signal yellow | shiny | 280 | S | 51 - 55 | 1 |
| HUD-Y | 67043 5 | signal yellow | shiny | 300 | M | 54 - 58 | 1 |
| HUD-Y | 67044 2 | signal yellow | shiny | 330 | L | 57 - 61 | 1 |
| HUD-Y | 91985 5 | race grey | shiny | 280 | S | 51 - 55 | 1 |
| HUD-Y | 67934 6 | race grey | shiny | 300 | M | 54 - 58 | 1 |
| HUD-Y | 67935 3 | race grey | shiny | 330 | L | 57 - 61 | 1 |
| HUD-Y | 91982 4 | midnight blue | matt | 280 | S | 51 - 55 | 1 |
| HUD-Y | 67041 1 | midnight blue | matt | 300 | M | 54 - 58 | 1 |
| HUD-Y | 67042 8 | midnight blue | matt | 330 | L | 57 - 61 | 1 |
| HUD-Y | 91981 7 | flower white | shiny | 280 | S | 51 - 55 | 1 |
| HUD-Y | 66944 6 | flower white | shiny | 300 | M | 54 - 58 | 1 |
| HUD-Y | 66945 3 | flower white | shiny | 330 | L | 57 - 61 | 1 |
| HUD-Y | 91984 8 | champagne gold | matt | 280 | S | 51 - 55 | 1 |
| HUD-Y | 67039 8 | champagne gold | matt | 300 | M | 54 - 58 | 1 |
| HUD-Y | 67040 4 | champagne gold | matt | 330 | L | 57 - 61 | 1 |
| HUD-Y | 91986 2 | shiny white | shiny | 280 | S | 51 - 55 | 1 |
| HUD-Y | 91987 9 | shiny white | shiny | 300 | M | 54 - 58 | 1 |
| HUD-Y | 91988 6 | shiny white | shiny | 330 | L | 57 - 61 | 1 |
| HUD-Y | 91989 3 | goldfish orange | shiny | 280 | S | 51 - 55 | 1 |
| HUD-Y | 91990 9 | goldfish orange | shiny | 300 | M | 54 - 58 | 1 |
| HUD-Y | 91991 6 | goldfish orange | shiny | 330 | L | 57 - 61 | 1 |

Urban



URBAN-I 3.0 ACE

NEW

VUES



gleam silver



gleam silver



CARACTÉRISTIQUES



Zoom Ace Urban



Fidlock



LED



TriVider

ACCESSOIRES

- Housse ABUS
- Lumière LED

TECHNOLOGIE



VARIANTES



moss green



iced blue



velvet black



goldfish orange



polar white



metallic copper

| Article | EAN 4003318 | Couleur | Finition | Poids g | Taille | Tour de tête cm | Unité emb. |
|-----------------|----------------|-----------------|----------|---------|--------|-----------------|---------------|
| Urban-I 3.0 ACE | 97948 4 | moss green | shiny | 250 | S | 51 - 55 | 1 |
| Urban-I 3.0 ACE | 97949 1 | moss green | shiny | 280 | M | 52 - 58 | 1 |
| Urban-I 3.0 ACE | 97950 7 | moss green | shiny | 300 | L | 56 - 61 | 1 |
| Urban-I 3.0 ACE | 97951 4 | iced blue | shiny | 250 | S | 51 - 55 | 1 |
| Urban-I 3.0 ACE | 97952 1 | iced blue | shiny | 280 | M | 52 - 58 | 1 |
| Urban-I 3.0 ACE | 97953 8 | iced blue | shiny | 300 | L | 56 - 61 | 1 |
| Urban-I 3.0 ACE | 97954 5 | gleam silver | shiny | 250 | S | 51 - 55 | 1 |
| Urban-I 3.0 ACE | 97955 2 | gleam silver | shiny | 280 | M | 52 - 58 | 1 |
| Urban-I 3.0 ACE | 97956 9 | gleam silver | shiny | 300 | L | 56 - 61 | 1 |
| Urban-I 3.0 ACE | 02940 0 | velvet black | matt | 250 | S | 51 - 55 | 1 |
| Urban-I 3.0 ACE | 02999 8 | velvet black | matt | 280 | M | 52 - 58 | 1 |
| Urban-I 3.0 ACE | 03244 8 | velvet black | matt | 300 | L | 56 - 61 | 1 |
| Urban-I 3.0 ACE | 03413 8 | goldfish orange | shiny | 250 | S | 51 - 55 | 1 |
| Urban-I 3.0 ACE | 03414 5 | goldfish orange | shiny | 280 | M | 52 - 58 | 1 |
| Urban-I 3.0 ACE | 03415 2 | goldfish orange | shiny | 300 | L | 56 - 61 | 1 |
| Urban-I 3.0 ACE | 03410 7 | polar white | matt | 250 | S | 51 - 55 | 1 |
| Urban-I 3.0 ACE | 03411 4 | polar white | matt | 280 | M | 52 - 58 | 1 |
| Urban-I 3.0 ACE | 03412 1 | polar white | matt | 300 | L | 56 - 61 | 1 |
| Urban-I 3.0 ACE | 03416 9 | metallic copper | matt | 250 | S | 51 - 55 | 1 |
| Urban-I 3.0 ACE | 03417 6 | metallic copper | matt | 280 | M | 52 - 58 | 1 |
| Urban-I 3.0 ACE | 03418 3 | metallic copper | matt | 300 | L | 56 - 61 | 1 |



URBAN-I 3.0

VUES



velvet black



velvet black



CARACTÉRISTIQUES



Zoom Ace Urban



Fidlock



LED top

ACCESSOIRES

- Housse ABUS
- Lumière LED

TECHNOLOGIE



VARIANTES



titan



street art



polar white



living coral



jade green



glacier blue



flower art



core green



core blue



Signal yellow



signal silver



signal orange



velvet black



titan



signal yellow

| Article | EAN 4003318 | Couleur | Finition | Poids g | Taille | Tour de tête cm | Unité emb. |
|------------------|----------------|---------------|------------|---------|--------|-----------------|---------------|
| Urban-I 3.0 | 86857 3 | velvet black | matt | 250 | S | 51 - 55 | 1 |
| Urban-I 3.0 | 86851 1 | velvet black | matt | 280 | M | 52 - 58 | 1 |
| Urban-I 3.0 | 86852 8 | velvet black | matt | 300 | L | 56 - 61 | 1 |
| Urban-I 3.0 | 86853 5 | velvet black | matt | 325 | XL | 61 - 65 | 1 |
| Urban-I 3.0 | 86862 7 | titan | matt | 250 | S | 51 - 55 | 1 |
| Urban-I 3.0 | 86863 4 | titan | matt | 280 | M | 52 - 58 | 1 |
| Urban-I 3.0 | 86864 1 | titan | matt | 300 | L | 56 - 61 | 1 |
| Urban-I 3.0 | 86865 8 | titan | matt | 325 | XL | 61 - 65 | 1 |
| Urban-I 3.0 | 40192 3 | street art | matt+shiny | 250 | S | 51 - 55 | 1 |
| Urban-I 3.0 | 40193 0 | street art | matt+shiny | 280 | M | 52 - 58 | 1 |
| Urban-I 3.0 | 40194 7 | street art | matt+shiny | 300 | L | 56 - 61 | 1 |
| Urban-I 3.0 | 40195 4 | street art | matt+shiny | 325 | XL | 61 - 65 | 1 |
| Urban-I 3.0 | 86858 0 | polar white | matt | 250 | S | 51 - 55 | 1 |
| Urban-I 3.0 | 86859 7 | polar white | matt | 280 | M | 52 - 58 | 1 |
| Urban-I 3.0 | 86860 3 | polar white | matt | 300 | L | 56 - 61 | 1 |
| Urban-I 3.0 | 86861 0 | polar white | matt | 325 | XL | 61 - 65 | 1 |
| Urban-I 3.0 | 86897 9 | living coral | matt | 250 | S | 51 - 55 | 1 |
| Urban-I 3.0 | 86898 6 | living coral | matt | 280 | M | 52 - 58 | 1 |
| Urban-I 3.0 | 88639 3 | living coral | matt | 300 | L | 56 - 61 | 1 |
| Urban-I 3.0 | 86891 7 | jade green | matt | 250 | S | 51 - 55 | 1 |
| Urban-I 3.0 | 86892 4 | jade green | matt | 280 | M | 52 - 58 | 1 |
| Urban-I 3.0 | 86893 1 | jade green | matt | 300 | L | 56 - 61 | 1 |
| Urban-I 3.0 | 86894 8 | glacier blue | matt | 250 | S | 51 - 55 | 1 |
| Urban-I 3.0 | 86895 5 | glacier blue | matt | 280 | M | 52 - 58 | 1 |
| Urban-I 3.0 | 86896 2 | glacier blue | matt | 300 | L | 56 - 61 | 1 |
| Urban-I 3.0 | 40190 9 | flower art | matt+shiny | 250 | S | 51 - 55 | 1 |
| Urban-I 3.0 | 40191 6 | flower art | matt+shiny | 280 | M | 52 - 58 | 1 |
| Urban-I 3.0 | 64214 2 | flower art | matt+shiny | 300 | L | 56 - 61 | 1 |
| Urban-I 3.0 | 86882 5 | core green | matt | 250 | S | 51 - 55 | 1 |
| Urban-I 3.0 | 86883 2 | core green | matt | 280 | M | 52 - 58 | 1 |
| Urban-I 3.0 | 86884 9 | core green | matt | 300 | L | 56 - 61 | 1 |
| Urban-I 3.0 | 86885 6 | core green | matt | 325 | XL | 61 - 65 | 1 |
| Urban-I 3.0 | 86878 8 | core blue | matt | 250 | S | 51 - 55 | 1 |
| Urban-I 3.0 | 86879 5 | core blue | matt | 280 | M | 52 - 58 | 1 |
| Urban-I 3.0 | 86880 1 | core blue | matt | 300 | L | 56 - 61 | 1 |
| Urban-I 3.0 | 86881 8 | core blue | matt | 325 | XL | 61 - 65 | 1 |
| Urban-I 3.0 | 86866 5 | signal yellow | shiny | 250 | S | 51 - 55 | 1 |
| Urban-I 3.0 | 86867 2 | signal yellow | shiny | 280 | M | 52 - 58 | 1 |
| Urban-I 3.0 | 86868 9 | signal yellow | shiny | 300 | L | 56 - 61 | 1 |
| Urban-I 3.0 | 86869 6 | signal yellow | shiny | 325 | XL | 61 - 65 | 1 |
| Urban-I 3.0 | 86874 0 | signal silver | shiny | 250 | S | 51 - 55 | 1 |
| Urban-I 3.0 | 86875 7 | signal silver | shiny | 280 | M | 52 - 58 | 1 |
| Urban-I 3.0 | 86876 4 | signal silver | shiny | 300 | L | 56 - 61 | 1 |
| Urban-I 3.0 | 86877 1 | signal silver | shiny | 325 | XL | 61 - 65 | 1 |
| Urban-I 3.0 | 86870 2 | signal orange | shiny | 250 | S | 51 - 55 | 1 |
| Urban-I 3.0 | 86871 9 | signal orange | shiny | 280 | M | 52 - 58 | 1 |
| Urban-I 3.0 | 86872 6 | signal orange | shiny | 300 | L | 56 - 61 | 1 |
| Urban-I 3.0 | 86873 3 | signal orange | shiny | 325 | XL | 61 - 65 | 1 |
| Urban-I 3.0 MIPS | 89184 7 | velvet black | matt | 270 | S | 51 - 55 | 1 |
| Urban-I 3.0 MIPS | 89183 0 | velvet black | matt | 300 | M | 52 - 58 | 1 |
| Urban-I 3.0 MIPS | 89182 3 | velvet black | matt | 320 | L | 56 - 61 | 1 |
| Urban-I 3.0 MIPS | 89181 6 | velvet black | matt | 345 | XL | 61 - 65 | 1 |
| Urban-I 3.0 MIPS | 89187 8 | titan | matt | 270 | S | 51 - 55 | 1 |
| Urban-I 3.0 MIPS | 89186 1 | titan | matt | 300 | M | 52 - 58 | 1 |
| Urban-I 3.0 MIPS | 89185 4 | titan | matt | 320 | L | 56 - 61 | 1 |
| Urban-I 3.0 MIPS | 89188 5 | titan | matt | 345 | XL | 61 - 65 | 1 |
| Urban-I 3.0 MIPS | 89191 5 | signal yellow | shiny | 270 | S | 51 - 55 | 1 |
| Urban-I 3.0 MIPS | 89190 8 | signal yellow | shiny | 300 | M | 52 - 58 | 1 |
| Urban-I 3.0 MIPS | 89189 2 | signal yellow | shiny | 320 | L | 56 - 61 | 1 |
| Urban-I 3.0 MIPS | 89192 2 | signal yellow | shiny | 345 | XL | 61 - 65 | 1 |

PURL-Y ACE

NEW

VUES



midnight blue



midnight blue



CARACTÉRISTIQUES



Zoom Ace Urban



Boucle



Feu arrière USB magnétique

ACCESSOIRES

- Housse ABUS
- Lumière USB

TECHNOLOGIE



VARIANTES



velvet black



titan



polar white



metallic copper



moss green



champagne gold



iced blue



signal yellow

| Article | EAN 4003318 | Couleur | Finition | Poids g | Taille | Tour de tête cm | Unité emb. |
|------------|----------------|-----------------|------------|---------|--------|-----------------|---------------|
| PURL-Y ACE | 97904 0 | velvet black | matt+shiny | 320 | S | 51 - 55 | 1 |
| PURL-Y ACE | 97905 7 | velvet black | matt+shiny | 340 | M | 54 - 58 | 1 |
| PURL-Y ACE | 97906 4 | velvet black | matt+shiny | 360 | L | 57 - 61 | 1 |
| PURL-Y ACE | 97907 1 | titan | matt+shiny | 320 | S | 51 - 55 | 1 |
| PURL-Y ACE | 97908 8 | titan | matt+shiny | 340 | M | 54 - 58 | 1 |
| PURL-Y ACE | 97909 5 | titan | matt+shiny | 360 | L | 57 - 61 | 1 |
| PURL-Y ACE | 97910 1 | polar white | matt+shiny | 320 | S | 51 - 55 | 1 |
| PURL-Y ACE | 97912 5 | polar white | matt+shiny | 340 | M | 54 - 58 | 1 |
| PURL-Y ACE | 97913 2 | polar white | matt+shiny | 360 | L | 57 - 61 | 1 |
| PURL-Y ACE | 97914 9 | metallic copper | matt+shiny | 320 | S | 51 - 55 | 1 |
| PURL-Y ACE | 97915 6 | metallic copper | matt+shiny | 340 | M | 54 - 58 | 1 |
| PURL-Y ACE | 97916 3 | metallic copper | matt+shiny | 360 | L | 57 - 61 | 1 |
| PURL-Y ACE | 97917 0 | midnight bue | matt+shiny | 320 | S | 51 - 55 | 1 |
| PURL-Y ACE | 97918 7 | midnight bue | matt+shiny | 340 | M | 54 - 58 | 1 |
| PURL-Y ACE | 97919 4 | midnight bue | matt+shiny | 360 | L | 57 - 61 | 1 |
| PURL-Y ACE | 97920 0 | moss green | matt+shiny | 320 | S | 51 - 55 | 1 |
| PURL-Y ACE | 97921 7 | moss green | matt+shiny | 340 | M | 54 - 58 | 1 |
| PURL-Y ACE | 97922 4 | moss green | matt+shiny | 360 | L | 57 - 61 | 1 |
| PURL-Y ACE | 97926 2 | champagne gold | matt+shiny | 320 | S | 51 - 55 | 1 |
| PURL-Y ACE | 97927 9 | champagne gold | matt+shiny | 340 | M | 54 - 58 | 1 |
| PURL-Y ACE | 97928 6 | champagne gold | matt+shiny | 360 | L | 57 - 61 | 1 |
| PURL-Y ACE | 97923 1 | iced blue | matt+shiny | 320 | S | 51 - 55 | 1 |
| PURL-Y ACE | 97924 8 | iced blue | matt+shiny | 340 | M | 54 - 58 | 1 |
| PURL-Y ACE | 97925 5 | iced blue | matt+shiny | 360 | L | 57 - 61 | 1 |
| PURL-Y ACE | 97929 3 | signal yellow | matt+shiny | 320 | S | 51 - 55 | 1 |
| PURL-Y ACE | 97930 9 | signal yellow | matt+shiny | 340 | M | 54 - 58 | 1 |
| PURL-Y ACE | 97931 6 | signal yellow | matt+shiny | 360 | L | 57 - 61 | 1 |

Urban



PURL-Y

VUES



moss green



moss green



CARACTÉRISTIQUES



Zoom Ace



Boucle



Feu arrière USB magnétique (optionnel)

ACCESSOIRES

- Housse ABUS
- Lumière USB HUD-Y/PURL-Y

TECHNOLOGIE



VARIANTES



shiny black



titan



shiny white



metallic copper



midnight blue



champagne gold



iced blue



signal yellow

| Article | EAN 4003318 | Couleur | Finition | Poids g | Taille | Tour de tête cm | Unité emb. |
|---------|----------------|-----------------|----------|---------|--------|-----------------|---------------|
| PURL-Y | 97850 0 | shiny black | shiny | 300 | S | 51 - 55 | 1 |
| PURL-Y | 97878 4 | shiny black | shiny | 320 | M | 54 - 58 | 1 |
| PURL-Y | 97879 1 | shiny black | shiny | 340 | L | 57 - 61 | 1 |
| PURL-Y | 97880 7 | titan | shiny | 300 | S | 51 - 55 | 1 |
| PURL-Y | 97881 4 | titan | shiny | 320 | M | 54 - 58 | 1 |
| PURL-Y | 97882 1 | titan | shiny | 340 | L | 57 - 61 | 1 |
| PURL-Y | 97883 8 | shiny white | shiny | 300 | S | 51 - 55 | 1 |
| PURL-Y | 97884 5 | shiny white | shiny | 320 | M | 54 - 58 | 1 |
| PURL-Y | 97885 2 | shiny white | shiny | 340 | L | 57 - 61 | 1 |
| PURL-Y | 97886 9 | metallic copper | shiny | 300 | S | 51 - 55 | 1 |
| PURL-Y | 97887 6 | metallic copper | shiny | 320 | M | 54 - 58 | 1 |
| PURL-Y | 97888 3 | metallic copper | shiny | 340 | L | 57 - 61 | 1 |
| PURL-Y | 97889 0 | midnight blue | shiny | 300 | S | 51 - 55 | 1 |
| PURL-Y | 97890 6 | midnight blue | shiny | 320 | M | 54 - 58 | 1 |
| PURL-Y | 97891 3 | midnight blue | shiny | 340 | L | 57 - 61 | 1 |
| PURL-Y | 97892 0 | moss green | shiny | 300 | S | 51 - 55 | 1 |
| PURL-Y | 97893 7 | moss green | shiny | 320 | M | 54 - 58 | 1 |
| PURL-Y | 97894 4 | moss green | shiny | 340 | L | 57 - 61 | 1 |
| PURL-Y | 97898 2 | champagne gold | shiny | 300 | S | 51 - 55 | 1 |
| PURL-Y | 97899 9 | champagne gold | shiny | 320 | M | 54 - 58 | 1 |
| PURL-Y | 97900 2 | champagne gold | shiny | 340 | L | 57 - 61 | 1 |
| PURL-Y | 97895 1 | iced blue | shiny | 300 | S | 51 - 55 | 1 |
| PURL-Y | 97896 8 | iced blue | shiny | 320 | M | 54 - 58 | 1 |
| PURL-Y | 97897 5 | iced blue | shiny | 340 | L | 57 - 61 | 1 |
| PURL-Y | 97901 9 | signal yellow | shiny | 300 | S | 51 - 55 | 1 |
| PURL-Y | 97902 6 | signal yellow | shiny | 320 | M | 54 - 58 | 1 |
| PURL-Y | 97903 3 | signal yellow | shiny | 340 | L | 57 - 61 | 1 |

Urban



HYBAN 2.0 LED

VUES



signal black



signal black



CARACTÉRISTIQUES



Zoom Ace Urban



Boucle



USB LED 360

ACCESSOIRES

- Housse ABUS
- Capuche Toplight

TECHNOLOGIE



VARIANTES



signal yellow



signal silver



signal glacier

| Article | EAN 4003318 | Couleur | Finition | Poids g | Taille | Tour de tête cm | Unité emb. |
|---------------|----------------|----------------|----------|---------|--------|-----------------|---------------|
| Hyban 2.0 LED | 61461 3 | signal yellow | shiny | 400 | M | 52 - 58 | 1 |
| Hyban 2.0 LED | 61462 0 | signal yellow | shiny | 455 | L | 56 - 61 | 1 |
| Hyban 2.0 LED | 61463 7 | signal yellow | shiny | 500 | XL | 58 - 63 | 1 |
| Hyban 2.0 LED | 61464 4 | signal silver | shiny | 400 | M | 52 - 58 | 1 |
| Hyban 2.0 LED | 61465 1 | signal silver | shiny | 455 | L | 56 - 61 | 1 |
| Hyban 2.0 LED | 61466 8 | signal silver | shiny | 500 | XL | 58 - 63 | 1 |
| Hyban 2.0 LED | 66711 4 | signal glacier | matt | 400 | M | 52 - 58 | 1 |
| Hyban 2.0 LED | 66712 1 | signal glacier | matt | 455 | L | 56 - 61 | 1 |
| Hyban 2.0 LED | 66713 8 | signal glacier | matt | 500 | XL | 58 - 63 | 1 |
| Hyban 2.0 LED | 61458 3 | signal black | matt | 400 | M | 52 - 58 | 1 |
| Hyban 2.0 LED | 61459 0 | signal black | matt | 455 | L | 56 - 61 | 1 |
| Hyban 2.0 LED | 61460 6 | signal black | matt | 500 | XL | 58 - 63 | 1 |



HYBAN 2.0 ACE

VUES



titan



titan



CARACTÉRISTIQUES



Zoom Ace Urban



Fidlock



LED

ACCESSOIRES

- Housse ABUS
- Visière fumée ou transparente
Pedelec 2.0,
Hyban 2.0, HUD-Y

TECHNOLOGIE



VARIANTES



velvet black



signal yellow



polar white

| Article | EAN 4003318 | Couleur | Finition | Poids g | Taille | Tour de tête cm | Unité emb. |
|------------------------------------------|----------------|---------------|----------|---------|-------------|-----------------|---------------|
| Hyban 2.0 ACE | 86934 1 | velvet black | matt | 470 | M | 52 - 58 | 1 |
| Hyban 2.0 ACE | 86935 8 | velvet black | matt | 510 | L | 56 - 61 | 1 |
| Hyban 2.0 ACE | 86936 5 | velvet black | matt | 560 | XL | 58 - 63 | 1 |
| Hyban 2.0 ACE | 86937 2 | titan | matt | 470 | M | 52 - 58 | 1 |
| Hyban 2.0 ACE | 86938 9 | titan | matt | 510 | L | 56 - 61 | 1 |
| Hyban 2.0 ACE | 86939 6 | titan | matt | 560 | XL | 58 - 63 | 1 |
| Hyban 2.0 ACE | 86940 2 | signal yellow | shiny | 470 | M | 52 - 58 | 1 |
| Hyban 2.0 ACE | 86941 9 | signal yellow | shiny | 510 | L | 56 - 61 | 1 |
| Hyban 2.0 ACE | 86997 6 | polar white | shiny | 470 | M | 52 - 58 | 1 |
| Hyban 2.0 ACE | 86998 3 | polar white | shiny | 510 | L | 56 - 61 | 1 |
| Visière Pedelec 2.0, Hyban 2.0, HUD-Y | 82888 1 | fumée | | | universelle | | 1 |
| Visière Pedelec 2.0, Hyban 2.0, HUD-Y | 82889 8 | transparente | | | universelle | | 1 |



HYBAN 2.0

VUES



chrome silver



chrome silver



CARACTÉRISTIQUES



Zoom Ace Urban



Boucle



LED

ACCESSOIRES

- Housse ABUS
- Lumière LED

TECHNOLOGIE



VARIANTES



velvet black



titan



polar white



living coral



jade green



glacier blue



core green



core blue



chrome rosé



signal orange



signal silver



signal yellow



velvet black



titan



signal yellow

| Article | EAN 4003318 | Couleur | Finition | Poids g | Taille | Tour de tête cm | Unité emb. |
|----------------|----------------|---------------|----------|---------|--------|-----------------|---------------|
| Hyban 2.0 | 86899 3 | velvet black | matt | 400 | M | 52 - 58 | 1 |
| Hyban 2.0 | 86900 6 | velvet black | matt | 460 | L | 56 - 61 | 1 |
| Hyban 2.0 | 86901 3 | velvet black | matt | 500 | XL | 58 - 63 | 1 |
| Hyban 2.0 | 86905 1 | titan | matt | 400 | M | 52 - 58 | 1 |
| Hyban 2.0 | 86906 8 | titan | matt | 460 | L | 56 - 61 | 1 |
| Hyban 2.0 | 86907 5 | titan | matt | 500 | XL | 58 - 63 | 1 |
| Hyban 2.0 | 86902 0 | polar white | shiny | 400 | M | 52 - 58 | 1 |
| Hyban 2.0 | 86903 7 | polar white | shiny | 460 | L | 56 - 61 | 1 |
| Hyban 2.0 | 86904 4 | polar white | shiny | 500 | XL | 58 - 63 | 1 |
| Hyban 2.0 | 86932 7 | living coral | shiny | 400 | M | 52 - 58 | 1 |
| Hyban 2.0 | 86926 6 | jade green | shiny | 400 | M | 52 - 58 | 1 |
| Hyban 2.0 | 86927 3 | jade green | shiny | 460 | L | 56 - 61 | 1 |
| Hyban 2.0 | 86929 7 | glacier blue | shiny | 400 | M | 52 - 58 | 1 |
| Hyban 2.0 | 86930 3 | glacier blue | shiny | 460 | L | 56 - 61 | 1 |
| Hyban 2.0 | 86920 4 | core green | shiny | 400 | M | 52 - 58 | 1 |
| Hyban 2.0 | 86921 1 | core green | shiny | 460 | L | 56 - 61 | 1 |
| Hyban 2.0 | 86917 4 | core blue | shiny | 400 | M | 52 - 58 | 1 |
| Hyban 2.0 | 86918 1 | core blue | shiny | 460 | L | 56 - 61 | 1 |
| Hyban 2.0 | 40184 8 | chrome silver | shiny | 400 | M | 52 - 58 | 1 |
| Hyban 2.0 | 40197 8 | chrome silver | shiny | 460 | L | 56 - 61 | 1 |
| Hyban 2.0 | 40185 5 | chrome rosé | shiny | 400 | M | 52 - 58 | 1 |
| Hyban 2.0 | 86911 2 | signal orange | shiny | 400 | M | 52 - 58 | 1 |
| Hyban 2.0 | 86912 9 | signal orange | shiny | 460 | L | 56 - 61 | 1 |
| Hyban 2.0 | 86914 3 | signal silver | shiny | 400 | M | 52 - 58 | 1 |
| Hyban 2.0 | 86915 0 | signal silver | shiny | 460 | L | 56 - 61 | 1 |
| Hyban 2.0 | 86916 7 | signal silver | shiny | 480 | XL | 58 - 63 | 1 |
| Hyban 2.0 | 86908 2 | signal yellow | shiny | 400 | M | 52 - 58 | 1 |
| Hyban 2.0 | 86909 9 | signal yellow | shiny | 460 | L | 56 - 61 | 1 |
| Hyban 2.0 MIPS | 89200 4 | velvet black | matt | 420 | M | 52 - 58 | 1 |
| Hyban 2.0 MIPS | 89199 1 | velvet black | matt | 480 | L | 56 - 61 | 1 |
| Hyban 2.0 MIPS | 89201 1 | velvet black | matt | 500 | XL | 58 - 63 | 1 |
| Hyban 2.0 MIPS | 89203 5 | titan | matt | 420 | M | 52 - 58 | 1 |
| Hyban 2.0 MIPS | 89202 8 | titan | matt | 480 | L | 56 - 61 | 1 |
| Hyban 2.0 MIPS | 89204 2 | titan | matt | 500 | XL | 58 - 63 | 1 |
| Hyban 2.0 MIPS | 89206 6 | signal yellow | shiny | 420 | M | 52 - 58 | 1 |
| Hyban 2.0 MIPS | 89205 9 | signal yellow | shiny | 480 | L | 56 - 61 | 1 |
| Hyban 2.0 MIPS | 89207 3 | signal yellow | shiny | 500 | XL | 58 - 63 | 1 |

Urban



SKURB ACE

VUES



goldfish orange



goldfish orange



CARACTÉRISTIQUES



Zoom Ace MTB



Boucle



TECHNOLOGIE



VARIANTES



moss green



velvet black



silver white



glacier blue



city vibes

| Article | EAN 4003318 | Couleur | Finition | Poids g | Taille | Tour de tête cm | Unité emb. |
|-----------|----------------|-----------------|------------|---------|--------|-----------------|---------------|
| Skurb Ace | 97963 7 | goldfish orange | shiny | 300 | S | 52 - 56 | 1 |
| Skurb Ace | 97964 4 | goldfish orange | shiny | 310 | M | 55 - 59 | 1 |
| Skurb Ace | 97965 1 | goldfish orange | shiny | 340 | L | 58 - 61 | 1 |
| Skurb Ace | 97967 5 | moss green | shiny | 300 | S | 52 - 56 | 1 |
| Skurb Ace | 97968 2 | moss green | shiny | 310 | M | 55 - 59 | 1 |
| Skurb Ace | 97969 9 | moss green | shiny | 340 | L | 58 - 61 | 1 |
| Skurb ACE | 40385 9 | velvet black | matt+shiny | 310 | S | 52 - 56 | 1 |
| Skurb ACE | 40386 6 | velvet black | matt+shiny | 320 | M | 55 - 59 | 1 |
| Skurb ACE | 40387 3 | velvet black | matt+shiny | 340 | L | 58 - 61 | 1 |
| Skurb ACE | 40394 1 | silver white | matt+shiny | 310 | S | 52 - 56 | 1 |
| Skurb ACE | 40395 8 | silver white | matt+shiny | 320 | M | 55 - 59 | 1 |
| Skurb ACE | 40396 5 | silver white | matt+shiny | 340 | L | 58 - 61 | 1 |
| Skurb ACE | 40388 0 | glacier blue | matt+shiny | 310 | S | 52 - 56 | 1 |
| Skurb ACE | 40389 7 | glacier blue | matt+shiny | 320 | M | 55 - 59 | 1 |
| Skurb ACE | 40390 3 | glacier blue | matt+shiny | 340 | L | 58 - 61 | 1 |
| Skurb ACE | 96455 8 | city vibes | shiny | 300 | S | 52 - 56 | 1 |
| Skurb ACE | 96456 5 | city vibes | shiny | 310 | M | 55 - 59 | 1 |
| Skurb ACE | 96457 2 | city vibes | shiny | 340 | L | 58 - 61 | 1 |



SKURB

NEW

VUES



goldfish orange



goldfish orange



CARACTÉRISTIQUES



Zoom Ace MTB



Boucle

TECHNOLOGIE



VARIANTES



moss green



velvet black



titan



pearl white



midnight blue



velvet black



pearl white



concrete grey

| Article | EAN 4003318 | Couleur | Finition | Poids g | Taille | Tour de tête cm | Unité emb. |
|------------|----------------|-----------------|----------|---------|--------|-----------------|---------------|
| Skurb | 97957 6 | goldfish orange | shiny | 300 | S | 52 - 56 | 1 |
| Skurb | 97958 3 | goldfish orange | shiny | 310 | M | 55 - 59 | 1 |
| Skurb | 97959 0 | goldfish orange | shiny | 340 | L | 58 - 61 | 1 |
| Skurb | 97960 6 | moss green | shiny | 300 | S | 52 - 56 | 1 |
| Skurb | 97961 3 | moss green | shiny | 310 | M | 55 - 59 | 1 |
| Skurb | 97962 0 | moss green | shiny | 340 | L | 58 - 61 | 1 |
| Skurb | 40367 5 | velvet black | matt | 300 | S | 52 - 56 | 1 |
| Skurb | 40368 2 | velvet black | matt | 310 | M | 55 - 59 | 1 |
| Skurb | 40369 9 | velvet black | matt | 340 | L | 58 - 61 | 1 |
| Skurb | 40370 5 | titan | matt | 300 | S | 52 - 56 | 1 |
| Skurb | 40371 2 | titan | matt | 310 | M | 55 - 59 | 1 |
| Skurb | 40372 9 | titan | matt | 340 | L | 58 - 61 | 1 |
| Skurb | 40373 6 | pearl white | shiny | 300 | S | 52 - 56 | 1 |
| Skurb | 40374 3 | pearl white | shiny | 310 | M | 55 - 59 | 1 |
| Skurb | 40375 0 | pearl white | shiny | 340 | L | 58 - 61 | 1 |
| Skurb | 40376 7 | midnight blue | shiny | 300 | S | 52 - 56 | 1 |
| Skurb | 40377 4 | midnight blue | shiny | 310 | M | 55 - 59 | 1 |
| Skurb | 40378 1 | midnight blue | shiny | 340 | L | 58 - 61 | 1 |
| Skurb MIPS | 40627 0 | velvet black | matt | 360 | S | 52 - 56 | 1 |
| Skurb MIPS | 40628 7 | velvet black | matt | 380 | M | 55 - 59 | 1 |
| Skurb MIPS | 40629 4 | velvet black | matt | 410 | L | 58 - 61 | 1 |
| Skurb MIPS | 40624 9 | polar white | matt | 360 | S | 52 - 56 | 1 |
| Skurb MIPS | 40625 6 | polar white | matt | 380 | M | 55 - 59 | 1 |
| Skurb MIPS | 40626 3 | polar white | matt | 410 | L | 58 - 61 | 1 |
| Skurb MIPS | 40630 0 | concrete grey | matt | 360 | S | 52 - 56 | 1 |
| Skurb MIPS | 40631 7 | concrete grey | matt | 380 | M | 55 - 59 | 1 |
| Skurb MIPS | 40632 4 | concrete grey | matt | 410 | L | 58 - 61 | 1 |

Urban



SCRAPER 3.0 ACE

VUES



ultra blue



ultra blue



CARACTÉRISTIQUES



Zoom Ace Urban



Boucle

ACCESSOIRES

- Housse ABUS
- Scrapper 3.0 kit hiver

TECHNOLOGIE



VARIANTES



velvet black



concrete grey

| Article | EAN 4003318 | Couleur | Finition | Poids g | Taille | Tour de tête cm | Unité emb. |
|-----------------|----------------|---------------|----------|---------|--------|-----------------|---------------|
| Scraper 3.0 ACE | 81770 0 | velvet black | matt | 460 | M | 54 - 58 | 1 |
| Scraper 3.0 ACE | 81771 7 | velvet black | matt | 510 | L | 57 - 61 | 1 |
| Scraper 3.0 ACE | 81774 8 | ultra blue | matt | 460 | M | 54 - 58 | 1 |
| Scraper 3.0 ACE | 81775 5 | ultra blue | matt | 510 | L | 57 - 61 | 1 |
| Scraper 3.0 ACE | 81772 4 | concrete grey | matt | 460 | M | 54 - 58 | 1 |
| Scraper 3.0 ACE | 81773 1 | concrete grey | matt | 510 | L | 57 - 61 | 1 |



SCRAPER 3.0

VUES



velvet black



velvet black



CARACTÉRISTIQUES



Zoom Ace Urban



Boucle

ACCESSOIRES

- Housse ABUS
- Scraper 3.0 kit hiver

TECHNOLOGIE



VARIANTES



concrete grey



ultra blue



signal orange



polar matt

| Article | EAN 4003318 | Couleur | Finition | Poids g | Taille | Tour de tête cm | Unité emb. |
|-------------|----------------|---------------|----------|---------|--------|-----------------|---------------|
| Scraper 3.0 | 81758 8 | velvet black | matt | 450 | M | 54 - 58 | 1 |
| Scraper 3.0 | 81759 5 | velvet black | matt | 490 | L | 57 - 62 | 1 |
| Scraper 3.0 | 81760 1 | concrete grey | matt | 450 | M | 54 - 58 | 1 |
| Scraper 3.0 | 81761 8 | concrete grey | matt | 490 | L | 57 - 62 | 1 |
| Scraper 3.0 | 81762 5 | ultra blue | matt | 450 | M | 54 - 58 | 1 |
| Scraper 3.0 | 81763 2 | ultra blue | matt | 490 | L | 57 - 62 | 1 |
| Scraper 3.0 | 81766 3 | signal orange | matt | 450 | M | 54 - 58 | 1 |
| Scraper 3.0 | 81767 0 | signal orange | matt | 490 | L | 57 - 62 | 1 |
| Scraper 3.0 | 81768 7 | polar matt | matt | 450 | M | 54 - 58 | 1 |
| Scraper 3.0 | 81769 4 | polar matt | matt | 490 | L | 57 - 62 | 1 |



ADURO 3.0

VUES



purple waves



purple waves



CARACTÉRISTIQUES



Zoom Ace



Boucle



Lumière USB
(optionnel)

ACCESSOIRES

- Housse ABUS
- Lumière USB Aduro 3.0

TECHNOLOGIE



VARIANTES



velvet black



polar white



midnight blue



titan



race black



glacier blue



blaze red



race grey



maori blackberry



white art



orange palm



signal yellow

| Article | EAN 4003318 | Couleur | Finition | Poids g | Taille | Tour de tête cm | Unité emb. |
|-----------|----------------|------------------|----------|---------|--------|-----------------|---------------|
| Aduro 3.0 | 90127 0 | velvet black | matt | 280 | S | 51 - 55 | 1 |
| Aduro 3.0 | 90325 0 | velvet black | matt | 300 | M | 52 - 58 | 1 |
| Aduro 3.0 | 90346 5 | velvet black | matt | 320 | L | 58 - 62 | 1 |
| Aduro 3.0 | 90493 6 | polar white | matt | 280 | S | 51 - 55 | 1 |
| Aduro 3.0 | 90628 2 | polar white | matt | 300 | M | 52 - 58 | 1 |
| Aduro 3.0 | 90793 7 | polar white | matt | 320 | L | 58 - 62 | 1 |
| Aduro 3.0 | 91265 8 | midnight blue | shiny | 280 | S | 51 - 55 | 1 |
| Aduro 3.0 | 91268 9 | midnight blue | shiny | 300 | M | 52 - 58 | 1 |
| Aduro 3.0 | 91269 6 | midnight blue | shiny | 320 | L | 58 - 62 | 1 |
| Aduro 3.0 | 91270 2 | titan | matt | 280 | S | 51 - 55 | 1 |
| Aduro 3.0 | 91273 3 | titan | matt | 300 | M | 52 - 58 | 1 |
| Aduro 3.0 | 91277 1 | titan | matt | 320 | L | 58 - 62 | 1 |
| Aduro 3.0 | 91280 1 | race black | matt | 280 | S | 51 - 55 | 1 |
| Aduro 3.0 | 91281 8 | race black | matt | 300 | M | 52 - 58 | 1 |
| Aduro 3.0 | 91282 5 | race black | matt | 320 | L | 58 - 62 | 1 |
| Aduro 3.0 | 91285 6 | glacier blue | shiny | 280 | S | 51 - 55 | 1 |
| Aduro 3.0 | 91311 2 | glacier blue | shiny | 300 | M | 52 - 58 | 1 |
| Aduro 3.0 | 91380 8 | glacier blue | shiny | 320 | L | 58 - 62 | 1 |
| Aduro 3.0 | 91381 5 | blaze red | shiny | 280 | S | 51 - 55 | 1 |
| Aduro 3.0 | 91528 4 | blaze red | shiny | 300 | M | 52 - 58 | 1 |
| Aduro 3.0 | 91715 8 | blaze red | shiny | 320 | L | 58 - 62 | 1 |
| Aduro 3.0 | 91732 5 | race grey | matt | 280 | S | 51 - 55 | 1 |
| Aduro 3.0 | 91733 2 | race grey | matt | 300 | M | 52 - 58 | 1 |
| Aduro 3.0 | 91734 9 | race grey | matt | 320 | L | 58 - 62 | 1 |
| Aduro 3.0 | 91735 6 | maori blackberry | matt | 280 | S | 51 - 55 | 1 |
| Aduro 3.0 | 91736 3 | maori blackberry | matt | 300 | M | 52 - 58 | 1 |
| Aduro 3.0 | 91737 0 | maori blackberry | matt | 320 | L | 58 - 62 | 1 |
| Aduro 3.0 | 91738 7 | white art | shiny | 280 | S | 51 - 55 | 1 |
| Aduro 3.0 | 91739 4 | white art | shiny | 300 | M | 52 - 58 | 1 |
| Aduro 3.0 | 91740 0 | white art | shiny | 320 | L | 58 - 62 | 1 |
| Aduro 3.0 | 02033 9 | orange palm | shiny | 280 | S | 51 - 55 | 1 |
| Aduro 3.0 | 02044 5 | orange palm | shiny | 300 | M | 52 - 58 | 1 |
| Aduro 3.0 | 02095 7 | orange palm | shiny | 320 | L | 58 - 62 | 1 |
| Aduro 3.0 | 02098 8 | purple waves | shiny | 280 | S | 51 - 55 | 1 |
| Aduro 3.0 | 02122 0 | purple waves | shiny | 300 | M | 52 - 58 | 1 |
| Aduro 3.0 | 02123 7 | purple waves | shiny | 320 | L | 58 - 62 | 1 |
| Aduro 3.0 | 02549 5 | signal yellow | shiny | 280 | S | 51 - 55 | 1 |
| Aduro 3.0 | 02794 9 | signal yellow | shiny | 300 | M | 52 - 58 | 1 |
| Aduro 3.0 | 02850 2 | signal yellow | shiny | 320 | L | 58 - 62 | 1 |

Urban



ENFANTS



YOUDROP FF



Ti silver

Page 242



moss green

Page 242



sage green

Page 242



velvet black

Page 242



midnight blue

Page 242



chalk grey

Page 242

YOUDROP



moss green

Page 244



Ti silver

Page 244



shiny black

Page 244



icon yellow

Page 244



sage green

Page 244



wildberry red

Page 244

YOUN-I 2.0



cool grey

Page 246



velvet black

Page 246



street art

Page 246



sparkling titan

Page 246



sparkling pink

Page 246



sparkling green

Page 246



sparkling blue

Page 246



signal yellow

Page 246



polar white

Page 246



living coral

Page 246



grey star

Page 246



grey flash

Page 246



glacier blue

Page 246



flower art

Page 246



cherry heart

Page 246



blue anchor

Page 246



blaze red

Page 246



black violett

Page 246



rose gold

Page 246



midnight blue

Page 246



iced mint

Page 246

YOUN-I MIPS



Mips

velvet black

Page 248



Mips

sparkling green

Page 248



Mips

polar matt

Page 248

SKURB KID



blue sailor

Page 250



green jungle

Page 250



rose foxes

Page 250



shiny pink

Page 250



shiny green

Page 250



shiny red

Page 250



midnight blue

Page 250



goldfish orange

Page 250



shiny black

Page 250



cream summer

Page 250



white crowns

Page 250



grey stars

Page 250

SMILEY 3.0 ACE LED



velvet black

Page 252



shiny white

Page 252



shiny grey

Page 252



royal purple

Page 252



royal green

Page 252



royal blue

Page 252

SMILEY 3.0 LED



blue car

Page 254



rose strawberry

Page 254



grey space

Page 254



blue rainbow

Page 254

SMILEY 3.0



pink butterfly

Page 256



shiny yellow

Page 256



shiny red

Page 256



shiny pink

Page 256



shiny orange

Page 256



shiny green

Page 256



shiny blue

Page 256



rose princess

Page 256



purple star

Page 256



orange monster

Page 256



grey police

Page 256



grey horse

Page 256



green robo

Page 256



green nordic

Page 256



blue whale

Page 256



blue croco

Page 256

SMOOTY 2.0



blue space

Page 258



white smiley

Page 258



pink watermelon

Page 258



purple kisses

Page 258

YOUDROP FF

VUES



Ti silver



Ti silver



CARACTÉRISTIQUES



Zoom Ace YouDrop



Visière velcro



Mentonnière amovible



Réfecteur

TECHNOLOGIE



VARIANTES



moss green



sage green



velvet black



midnight blue



chalk grey

| Article | EAN 4003318 | Couleur | Finition | Poids g | Taille | Tour de tête cm | VE |
|------------|----------------|---------------|----------|---------|--------|-----------------|----|
| YouDrop FF | 98089 3 | Ti silver | matt | 440 | S | 48 - 55 | 1 |
| YouDrop FF | 98090 9 | moss green | matt | 440 | S | 48 - 55 | 1 |
| YouDrop FF | 03421 3 | sage green | matt | 430 | S | 48 - 55 | 1 |
| YouDrop FF | 03419 0 | velvet black | matt | 440 | S | 48 - 55 | 1 |
| YouDrop FF | 03420 6 | midnight blue | matt | 430 | S | 48 - 55 | 1 |
| YouDrop FF | 03422 0 | chalk grey | matt | 430 | S | 48 - 55 | 1 |



YOUDROP

VUES



moss green



moss green



CARACTÉRISTIQUES



Zoom Ace YouDrop



Réflecteur



Visière velcro

ACCESSOIRES

- Housse ABUS



TECHNOLOGIE



VARIANTES



Ti silver



shiny black



icon yellow



sage green



wildberry red

| Article | EAN 4003318 | Couleur | Finition | Poids g | Taille | Tour de tête cm | VE |
|---------|----------------|---------------|----------|---------|--------|-----------------|----|
| YouDrop | 98087 9 | Ti silver | shiny | 310 | S | 48 - 55 | 1 |
| YouDrop | 98088 6 | moss green | shiny | 310 | S | 48 - 55 | 1 |
| YouDrop | 03423 7 | shiny black | shiny | 310 | S | 48 - 55 | 1 |
| YouDrop | 03426 8 | icon yellow | shiny | 310 | S | 48 - 55 | 1 |
| YouDrop | 03431 2 | sage green | shiny | 310 | S | 48 - 55 | 1 |
| YouDrop | 03425 1 | wildberry red | shiny | 310 | S | 48 - 55 | 1 |



YOUN-I 2.0

VUES



cool grey



cool grey



CARACTÉRISTIQUES



Zoom Ace Urban



Boucle



LED

ACCESSOIRES

- Housse ABUS
- Lumière USB
URBAN-I 3.0/HYBAN
2.0/YOUN-I 2.0



Vainqueur du
test de Stiftung
Warentest

TECHNOLOGIE



VARIANTES



velvet black



street art



sparkling titan



sparkling pink



sparkling green



sparkling blue



signal yellow



pearl white



living coral



grey star



grey flash



glacier blue



flower art



cherry heart



blue anchor



blaze red



black violet



rose gold



midnight blue



iced mint

| Article | EAN 4003318 | Couleur | Finition | Poids g | Taille | Tour de tête cm | VE |
|------------|----------------|-----------------|------------|---------|--------|-----------------|----|
| Youn-l 2.0 | 40150 3 | velvet black | matt | 240 | S | 48 - 54 | 1 |
| Youn-l 2.0 | 40151 0 | velvet black | matt | 260 | M | 52 - 57 | 1 |
| Youn-l 2.0 | 67047 3 | street art | matt+shiny | 240 | S | 48 - 54 | 1 |
| Youn-l 2.0 | 67048 0 | street art | matt+shiny | 260 | M | 52 - 57 | 1 |
| Youn-l 2.0 | 40170 1 | sparkling titan | shiny | 240 | S | 48 - 54 | 1 |
| Youn-l 2.0 | 40171 8 | sparkling titan | shiny | 260 | M | 52 - 57 | 1 |
| Youn-l 2.0 | 40164 0 | sparkling pink | shiny | 240 | S | 48 - 54 | 1 |
| Youn-l 2.0 | 40165 7 | sparkling pink | shiny | 260 | M | 52 - 57 | 1 |
| Youn-l 2.0 | 40160 2 | sparkling green | shiny | 240 | S | 48 - 54 | 1 |
| Youn-l 2.0 | 40161 9 | sparkling green | shiny | 260 | M | 52 - 57 | 1 |
| Youn-l 2.0 | 40158 9 | sparkling blue | shiny | 240 | S | 48 - 54 | 1 |
| Youn-l 2.0 | 40159 6 | sparkling blue | shiny | 260 | M | 52 - 57 | 1 |
| Youn-l 2.0 | 40162 6 | signal yellow | shiny | 240 | S | 48 - 54 | 1 |
| Youn-l 2.0 | 40163 3 | signal yellow | shiny | 260 | M | 52 - 57 | 1 |
| Youn-l 2.0 | 40152 7 | pearl white | shiny | 240 | S | 48 - 54 | 1 |
| Youn-l 2.0 | 40153 4 | pearl white | shiny | 260 | M | 52 - 57 | 1 |
| Youn-l 2.0 | 40156 5 | living coral | shiny | 240 | S | 48 - 54 | 1 |
| Youn-l 2.0 | 40157 2 | living coral | shiny | 260 | M | 52 - 57 | 1 |
| Youn-l 2.0 | 63810 7 | grey star | matt+shiny | 240 | S | 48 - 54 | 1 |
| Youn-l 2.0 | 63811 4 | grey star | matt+shiny | 260 | M | 52 - 57 | 1 |
| Youn-l 2.0 | 91890 2 | cool grey | matt | 240 | S | 48 - 54 | 1 |
| Youn-l 2.0 | 91891 9 | cool grey | matt | 260 | M | 52 - 57 | 1 |
| Youn-l 2.0 | 63812 1 | grey flash | matt+shiny | 240 | S | 48 - 54 | 1 |
| Youn-l 2.0 | 63813 8 | grey flash | matt+shiny | 260 | M | 52 - 57 | 1 |
| Youn-l 2.0 | 40154 1 | glacier blue | shiny | 240 | S | 48 - 54 | 1 |
| Youn-l 2.0 | 40155 8 | glacier blue | shiny | 260 | M | 52 - 57 | 1 |
| Youn-l 2.0 | 67045 9 | flower art | matt+shiny | 240 | S | 48 - 54 | 1 |
| Youn-l 2.0 | 67046 6 | flower art | matt+shiny | 260 | M | 52 - 57 | 1 |
| Youn-l 2.0 | 63808 4 | cherry heart | matt+shiny | 240 | S | 48 - 54 | 1 |
| Youn-l 2.0 | 63809 1 | cherry heart | matt+shiny | 260 | M | 52 - 57 | 1 |
| Youn-l 2.0 | 63814 5 | blue anchor | matt+shiny | 240 | S | 48 - 54 | 1 |
| Youn-l 2.0 | 63815 2 | blue anchor | matt+shiny | 260 | M | 52 - 57 | 1 |
| Youn-l 2.0 | 40168 8 | blaze red | shiny | 240 | S | 48 - 54 | 1 |
| Youn-l 2.0 | 40169 5 | blaze red | shiny | 260 | M | 52 - 57 | 1 |
| Youn-l 2.0 | 40166 4 | black violet | shiny | 240 | S | 48 - 54 | 1 |
| Youn-l 2.0 | 40167 1 | black violet | shiny | 260 | M | 52 - 57 | 1 |
| Youn-l 2.0 | 91888 9 | rose gold | matt | 240 | S | 48 - 54 | 1 |
| Youn-l 2.0 | 91889 6 | rose gold | matt | 260 | M | 52 - 57 | 1 |
| Youn-l 2.0 | 91885 8 | midnight blue | matt | 240 | S | 48 - 54 | 1 |
| Youn-l 2.0 | 91887 2 | midnight blue | matt | 260 | M | 52 - 57 | 1 |
| Youn-l 2.0 | 91892 6 | iced mint | matt | 240 | S | 48 - 54 | 1 |
| Youn-l 2.0 | 91893 3 | iced mint | matt | 260 | M | 52 - 57 | 1 |



YOUN-I MIPS

VARIANTES



velvet black



velvet black



CARACTÉRISTIQUES



Zoom Evo Kids



Boucle



LED

ACCESSOIRES

- Housse ABUS
- Capuche de pluie Toplight



TECHNOLOGIE



VARIANTES



sparkling green



polar matt

| Article | EAN 4003318 | Couleur | Finition | Poids g | Taille | Tour de tête cm | VE |
|-------------|----------------|-----------------|----------|---------|--------|-----------------|----|
| Youn-I MIPS | 38811 8 | velvet black | matt | 260 | S | 48 - 54 | 1 |
| Youn-I MIPS | 38812 5 | velvet black | matt | 280 | M | 52 - 57 | 1 |
| Youn-I MIPS | 38813 2 | sparkling green | shiny | 260 | S | 48 - 54 | 1 |
| Youn-I MIPS | 38814 9 | sparkling green | shiny | 280 | M | 52 - 57 | 1 |
| Youn-I MIPS | 38809 5 | polar matt | matt | 260 | S | 48 - 54 | 1 |
| Youn-I MIPS | 38810 1 | polar matt | matt | 280 | M | 52 - 57 | 1 |



SKURB KID

NEW

VUES



blue sailor



blue sailor



CARACTÉRISTIQUES



Zoom Evo Kids



Boucle



USB LED

ACCESSOIRES

- Housse ABUS
- Lumière USB Smiley 3.0/ Skurb Kid
- Kit hiver Smiley

TECHNOLOGIE



VARIANTES



| Article | EAN 4003318 | Couleur | Finition | Poids g | Taille | Tour de tête cm | VE |
|-----------|----------------|-----------------|----------|---------|--------|-----------------|----|
| Skurb Kid | 97846 3 | blue sailor | shiny | 240 | S | 45 - 50 | 1 |
| Skurb Kid | 97847 0 | blue sailor | shiny | 250 | M | 50 - 55 | 1 |
| Skurb Kid | 97848 7 | rose foxes | shiny | 240 | S | 45 - 50 | 1 |
| Skurb Kid | 97849 4 | rose foxes | shiny | 250 | M | 50 - 55 | 1 |
| Skurb Kid | 04452 6 | shiny pink | shiny | 240 | S | 45 - 50 | 1 |
| Skurb Kid | 04650 6 | shiny pink | shiny | 250 | M | 50 - 55 | 1 |
| Skurb Kid | 04428 1 | shiny green | shiny | 240 | S | 45 - 50 | 1 |
| Skurb Kid | 04440 3 | shiny green | shiny | 250 | M | 50 - 55 | 1 |
| Skurb Kid | 04300 0 | shiny red | shiny | 240 | S | 45 - 50 | 1 |
| Skurb Kid | 04426 7 | shiny red | shiny | 250 | M | 50 - 55 | 1 |
| Skurb Kid | 04283 6 | midnight blue | shiny | 240 | S | 45 - 50 | 1 |
| Skurb Kid | 04289 8 | midnight blue | shiny | 250 | M | 50 - 55 | 1 |
| Skurb Kid | 04677 3 | goldfish orange | shiny | 240 | S | 45 - 50 | 1 |
| Skurb Kid | 04678 0 | goldfish orange | shiny | 250 | M | 50 - 55 | 1 |
| Skurb Kid | 04296 6 | shiny black | shiny | 240 | S | 45 - 50 | 1 |
| Skurb Kid | 04298 0 | shiny black | shiny | 250 | M | 50 - 55 | 1 |
| Skurb Kid | 04679 7 | cream summer | shiny | 240 | S | 45 - 50 | 1 |
| Skurb Kid | 04680 3 | cream summer | shiny | 250 | M | 50 - 55 | 1 |
| Skurb Kid | 04681 0 | white crowns | shiny | 240 | S | 45 - 50 | 1 |
| Skurb Kid | 04718 3 | white crowns | shiny | 250 | M | 50 - 55 | 1 |
| Skurb Kid | 04744 2 | grey stars | shiny | 240 | S | 45 - 50 | 1 |
| Skurb Kid | 04746 6 | grey stars | shiny | 250 | M | 50 - 55 | 1 |
| Skurb Kid | 04772 5 | green jungle | shiny | 240 | S | 45 - 50 | 1 |
| Skurb Kid | 04774 9 | green jungle | shiny | 250 | M | 50 - 55 | 1 |



SMILEY 3.0 ACE LED

VUES



velvet black



velvet black



CARACTÉRISTIQUES



Zoom Evo Kids



Boucle



USB LED

ACCESSOIRES

- Housse ABUS
- Kit hiver Smiley

TECHNOLOGIE



VARIANTES



shiny white



shiny grey



royal purple



royal green



royal blue

| Article | EAN 4003318 | Couleur | Finition | Poids g | Taille | Tour de tête cm | VE |
|--------------------|----------------|--------------|----------|---------|--------|-----------------|----|
| Smiley 3.0 ACE LED | 67714 4 | shiny white | shiny | 230 | S | 45 - 50 | 1 |
| Smiley 3.0 ACE LED | 67715 1 | shiny white | shiny | 250 | M | 50 - 55 | 1 |
| Smiley 3.0 ACE LED | 67716 8 | shiny grey | shiny | 230 | S | 45 - 50 | 1 |
| Smiley 3.0 ACE LED | 67717 5 | shiny grey | shiny | 250 | M | 50 - 55 | 1 |
| Smiley 3.0 ACE LED | 67712 0 | royal purple | shiny | 230 | S | 45 - 50 | 1 |
| Smiley 3.0 ACE LED | 67713 7 | royal purple | shiny | 250 | M | 50 - 55 | 1 |
| Smiley 3.0 ACE LED | 67710 6 | royal green | shiny | 230 | S | 45 - 50 | 1 |
| Smiley 3.0 ACE LED | 67711 3 | royal green | shiny | 250 | M | 50 - 55 | 1 |
| Smiley 3.0 ACE LED | 67708 3 | royal blue | shiny | 230 | S | 45 - 50 | 1 |
| Smiley 3.0 ACE LED | 67709 0 | royal blue | shiny | 250 | M | 50 - 55 | 1 |
| Smiley 3.0 ACE LED | 66228 7 | velvet black | matt | 230 | S | 45 - 50 | 1 |
| Smiley 3.0 ACE LED | 66239 3 | velvet black | matt | 250 | M | 50 - 55 | 1 |



SMILEY 3.0 LED

VUES



blue car



blue car



CARACTÉRISTIQUES



Zoom Evo Kids



Boucle



Lumière USB magnétique

ACCESSOIRES

- Housse ABUS
- Lumière USB Smiley 3.0/ Skurb Kid
- Kit hiver Smiley

TECHNOLOGIE



VARIANTES



rose strawberry



grey space



blue rainbow

| Article | EAN 4003318 | Couleur | Finition | Poids g | Taille | Tour de tête cm | VE |
|----------------|----------------|-----------------|----------|---------|--------|-----------------|----|
| Smiley 3.0 LED | 67706 9 | rose strawberry | shiny | 230 | S | 45 - 50 | 1 |
| Smiley 3.0 LED | 67707 6 | rose strawberry | shiny | 250 | M | 50 - 55 | 1 |
| Smiley 3.0 LED | 67298 9 | grey space | shiny | 230 | S | 45 - 50 | 1 |
| Smiley 3.0 LED | 67299 6 | grey space | shiny | 250 | M | 50 - 55 | 1 |
| Smiley 3.0 LED | 67300 9 | blue rainbow | shiny | 230 | S | 45 - 50 | 1 |
| Smiley 3.0 LED | 67301 6 | blue rainbow | shiny | 250 | M | 50 - 55 | 1 |
| Smiley 3.0 LED | 67296 5 | blue car | shiny | 230 | S | 45 - 50 | 1 |
| Smiley 3.0 LED | 67297 2 | blue car | shiny | 250 | M | 50 - 55 | 1 |



SMILEY 3.0

VUES



pink butterfly



pink butterfly



CARACTÉRISTIQUES



Zoom Evo Kids



Boucle

ACCESSOIRES

- Housse ABUS
- Lumière USB Smiley 3.0/ Skurb Kid
- Kit hiver Smiley

TECHNOLOGIE



VARIANTES



shiny yellow



shiny red



shiny pink



shiny orange



shiny green



shiny blue



rose princess



purple star



orange monster



grey police



grey horse



green robo



green nordic



blue whale



blue croco

| Article | EAN 4003318 | Couleur | Finition | Poids g | Taille | Tour de tête cm | VE |
|------------|----------------|----------------|----------|---------|--------|-----------------|----|
| Smiley 3.0 | 67277 4 | shiny yellow | shiny | 220 | S | 45 - 50 | 1 |
| Smiley 3.0 | 67278 1 | shiny yellow | shiny | 240 | M | 50 - 55 | 1 |
| Smiley 3.0 | 67273 6 | shiny red | shiny | 220 | S | 45 - 50 | 1 |
| Smiley 3.0 | 67274 3 | shiny red | shiny | 240 | M | 50 - 55 | 1 |
| Smiley 3.0 | 67271 2 | shiny pink | shiny | 220 | S | 45 - 50 | 1 |
| Smiley 3.0 | 67272 9 | shiny pink | shiny | 240 | M | 50 - 55 | 1 |
| Smiley 3.0 | 67275 0 | shiny orange | shiny | 220 | S | 45 - 50 | 1 |
| Smiley 3.0 | 67276 7 | shiny orange | shiny | 240 | M | 50 - 55 | 1 |
| Smiley 3.0 | 67279 8 | shiny green | shiny | 220 | S | 45 - 50 | 1 |
| Smiley 3.0 | 67280 4 | shiny green | shiny | 240 | M | 50 - 55 | 1 |
| Smiley 3.0 | 67294 1 | shiny blue | shiny | 220 | S | 45 - 50 | 1 |
| Smiley 3.0 | 67295 8 | shiny blue | shiny | 240 | M | 50 - 55 | 1 |
| Smiley 3.0 | 67250 7 | rose princess | shiny | 220 | S | 45 - 50 | 1 |
| Smiley 3.0 | 67251 4 | rose princess | shiny | 240 | M | 50 - 55 | 1 |
| Smiley 3.0 | 67259 0 | purple star | shiny | 220 | S | 45 - 50 | 1 |
| Smiley 3.0 | 67260 6 | purple star | shiny | 240 | M | 50 - 55 | 1 |
| Smiley 3.0 | 67257 6 | pink butterfly | shiny | 220 | S | 45 - 50 | 1 |
| Smiley 3.0 | 67258 3 | pink butterfly | shiny | 240 | M | 50 - 55 | 1 |
| Smiley 3.0 | 67265 1 | orange monster | shiny | 220 | S | 45 - 50 | 1 |
| Smiley 3.0 | 67266 8 | orange monster | shiny | 240 | M | 50 - 55 | 1 |
| Smiley 3.0 | 67269 9 | grey police | shiny | 220 | S | 45 - 50 | 1 |
| Smiley 3.0 | 67270 5 | grey police | shiny | 240 | M | 50 - 55 | 1 |
| Smiley 3.0 | 67252 1 | grey horse | shiny | 220 | S | 45 - 50 | 1 |
| Smiley 3.0 | 67253 8 | grey horse | shiny | 240 | M | 50 - 55 | 1 |
| Smiley 3.0 | 67267 5 | green robo | shiny | 220 | S | 45 - 50 | 1 |
| Smiley 3.0 | 67268 2 | green robo | shiny | 240 | M | 50 - 55 | 1 |
| Smiley 3.0 | 67255 2 | green nordic | shiny | 220 | S | 45 - 50 | 1 |
| Smiley 3.0 | 67256 9 | green nordic | shiny | 240 | M | 50 - 55 | 1 |
| Smiley 3.0 | 67261 3 | blue whale | shiny | 220 | S | 45 - 50 | 1 |
| Smiley 3.0 | 67262 0 | blue whale | shiny | 240 | M | 50 - 55 | 1 |
| Smiley 3.0 | 67263 7 | blue croco | shiny | 220 | S | 45 - 50 | 1 |
| Smiley 3.0 | 67264 4 | blue croco | shiny | 240 | M | 50 - 55 | 1 |



SMOOTY 2.0

VUES



blue space



blue space



CARACTÉRISTIQUES



Zoom Evo Kids



Boucle

ACCESSOIRES

- Housse ABUS

TECHNOLOGIE



VARIANTES



white smiley



pink watermelon



purple kisses

| Article | EAN 4003318 | Couleur | Finition | Poids g | Taille | Tour de tête cm | VE |
|------------|----------------|-----------------|----------|---------|--------|-----------------|----|
| Smooty 2.0 | 81623 9 | blue space | shiny | 200 | S | 45 - 50 | 1 |
| Smooty 2.0 | 81851 6 | blue space | shiny | 220 | M | 50 - 55 | 1 |
| Smooty 2.0 | 81852 3 | white smiley | shiny | 200 | S | 45 - 50 | 1 |
| Smooty 2.0 | 81853 0 | white smiley | shiny | 220 | M | 50 - 55 | 1 |
| Smooty 2.0 | 81854 7 | pink watermelon | shiny | 200 | S | 45 - 50 | 1 |
| Smooty 2.0 | 81855 4 | pink watermelon | shiny | 220 | M | 50 - 55 | 1 |
| Smooty 2.0 | 81856 1 | purple kisses | shiny | 200 | S | 45 - 50 | 1 |
| Smooty 2.0 | 81857 8 | purple kisses | shiny | 220 | M | 50 - 55 | 1 |



ACCESSOIRES DE CASQUE



**SCRAPER 3.0
KIT HIVER**



Page 262

**PEDELEC 2.0
KIT HIVER**



Page 262

KIT HIVER



Page 262

CASQUETTE



Page 263

CAPUCHE



Page 263

CAPUCHE TOPLIGHT



Page 263

VISIÈRE



Gamechanger
TT & TRI
Page 264

VISIÈRE



Hyban+
Page 264

VISIÈRE



Pedelec 2.0, Hyban
2.0, Hud-Y Ace
Page 264

VISIÈRE



Buteo
Page 265

LUMIÈRE USB



Hud-Y
Page 265

LUMIÈRE USB



Smiley 3.0,
Skurb Kid
Page 265

LUMIÈRE USB



Urban-I 3.0, Hyban
2.0, Youn-I 2.0
Page 266

LUMIÈRE USB



Aduro 3.0
Page 266

**PAD FRESH MS
SPRAY NETTOYANT**



Page 266

CAPTEUR QUIN



Page 267

HOUSSE ABUS



Page 267

**HOUSSE DE CASQUE
PREMIUM**



Page 267

**SET AUTOCOLLANTS
RÉFLECTEURS**

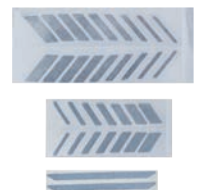

Urban-I 3.0,
Hyban 2.0
Page 267

KIT HIVER SCRAPER 3.0



Kit d'hiver comprenant des oreillettes, un cache-vent et un bonnet en polaire

DONNÉES TECHNIQUES

- Bonnet molletonné avec protection des oreilles, qui remplace les mousses de protection habituelles dans le casque et protège du froid
- Cache-oreilles supplémentaire qui peut être attaché au casque

| Article | 4003318 | Couleur | Taille | Unité emb. |
|-----------------------|---------|---------------|--------|------------|
| KIT HIVER SCRAPER 3.0 | 81804 2 | velvet noir | M | 1 |
| KIT HIVER SCRAPER 3.0 | 81805 9 | velvet noir | L | 1 |
| KIT HIVER SCRAPER 3.0 | 81806 6 | polar matt | M | 1 |
| KIT HIVER SCRAPER 3.0 | 81807 3 | polar matt | L | 1 |
| KIT HIVER SCRAPER 3.0 | 81808 0 | ultra blue | M | 1 |
| KIT HIVER SCRAPER 3.0 | 81809 7 | ultra blue | L | 1 |
| KIT HIVER SCRAPER 3.0 | 81810 3 | signal orange | M | 1 |
| KIT HIVER SCRAPER 3.0 | 81811 0 | signal orange | L | 1 |

KIT HIVER PEDELEC 2.0



DONNÉES TECHNIQUES

- Cache-oreilles supplémentaire qui peut être attaché au casque

| Article | 4003318 | Couleur | Taille | Unité emb. |
|-----------------------|---------|---------|-------------|------------|
| Kit hiver Pedelec 2.0 | 83482 0 | noir | universelle | 1 |

KIT HIVER



DONNÉES TECHNIQUES

- Bonnet en fibres non tissées, très confortables, équipé de protections d'oreilles
- Coutures soudées pour plus de confort

| Article | 4003318 | Couleur | Taille | Unité emb. |
|-----------------------|---------|---------|--------|------------|
| Kit hiver | 48876 4 | noir | M | 1 |
| Kit hiver | 48877 1 | noir | L | 1 |
| Kit hiver pour Smiley | 48874 0 | noir | S | 1 |
| Kit hiver pour Smiley | 48875 7 | noir | M | 1 |

CASQUETTE



autumn noir

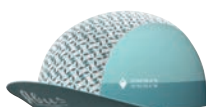

porto blue



italian white



adventure blue

DONNÉES TECHNIQUES

- 100 % fabriquée en Italie
- Grand bandeau antibactérien de 20mm de largeur
- Bandeau élastique pour un ajustement optimal
- Tissu mixte à séchage rapide composé de 65 % de polyester et de 35 % de coton
- Lavable à 30 degrés, ne convient pas au sèche-linge
- Partie centrale de la casquette en mailles de filet 100% polyester
- Casquette de course à porter sous le casque de vélo de course, sert de protection contre le soleil et la transpiration

| Article | 4003318 | Couleur | Taille | Tour de tête cm | Unité emb. |
|-----------|---------|----------------|--------|-----------------|------------|
| Casquette | 96907 2 | autumn noir | S | 51 - 55 | 1 |
| Casquette | 96047 5 | autumn noir | M/L | 56 - 61 | 1 |
| Casquette | 96909 6 | porto blue | S | 51 - 55 | 1 |
| Casquette | 96048 2 | porto blue | M/L | 56 - 61 | 1 |
| Casquette | 96908 9 | italian white | S | 51 - 55 | 1 |
| Casquette | 96049 9 | italian white | M/L | 56 - 61 | 1 |
| Casquette | 96906 5 | adventure blue | S | 51 - 55 | 1 |
| Casquette | 96046 8 | adventure blue | M/L | 56 - 61 | 1 |

CAPUCHE



DONNÉES TECHNIQUES

- Equipée d'un élastique pour un parfait ajustage de la capuche à la taille du casque
- Capuche universelle Forme optimisée pour la plupart des casques, notamment ceux équipés d'une visière

| Article | 4003318 | Couleur | Taille | Unité emb. |
|---------|---------|---------|-------------|------------|
| Capuche | 52151 5 | jaune | universelle | 1 |
| Capuche | 52154 6 | noir | universelle | 1 |

CAPUCHE TOPLIGHT

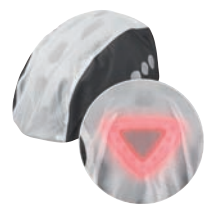

DONNÉES TECHNIQUES

- Matériau imperméable de couleur vive pour être visible par très mauvais temps et lorsque les conditions sont mauvaises
- Equipée d'un élastique pour un parfait ajustage de la capuche à la taille du casque
- La capuche Toplight s'adapte sur tous les casques avec une lumière LED sur le haut
- Grâce à son tissu transparent, la lumière LED reste bien visible

| Article | 4003318 | Couleur | Taille | Unité emb. |
|------------------|---------|---------|-------------|------------|
| Capuche Toplight | 39849 0 | noir | universelle | 1 |

VISIÈRE GAMECHANGER TT/TRI



transparente

Fumée

chrome

DONNÉES TECHNIQUES

- Visière anti-buée grâce à une bonne ventilation, pour une vue toujours dégagée
- Les aimants dans le casque et sur le haut de la visière permettent un maintien ferme
- La grande visière permet une vision claire et dégagée vers l'avant
- Visière disponible en trois versions
- Le design et la conception de la visière font qu'elle s'intègre parfaitement dans le casque pour améliorer encore l'aérodynamisme

| Article | 4003318 | Couleur | Taille | Unité emb. |
|----------------------|---------|--------------|--------|------------|
| Visière transparente | 67936 0 | transparente | S | 1 |
| Visière transparente | 67937 7 | transparente | M | 1 |
| Visière transparente | 67938 4 | transparente | L | 1 |
| Visière fumée | 67939 1 | fumée | S | 1 |
| Visière fumée | 67940 7 | fumée | M | 1 |
| Visière fumée | 67941 4 | fumée | L | 1 |
| Visière chrome | 67942 1 | chrome | S | 1 |
| Visière chrome | 67943 8 | chrome | M | 1 |
| Visière chrome | 67944 5 | chrome | L | 1 |

VISIÈRE HYBAN+



| Article | 4003318 | Couleur | Taille | Unité emb. |
|-------------------------------|---------|--------------|-------------|------------|
| Visière Hyban+ | 76435 6 | fumée | universelle | 1 |
| Visière Hyban+ | 76436 3 | transparente | universelle | 1 |
| Fixations pour visière Hyban+ | 77325 9 | | universelle | 1 |

VISIÈRE PEDELEC 2.0 / HYBAN 2.0/ HUD-Y ACE



| Article | 4003318 | Couleur | Taille | Unité emb. |
|----------------------------------------------------|---------|--------------|-------------|------------|
| Visière fumée Pedelec 2.0, Hyban 2.0, HUD-Y | 82888 1 | fumée | universelle | 1 |
| Visière transparente Pedelec 2.0, Hyban 2.0, HUD-Y | 82889 8 | transparente | universelle | 1 |
| Fixation de visière Pedelec 2.0, Hyban 2.0, Hud-Y | 82890 4 | | universelle | 1 |

VERRES POUR MASQUE BUTEO



DONNÉES TECHNIQUES

- Revêtement anti-buée
- Disponible avec visière claire, fumée ou effet miroir

| Article | EAN 4003318 | Couleur | Taille | Unité emb. |
|---------------------------|----------------|--------------|-------------|---------------|
| Verres pour masques BUTEO | 68934 5 | transparente | universelle | 1 |
| Verres pour masques BUTEO | 68935 2 | fumée | universelle | 1 |
| Verres pour masques BUTEO | 68936 9 | rouge chromé | universelle | 1 |
| Verres pour masques BUTEO | 68937 6 | noir chromé | universelle | 1 |

LUMIÈRE USB



DONNÉES TECHNIQUES

- Lumière de rechange rechargeable pour le casque HUD-Y
- Augmente la visibilité dans l'obscurité et au crépuscule

| Article | EAN 4003318 | Couleur | Taille | Unité emb. |
|----------------------------|----------------|---------|--------|---------------|
| Lumière USB HUD-Y / PURL-Y | 69446 2 | | | 1 |

LUMIERE USB SMILEY 3.0 / SKURB KID



DONNÉES TECHNIQUES

- Lumière de rechange rechargeable pour casque Smiley 3.0 et Skurb Kid
- Augmente la visibilité dans l'obscurité et au crépuscule

| Article | EAN 4003318 | Couleur | Taille | Unité emb. |
|----------------------------------------------------------|----------------|---------|--------|---------------|
| Lumière LED avec piles pour SMILEY 3.0 / Skurb kid | 91108 8 | | | 1 |
| Lumière LED rechargeable USB pour SMILEY 3.0 / SKURB KID | 69445 5 | | | 1 |

LUMIERE USB URBAN - I 3.0 / HYBAN 2.0 / YOUN-I 2.0



DONNÉES TECHNIQUES

- Lumière de recharge rechargeable pour plusieurs modèles de casques
- Augmente la visibilité dans l'obscurité et au crépuscule

| Article | EAN 4003318 | Couleur | Taille | Unité emb. |
|-------------------------|----------------|---------|--------|---------------|
| Lumière de recharge USB | 97625 4 | | | 1 |

LUMIÈRE USB ADURO 3.0



DONNÉES TECHNIQUES

- Lumière USB rechargeable
- 2 modes : lumière permanente et lumière clignotante
- Bouton caoutchouté pour allumer, passer d'un mode à l'autre et éteindre
- IP44 protégé contre les projections d'eau
- Port micro USB avec cache en caoutchouc (USB Port Cover) pour protéger de l'humidité et de la saleté
- environ 1 heure de charge, environ 2,5 heures d'éclairage
- 8 LED
- Compatible avec l'Aduro 3.0

| Article | EAN 4003318 | Couleur | Taille | Unité emb. |
|-----------------------|----------------|-----------|--------|---------------|
| Lumière USB Aduro 3.0 | 02939 4 | Aduro 3.0 | | |

SPRAY NETTOYANT POUR MOUSSES DE CASQUES



| Article | EAN 4003318 | Couleur | Taille | Unité emb. |
|-------------------------------------|----------------|---------|--------|---------------|
| Spray nettoyant - Pad Fresh MS 30ml | 79188 8 | | 30ml | 1 |

CAPTEUR QUIN

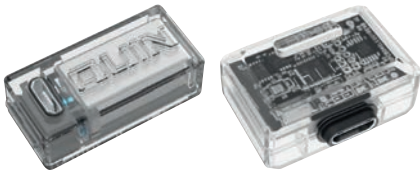

Capteur Quin / Slim

Capteur Quin

DONNÉES TECHNIQUES

- Capteurs de collision - cinq capteurs de contrôle évaluent constamment les données pendant l'utilisation et détectent les situations dangereuses
- IntelliSleep - si aucun mouvement n'est détecté pendant cinq minutes, la puce se met automatiquement en veille et économise de l'énergie
- Bluetooth 5.0 - portée sans fil garantie de 20 mètres pour assurer une connexion stable avec le smartphone.
- Raise to wake - couplage automatique du casque QUIN avec le smartphone dès que la puce QUIN détecte un mouvement.
- Batterie rechargeable - mode de charge rapide de quatre heures via micro USB et jusqu'à un mois d'autonomie

| Article | EAN 4003318 | Couleur | Taille | Unité emb. |
|---------------------|----------------|---------|--------|------------|
| Capteur Quin / Slim | 69319 9 | | | 1 |
| Capteur Quin | 68838 6 | | | 1 |

HOUSSE DE CASQUES ABUS



DONNÉES TECHNIQUES

- Sacoché de transport logotée pour casque
- Poche intérieure faite de tissu protecteur

| Article | EAN 4003318 | Couleur | Taille | Unité emb. |
|------------------------|----------------|---------|-------------|------------|
| Housse de casques ABUS | 78592 4 | noir | universelle | 1 |

HOUSSE DE CASQUE (SPORTIV)



| Article | EAN 4003318 | Couleur | Taille | Unité emb. |
|---------------------------------|----------------|---------|-------------|------------|
| Housse de casque ABUS (Sportiv) | 68451 7 | noir | universelle | 1 |

SET D'AUTOCOLLANTS RÉFLECTEURS

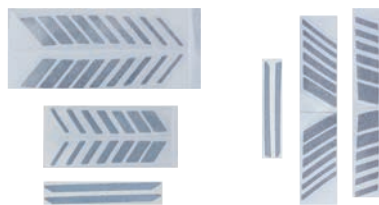

Urban-I 3.0

Hyban 2.0

DONNÉES TECHNIQUES

- Ensemble de stickers réfléchissants pour casque afin d'être visible dans l'obscurité

| Article | EAN 4003318 | Couleur | Taille | Unité emb. |
|--------------------------------------------|----------------|---------|--------|------------|
| Set d'autocollants réflecteurs URBAN-I 3.0 | 88782 6 | argent | | 1 |
| Set d'autocollants réflecteurs HYBAN 2.0 | 88783 3 | argent | | 1 |



LUMINO



**LUMINO
NIGHT VEST**



yellow

Page 270

**LUMINO
DAY VEST**



red

Page 270

URBAN VEST



silver

Page 271

REFLEX VEST



yellow

Page 271

URBAN VEST KIDS



silver

Page 272

REFLEX VEST KIDS



yellow

Page 272

NIGHT COVER



yellow

Page 274

X-URBAN COVER



yellow/silver

Page 274

REFLEX WRAP



yellow

Page 275

EASY MAGNET LIGHT



yellow

Page 276

INDICATOR LIGHT



yellow

Page 276

ACTIVE BAR



yellow/black

Page 277

RAINCAP



yellow

Page 277



black

Page 277

LUMINO NIGHT VEST

CARACTÉRISTIQUES



DONNÉES TECHNIQUES

- 100% polyester
- Bandes réfléchissantes qui brillent dès qu'elles sont éclairées
- Le matériau, résistant aux UV, reste lumineux même après des années d'utilisation
- Visibilité de 150 mètres la nuit et de 100 mètres le jour
- Avec feu arrière intégré composé de quatre puissantes LED rouges - rechargeable via mini-USB
- La lumière LED éclaire jusqu'à 10 heures (fonction lumière continue et clignotante sur simple pression d'un bouton)
- Poche supplémentaire avec fermeture éclair sur le devant du gilet
- Testé selon la norme européenne EN 1150:1999
- Dos rallongé et bonne tenue

| Article | 4003318 | Couleur | Taille | Unité emb. |
|------------------------------|---------|---------|--------|------------|
| Lumino Night Vest jaune M | 96020 8 | jaune | M | 1 |
| Lumino Night Vest jaune L | 96021 5 | jaune | L | 1 |
| Lumino Night Vest jaune XL | 96022 2 | jaune | XL | 1 |
| Lumino Night Vest jaune XXL | 96023 9 | jaune | XXL | 1 |
| Lumino Night Vest jaune XXXL | 96024 6 | jaune | XXXL | 1 |

LUMINO DAY VEST

ACCESSOIRES



DONNÉES TECHNIQUES

- 100% polyester
- Matériau rouge fluorescent qui brille dès qu'il est éclairé
- Le matériau, résistant aux UV, brille même après des années d'utilisation.
- Quatre bandes hautement réfléchissantes pour une très bonne visibilité de nuit, mais aussi une très bonne visibilité de jour.
- Visibilité de 150 mètres la nuit et de 100 mètres le jour
- Languette à l'arrière du gilet pour fixer une lumière séparée (Easy Magnet Light/ Indicator Light)
- Testé selon la norme européenne EN 17353:2020 (AB3)
- Dos allongé et bonne tenue

| Article | 4003318 | Couleur | Taille | Unité emb. |
|----------------------------|---------|---------|--------|------------|
| Lumino Day Vest rouge M | 96026 0 | rouge | M | 1 |
| Lumino Day Vest rouge L | 96027 7 | rouge | L | 1 |
| Lumino Day Vest rouge XL | 96028 4 | rouge | XL | 1 |
| Lumino Day Vest rouge XXL | 96029 1 | rouge | XXL | 1 |
| Lumino Day Vest rouge XXXL | 96031 4 | rouge | XXXL | 1 |

LUMINO URBAN VEST

ACCESSOIRES



DONNÉES TECHNIQUES

- 100% polyester
- Gilet haute visibilité entièrement réfléchissant : La quasi-totalité de la surface du gilet de haute visibilité est éclairée par les phares.
- Rayures coordonnées en couleur
- Visibilité de 150 mètres dans l'obscurité
- Testé selon la norme européenne EN 17353:2020 (B3)
- Languette à l'arrière du gilet pour fixer une lumière séparée (Easy Magnet Light/ Indicator Light)
- Dos allongé et bonne tenue

| Article | 4003318 | Couleur | Taille | Unité emb. |
|-------------------------------|---------|---------|--------|------------|
| Lumino Urban Vest argent M | 69937 5 | argent | M | 1 |
| Lumino Urban Vest argent L | 69938 2 | argent | L | 1 |
| Lumino Urban Vest argent XL | 69944 3 | argent | XL | 1 |
| Lumino Urban Vest argent XXL | 90943 6 | argent | XXL | 1 |
| Lumino Urban Vest argent XXXL | 96034 5 | argent | XXXL | 1 |

LUMINO REFLEX VEST

ACCESSOIRES



DONNÉES TECHNIQUES

- 100% polyester
- Matériau jaune fluorescent qui brille dès qu'il est éclairé
- Le matériau résistant aux UV brille même après des années d'utilisation.
- Quatre bandes hautement réfléchissantes pour une très bonne visibilité de nuit, mais aussi une très bonne visibilité de jour.
- Visibilité de 150 mètres la nuit et de 100 mètres le jour
- Languette à l'arrière du gilet pour fixer une lumière séparée (Easy Magnet Light/ Indicator Light)
- Testé selon la norme européenne EN 17353:2020 (AB3)
- Dos allongé et bonne tenue

| Article | EAN 4003318 | Couleur | Taille | Unité |
|-------------------------------|----------------|---------|--------|-------|
| Lumino Reflex Vest jaune M | 69928 3 | jaune | emb. | 1 |
| Lumino Reflex Vest jaune L | 69935 1 | jaune | L | 1 |
| Lumino Reflex Vest jaune XL | 69936 8 | jaune | XL | 1 |
| Lumino Reflex Vest jaune XXL | 90942 9 | jaune | XXL | 1 |
| Lumino Reflex Vest jaune XXXL | 96033 8 | jaune | XXXL | 1 |

LUMINO URBAN VEST KIDS

ACCESSOIRES



DONNÉES TECHNIQUES

- 100% polyester
- Gilet haute visibilité entièrement réfléchissant : La quasi-totalité de la surface du gilet de haute visibilité est éclairée par les phares.
- Rayures coordonnées en couleur
- Visibilité de 150 mètres dans l'obscurité
- Testé selon la norme européenne EN 17353:2020 (B3)
- La fermeture éclair assure une bonne tenue sur le corps

| Article | 4003318 | Couleur | Taille | Unité emb. |
|---------------------------------|---------|---------|--------|------------|
| Lumino Urban Vest Kids argent S | 69948 1 | argent | S | 1 |
| Lumino Urban Vest Kids argent M | 69949 8 | argent | M | 1 |
| Lumino Urban Vest Kids argent L | 69950 4 | argent | L | 1 |

LUMINO REFLEX VEST KIDS

ACCESSOIRES



DONNÉES TECHNIQUES

- 100% polyester
- Matériau jaune fluorescent qui brille dès qu'il est éclairé
- Le matériau, résistant aux UV, brille même après des années d'utilisation.
- Quatre bandes hautement réfléchissantes pour une très bonne visibilité de nuit, mais aussi une très bonne visibilité de jour.
- Visibilité de 150 mètres la nuit et de 100 mètres le jour
- Très bonne tenue grâce à la fermeture éclair
- Testé selon la norme européenne EN 17353:2020 (AB3)

| Article | 4003318 | Couleur | Taille | Unité emb. |
|---------------------------------|---------|---------|--------|------------|
| Lumino Reflex Vest Kids jaune S | 69945 0 | jaune | S | 1 |
| Lumino Reflex Vest Kids jaune M | 69946 7 | jaune | M | 1 |
| Lumino Reflex Vest Kids jaune L | 69947 4 | jaune | L | 1 |



LUMINO NIGHT COVER



DONNÉES TECHNIQUES

- Housse de pluie pour sac à dos avec feu arrière intégré - composé de quatre puissantes LED rouges
- Fonction de lumière continue et clignotante par simple pression d'un bouton
- Rechargeable via mini USB
- La lumière LED brille jusqu'à 10 heures (après la charge)
- 2 sangles élastiques réglables pour s'adapter au sac à dos
- Visibilité de 150 mètres la nuit et de 100 mètres le jour
- Adapté au temps pluvieux grâce à un extérieur entièrement soudé et étanche
- Housse de pluie imperméable

Article

Lumino Night Cover jaune

4003318

69954 2

Couleur

jaune

Unité emb.

1

LUMINO X- URBAN COVER



DONNÉES TECHNIQUES

- Housse de pluie pour sac à dos jaune fluorescent qui brille dès qu'il est éclairé
- Bandes hautement réfléchissantes pour une très bonne visibilité de nuit, mais aussi une très bonne visibilité de jour.
- Visibilité de 150 mètres la nuit et de 100 mètres le jour
- 2 sangles élastiques réglables pour s'adapter au sac à dos
- Adapté au temps pluvieux grâce à un extérieur entièrement soudé et étanche
- Housse de pluie imperméable

Article

Lumino X-Urban Cover jaune / argenté

4003318

69955 9

Couleur

jaune / argenté

Unité emb.

1

LUMINO REFLEX WRAP



DONNÉES TECHNIQUES

- Matériau jaune fluorescent qui brille dès qu'il est éclairé
- Deux bandes hautement réfléchissantes pour une très bonne visibilité de nuit, mais aussi une très bonne visibilité de jour.
- Matériau résistant aux UV (conforme aux exigences de la norme européenne EN2471), brille même après des années d'utilisation.
- Visibilité de 150 mètres la nuit et de 100 mètres le jour
- S'adapte à votre morphologie grâce à la fermeture Velcro (de 82 à 108 cm de circonférence environ)

| Article | | Couleur | Unité emb. |
|--------------------------|--------------------|---------|------------|
| Lumino Reflex Wrap jaune | 4003318 69952 8 | jaune | 1 |



LUMINO EASY MAGNET LIGHT



DONNÉES TECHNIQUES

- Fonction lumière permanente et lumière clignotante par simple pression sur un bouton
- Rechargeable via micro USB
- Matériau jaune brillant de haute qualité, avec 4 LED rouges
- La bande lumineuse peut être facilement fermée à l'aide de la fermeture magnétique
- La lumière LED brille jusqu'à 10 heures (après la charge)
- Adapté au temps pluvieux grâce à un extérieur entièrement soudé et étanche
- Visibilité de 150 mètres la nuit et de 100 mètres le jour
- Testé selon la norme européenne EN 13356:2001

Article

| Article | 4003318 | Couleur | Unité emb. |
|--------------------------------|---------|---------|------------|
| Lumino Easy Magnet Light jaune | 69960 3 | jaune | 1 |

LUMINO INDICATOR LIGHT



DONNÉES TECHNIQUES

- Fonction de lumière continue et clignotante par simple pression d'un bouton
- Pile remplaçable CR2032 incluse
- Matériau brillant de haute qualité, jaune avec 4 LED rouges puissantes
- Avec une fermeture Velcro pratique permettant de l'attacher à divers objets
- Fonctionne jusqu'à 100 heures
- Adapté au temps pluvieux grâce à un extérieur entièrement soudé et étanche

Article

| Article | 4003318 | Couleur | Unité emb. |
|------------------------------|---------|---------|------------|
| Lumino Indicator Light jaune | 69958 0 | jaune | 1 |

LUMINO ACTIVE BAR



DONNÉES TECHNIQUES

- Fonction de lumière continue et clignotante par simple pression d'un bouton
- Pile remplaçable CR2032 incluse
- Fonctionne jusqu'à 100 heures
- Adapté au temps pluvieux grâce à un extérieur entièrement soudé et étanche
- Testé selon la norme européenne EN 13356:2001
- Visibilité de 150 mètres la nuit et de 100 mètres le jour

| Article | 4003318 | Couleur | Unité emb. |
|--------------------------------|---------|--------------|------------|
| Lumino Active Bar jaune / noir | 69957 3 | jaune / noir | 1 |

CAPUCHE



VARIANTES



jaune

noir

DONNÉES TECHNIQUES

- Equipée d'un élastique pour un ajustage parfait de la capuche à la taille du casque

| Article | 4003318 | Couleur | Taille | Unité emb. |
|---------|---------|---------|-------------|------------|
| Capuche | 52151 5 | jaune | universelle | 1 |
| Capuche | 52154 6 | noir | universelle | 1 |

AMÉNAGER LE MAGASIN AVEC SUCCÈS

Du point de vue de la psychologie de vente, la manière dont vous aménagez votre magasin est décisive pour votre succès commercial. Nous vous aidons à aménager votre surface de vente de manière conviviale. Ainsi, vous assurez des ventes réussies non seulement aujourd'hui, mais aussi à l'avenir. Car vos clients reviendront toujours.

1. SE DÉMARQUER

Assurez-vous que votre magasin se distingue de la masse et faites en sorte que vos clients se sentent à l'aise dans votre magasin grâce à une atmosphère confortable.

2. CONVAINCRE PAR LA QUALITÉ

Une longue expérience, des processus de développement bien pensés et des matériaux de haute qualité sont décisifs aussi bien pour les produits eux-mêmes que pour les moyens de présentation.

ABUS vous propose les deux.

3. SE SOUVENIR

Créez des expériences qui vont au-delà de la simple mise à disposition et de la vente de marchandises. Toucher, essayer - partir à la découverte. C'est là que réside votre avantage, surtout par rapport au commerce en ligne.



NOUS VOUS ACCOMPAGNONS DANS LA VENTE

Vos besoins en tant que revendeur sont très importants pour nous. Notre nouveau système de mobilier est donc conçu pour refléter au mieux la marque ABUS, tout en vous laissant la liberté pour votre stratégie de vente et de vos surfaces commerciales.

CONCEPTION MODULAIRE :

Hauteur, largeur, emplacement du produit, placement dans la pièce, dans un coin ou contre le mur : C'est vous qui décidez !



NOMBREUX MODULES :

Attirer l'attention, catégoriser, informer - combinez les outils selon vos besoins.

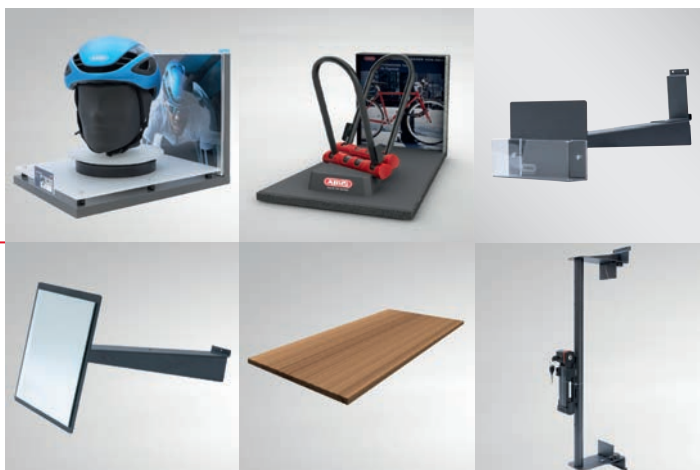

DESIGN MODERNE :

Des éléments en métal et en bois combinés dans un look épuré - le concept de design de votre magasin ne sera pas perturbé.

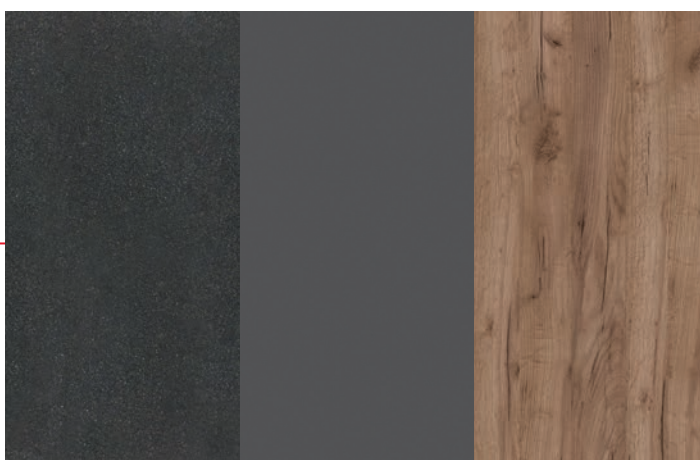

Revêtement en
poudre DB703
structure fine

Gris graphite
Kronospan décor
0162

Chêne tabac
artisanal
Décor Kronospan
K004

CRÉEZ DÈS MAINTENANT VOTRE ESPACE DE VENTE PERSONNEL ABUS !

AFFICHAGE MURAL

Exploitez pleinement la hauteur et la largeur de vos murs pour mettre en valeur vos produits ABUS.

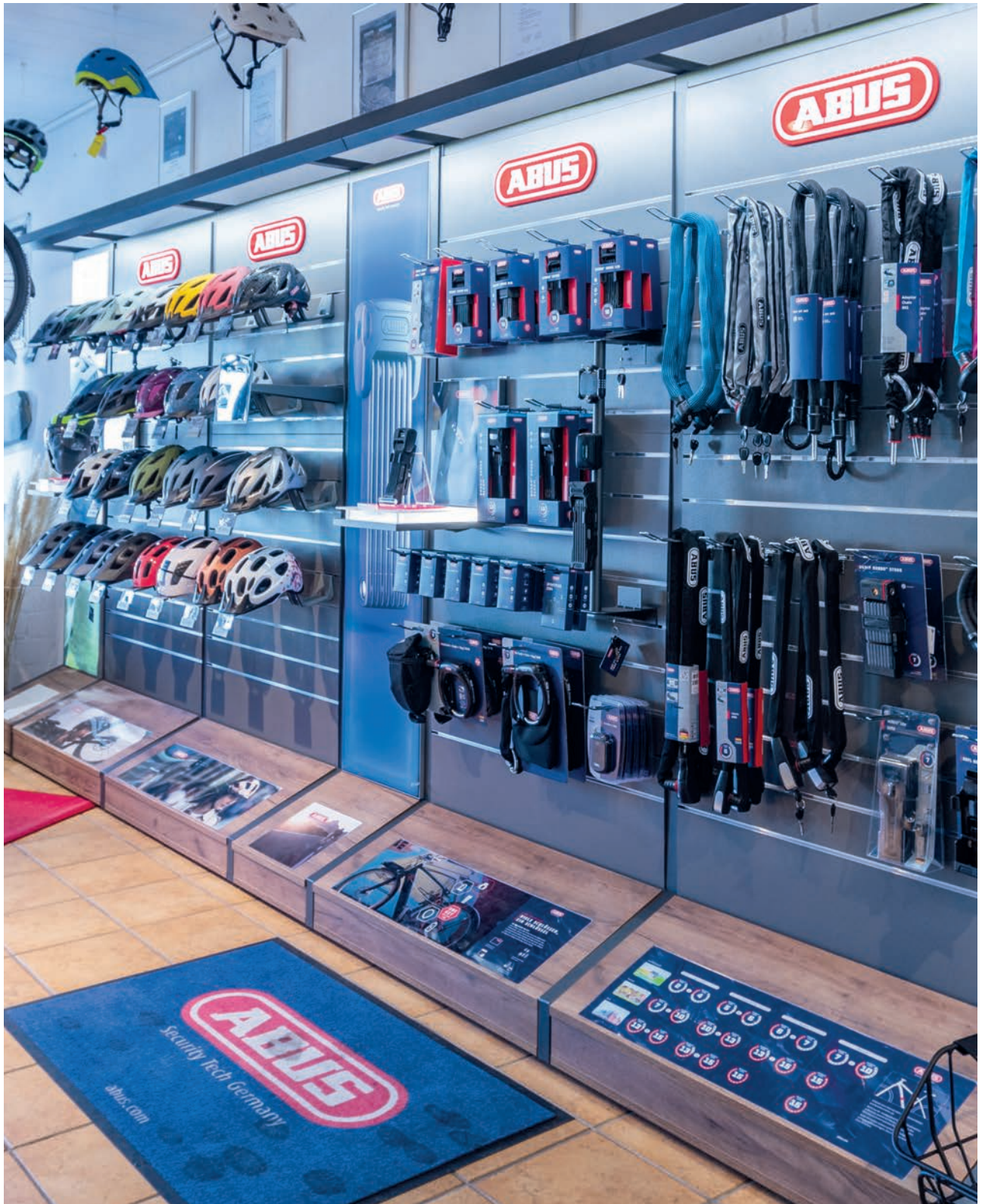

DIMENSIONS DU PRÉSENTOIR MURAL

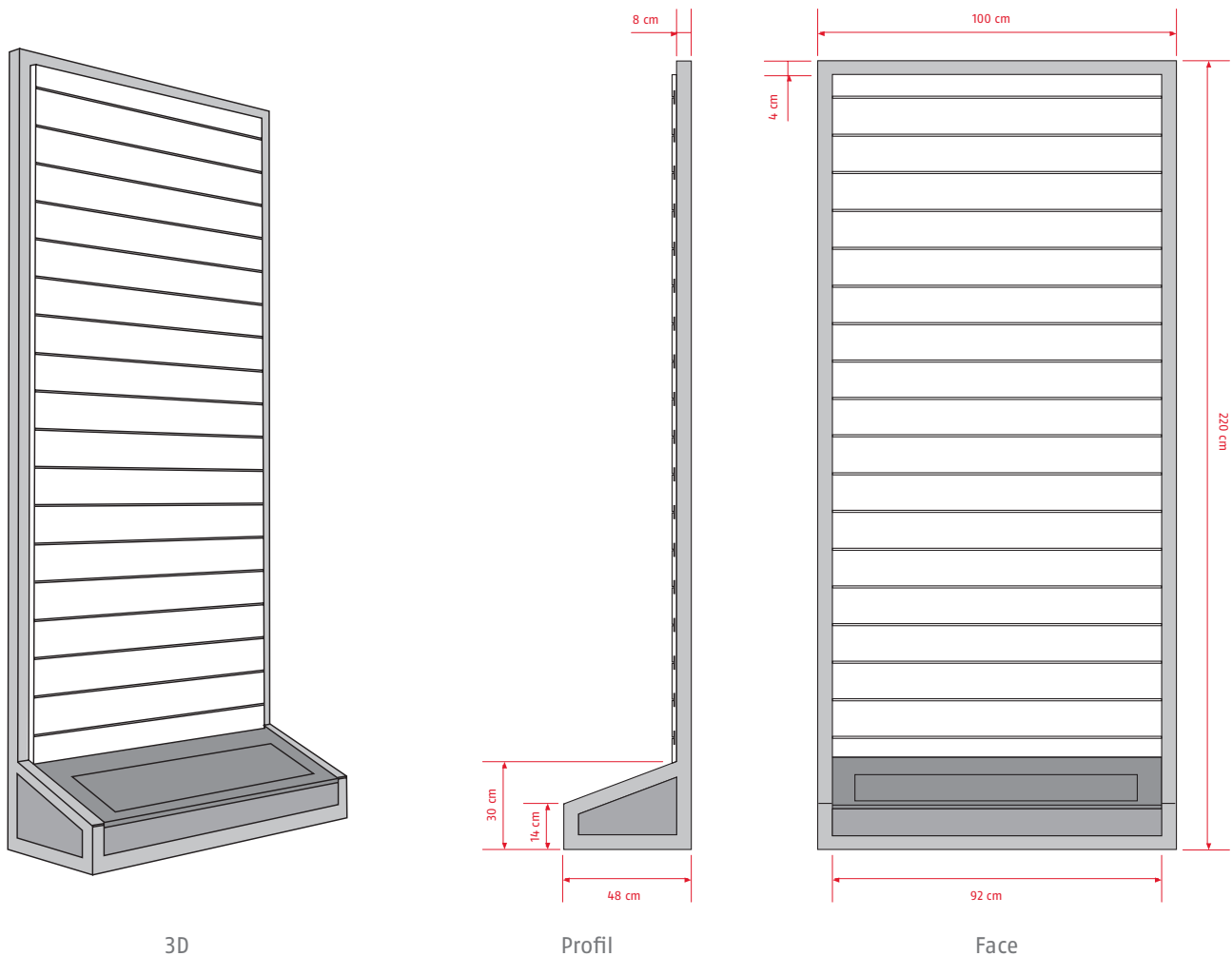

CARACTÉRISTIQUES PRÉSENTOIR MURAL:

Disponible en largeur de 100 cm ou 50 cm

La hauteur peut être augmentée par paliers de 40 cm avec des panneaux supplémentaires

Mur à lamelles avec possibilité d'alimentation électrique pour l'éclairage, etc.



Base en aspect bois avec supports PLV amovibles

Le couvercle étant amovible, vous pouvez utiliser l'espace comme un espace de rangement

Possibilité d'utiliser des supports visuels sur toute la surface

PRÉSENTOIR AUTOPORTANT

Développez et structurez vos catégories de produits ABUS avec des présentoirs autoportants - par exemple pour les nouveaux produits et les offres spéciales.



DIMENSIONS DU PRÉSENTOIR AUTOPORTANT

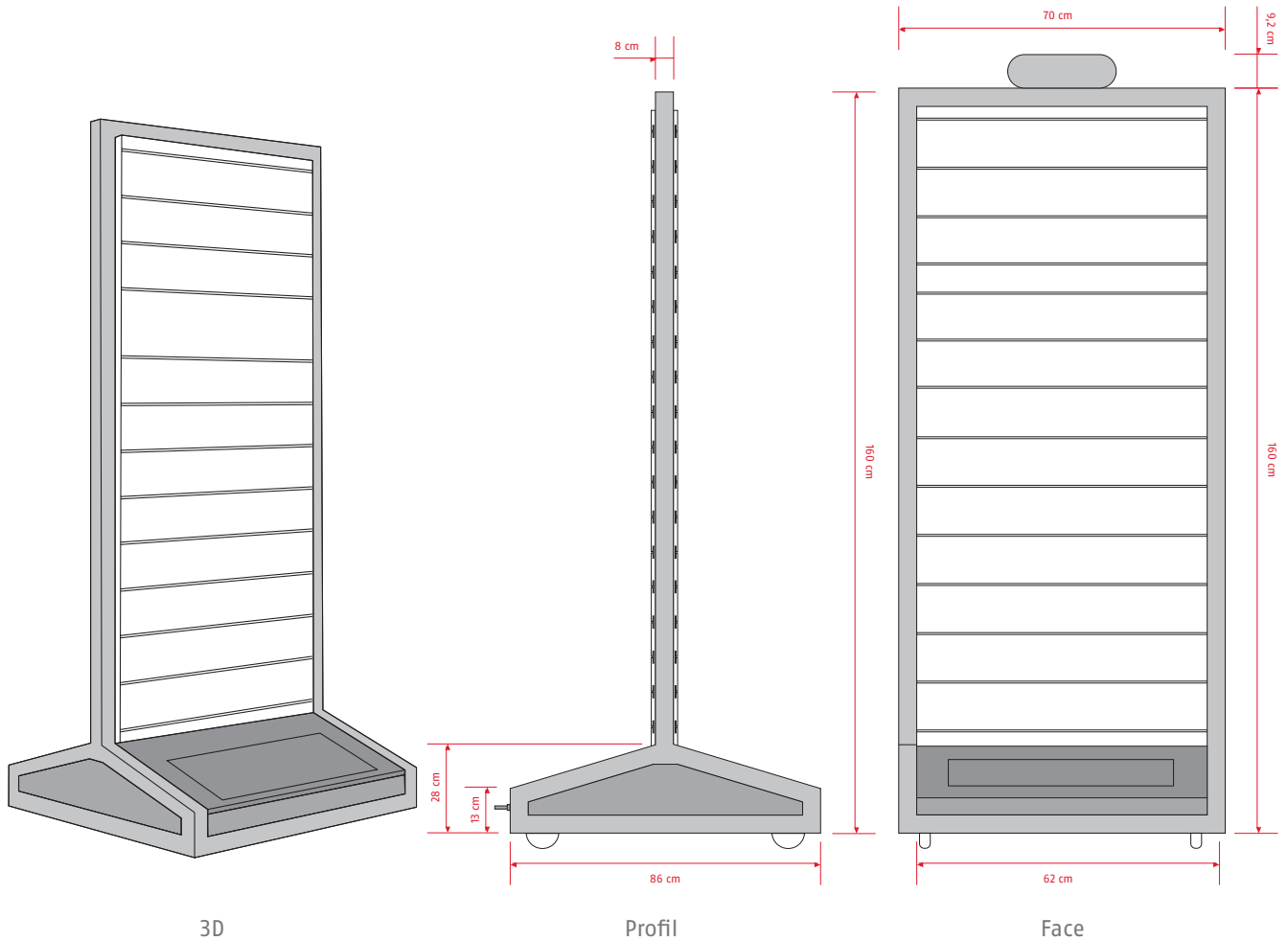

CARACTÉRISTIQUES PRÉSENTOIR AUTOPORTANT:

Base en aspect bois avec supports PLV amovibles



Le couvercle étant amovible, vous pouvez utiliser l'espace comme un espace de rangement



Roulettes en option pour déplacer facilement le présentoir



OPTIMISATION - SIGNALÉTIQUE - EMOTION - EXPERIENCE LE TOUT EN HARMONIE

Notre nouveau système de présentation offre de nombreuses possibilités de combinaisons.
Vous pouvez choisir et équiper vos présentoirs en fonction de votre assortiment et de vos locaux.



FONCTIONNALITÉ ET ÉMOTION

Bien combinés, les différents éléments offrent de nombreux avantages.



Parfait équilibre entre la proportion de produits et d'éléments visuels adaptés à l'assortiment

Facilité d'orientation du client grâce aux balisages de linéaire par catégorie de produits

Large choix d'images en toile tendue



Espace de rangement dans le socle pour entreposer proprement des produits

Affichages interchangeables avec des informations sur les produits pour guider le client

INDEX

| Article | Page | Article | Page | Article | Page |
|------------------------------|------|------------------------------|------|----------------------------------------|------|
| Antivols | | Antivols | | Supports d'antivols et sacoches | |
| 64TI | 125 | GRANIT™ WBA 75 | 111 | ADAPTATEUR STRAP LH | 144 |
| 70 & 70IB | 126 | IVEN Chain 8210 | 50 | BASICO ST 5200 | 146 |
| 145 | 124 | IVEN Steel-0-Flex™ 8200 | 68 | Chain Bag ST 2012 | 140 |
| 147TSA | 127 | IVERA Cable 7220 | 84 | Oryde ST 2085 | 145 |
| 402 | 25 | IVERA Chain 7210 | 51 | Oryde ST 2100 | 146 |
| 440 Alarm | 23 | IVERA Chain 7210 Color | 51 | Oryde ST 2200 | 145 |
| 1200 Web | 61 | IVERA Steel-0-Flex™ 7200 | 69 | Oryde ST 2250 | 145 |
| 1500 Web | 61 | IVY Chain 9210 | 47 | Sac ST 5850/5650/4960 | 141 |
| 1850 | 117 | IvyTex Adapter Chain | 101 | Shackle Clamp | 134 |
| 3406C | 89 | KeyGarage™ 767 | 123 | ST 5950 2.0 | 146 |
| 3406K | 89 | KeyGarage™ 787 | 121 | Support EaZy KF™ | 133 |
| 3506C | 83 | KeyGarage™ 787 BIG | 120 | Support Fidlock FL | 142 |
| 3506K | 83 | KeyGarage™ 787 BIG LED | 120 | Support Fidlock TexFL | 142 |
| 4408C | 88 | KeyGarage™ 787 LED | 121 | Support GH 50 | 134 |
| 4408K | 88 | KeyGarage™ 797 | 122 | Support IVERA RBU | 139 |
| 4650S / SL | 98 | KeyGarage™ 797 LED | 122 | Support KF | 144 |
| 4650X / XL | 98 | KeyGarage™ Smart 787 | 119 | Support Quick Store QST | 140 |
| 6206K Goose Lock | 65 | KeyGarage™ Smart 797 | 119 | Support QuickSnap | 143 |
| 8808C | 49 | Microflex 6615K | 73 | Support QuickSnap RBU | 143 |
| ACH 2.0 Adaptor Chain | 100 | Numerino 5410C | 87 | Support Saddleflex QST | 140 |
| ADAPTOR CABLE | 100 | Numero 5510C | 81 | Support Saddleflex SH SF | 135 |
| AFS625 | 118 | PHANTOM™ 8950 | 78 | Support SCLL | 141 |
| Alarmbox 2.0 | 109 | PHANTOM™ 8960 | 70 | Support Selle Royale (5C,5K,6C,6K) | 142 |
| Alarmbox RC | 109 | Primo 5410K | 87 | Support SH 5700 BORDO™ | 137 |
| Booster 6512K | 80 | Primo 5510K | 81 | Support SH 5700 uGrip BORDO™ BIG | 137 |
| BORDO GRANIT™ 6500K | 32 | PRO AMPARO 4750 S / SL | 97 | Support SH 6000 BORDO™ | 136 |
| BORDO GRANIT™ 6500KA | 31 | PRO AMPARO 4750 X / XL | 96 | Support SH 6000 BORDO™ BIG | 137 |
| BORDO™ 6000C | 36 | PRO TECTIC™ 4960 | 99 | Support SH 6055 BORDO™ Lite | 138 |
| BORDO™ 6000C LED | 37 | PS88 | 118 | Support SH 6055 Selle Royal | 138 |
| BORDO™ 6000K | 35 | Racer 6412K | 86 | Support SH 6500 BORDO XPlus™ | 136 |
| BORDO™ 6000KA | 34 | Raydo Pro 1450 | 79 | Support SH 6500K BORDO™ | 135 |
| BORDO™ 6500A SmartX | 30 | Sportflex 2504 | 114 | Support SH B | 132 |
| BORDO™ Lite 6055C | 41 | Star 4508C | 82 | Support SH FL | 136 |
| BORDO™ Lite 6055K | 40 | Star 4508K | 82 | Support SH6500A SmartX™ | 135 |
| BORDO™ One 6000A | 33 | Steel-0-Chain™ 4804C | 60 | Support Snap Cage | 141 |
| Catena 6806K | 56 | Steel-0-Chain™ 4804C SYMBOLS | 60 | Support ST 5700 uGrip BORDO™ | 139 |
| Catena 6806 Color | 57 | Steel-0-Chain™ 4804K | 59 | Support ST 6000 BORDO™ | 138 |
| Catena 6806K Neon | 56 | Steel-0-Chain™ 5805C | 58 | Support ST 6000 BORDO™ BIG | 139 |
| Catena 6806K Reflective | 57 | Steel-0-Chain™ 5805K | 58 | Support TexKF Mini | 143 |
| Centuro 860 | 69 | Steel-0-Chain™ 8807K | 52 | Support UGH 02 | 134 |
| Chaîne 6KS Loop | 116 | Steel-0-Chain™ 9808K | 48 | Support URB | 144 |
| Chain Claw 10 | 108 | Steel-0-Chain™ 9809K | 48 | Support USH 540 / 470 / 460 / 440A TEX | 133 |
| CityChain™ 1010 | 47 | Steel-0-Flex™ 950 | 68 | Support USKF | 133 |
| Cobra™ | 117 | Steel-0-Flex™ Raydo Pro 1460 | 71 | | |
| Combiflex™ | 114 | Steel-0-Flex™ Tresor 1360 | 72 | | |
| Combiflex™ Adventure | 115 | TECTIC™ 496 | 99 | | |
| Combiflex™ Travelguard | 115 | Tresor 1385 | 53 | | |
| CombiLoop 205 | 116 | Tresor 1385 Color | 54 | | |
| Diskus® 20 | 127 | Tresor 1385 Neon | 55 | | |
| Diskus® 24IB | 126 | Tresor 6412C | 86 | | |
| Facilo 32 | 25 | Tresor 6512C | 80 | | |
| GRANIT CityChain XPlus™ 1060 | 46 | Tresorflex 6615C | 73 | | |
| GRANIT XPlus™ 540 | 18 | uGrip BORDO™ 5700 Combo | 39 | | |
| GRANIT XPlus™ 6950 | 94 | uGrip BORDO™ 5700K | 38 | | |
| GRANIT™ 460 | 22 | Ultimate 420 | 21 | | |
| GRANIT™ Power 58 | 16 | Ultra 410 | 24 | | |
| GRANIT™ Plus 470 | 20 | WA 50 | 113 | | |
| GRANIT™ Plus 640 | 19 | WBA 60 | 113 | | |
| GRANIT™ Super Extreme 2500 | 17 | WBA 65 | 112 | | |
| GRANIT™ WBA 100 | 111 | WCH90 | 110 | | |

INDEX

| Article Casques | Page | Article Lumino | Page |
|-----------------------------------------------|-----------|-------------------|------|
| Aduro 3.0 | 236 - 237 | Active Bar | 277 |
| AirBreaker | 160 - 161 | Capuche | 277 |
| AirDrop | 182 - 183 | Easy Magnet Light | 276 |
| Buteo | 194 - 195 | Indicator Light | 276 |
| Capteur QUIN | 267 | Lumino Day Vest | 270 |
| Capuche | 263 | Lumino Night Vest | 270 |
| Capuche Toplight | 263 | Night Cover | 274 |
| Casquette | 263 | Reflex Vest | 271 |
| CliffHanger | 186 - 187 | Reflex Vest Kids | 272 |
| GameChanger 2.0 | 166 - 167 | Reflex Wrap | 275 |
| GameChanger TRI | 164 - 165 | Urban Vest | 271 |
| GameChanger TT | 162 - 163 | Urban Vest Kids | 272 |
| HiDrop | 184 - 185 | X-Urban Cover | 274 |
| HOUSSE DE CASQUE (SPORTIV) | 267 | | |
| Housse de casques ABUS | 267 | | |
| HUD-Y | 212 - 213 | | |
| HUD-Y ACE | 210 - 211 | | |
| Hyban 2.0 | 226 - 227 | | |
| Hyban 2.0 ACE | 224 - 225 | | |
| Hyban 2.0 LED | 222 - 223 | | |
| Kit hiver | 262 | | |
| KIT HIVER PEDELEC 2.0 | 262 | | |
| KIT HIVER Scraper 3.0 | 262 | | |
| LUMIERE USB | 266 | | |
| LUMIÈRE USB | 265 | | |
| Lumière USB Aduro 3.0 | 266 | | |
| LUMIERE USB SMILEY 3.0 / SKURB KID | 265 | | |
| Macator | 176 - 177 | | |
| MoDrop | 190 - 191 | | |
| MoTrip | 192 - 193 | | |
| Moventor 2.0 | 188 - 189 | | |
| Pedelec 1.1 | 208 - 209 | | |
| Pedelec 2.0 | 206 - 207 | | |
| Pedelec 2.0 ACE | 204 - 205 | | |
| PowerDome | 172 - 173 | | |
| PowerDome ACE | 170 - 171 | | |
| PURL-Y | 220 - 221 | | |
| PURL-Y ACE | 218 - 219 | | |
| Scraper 3.0 | 234 - 235 | | |
| Scraper 3.0 ACE | 232 - 233 | | |
| SET D'AUTOCOLLANTS RÉFLECTEURS | 267 | | |
| Skurb | 230 - 231 | | |
| Skurb ACE | 228 - 229 | | |
| Skurb Kid | 250 - 251 | | |
| Smiley 3.0 | 256 - 257 | | |
| Smiley 3.0 ACE LED | 252 - 253 | | |
| Smiley 3.0 LED | 254 - 255 | | |
| Smooty 2.0 | 258 - 259 | | |
| SPRAY NETTOYANT POUR MOUSSES DE CASQUES | 266 | | |
| StormChaser ACE | 168 - 169 | | |
| Urban-I 3.0 | 216 - 217 | | |
| Urban-I 3.0 ACE | 214 - 215 | | |
| Verres pour masque BUTEO | 265 | | |
| Visiere GameChanger TT/Tri | 264 | | |
| VISIÈRE HYBAN+ | 264 | | |
| Visière PEDELEC 2.0 / HYBAN 2.0/ HUD-Y ACE | 264 | | |
| WingBack | 174 - 175 | | |
| YouDrop | 244 - 245 | | |
| YouDrop FF | 242 - 243 | | |
| Youn-I 2.0 | 246 - 247 | | |
| Youn-I MIPS | 248 - 249 | | |

CARTE DE NOS COMMERCIAUX PAR SECTEUR

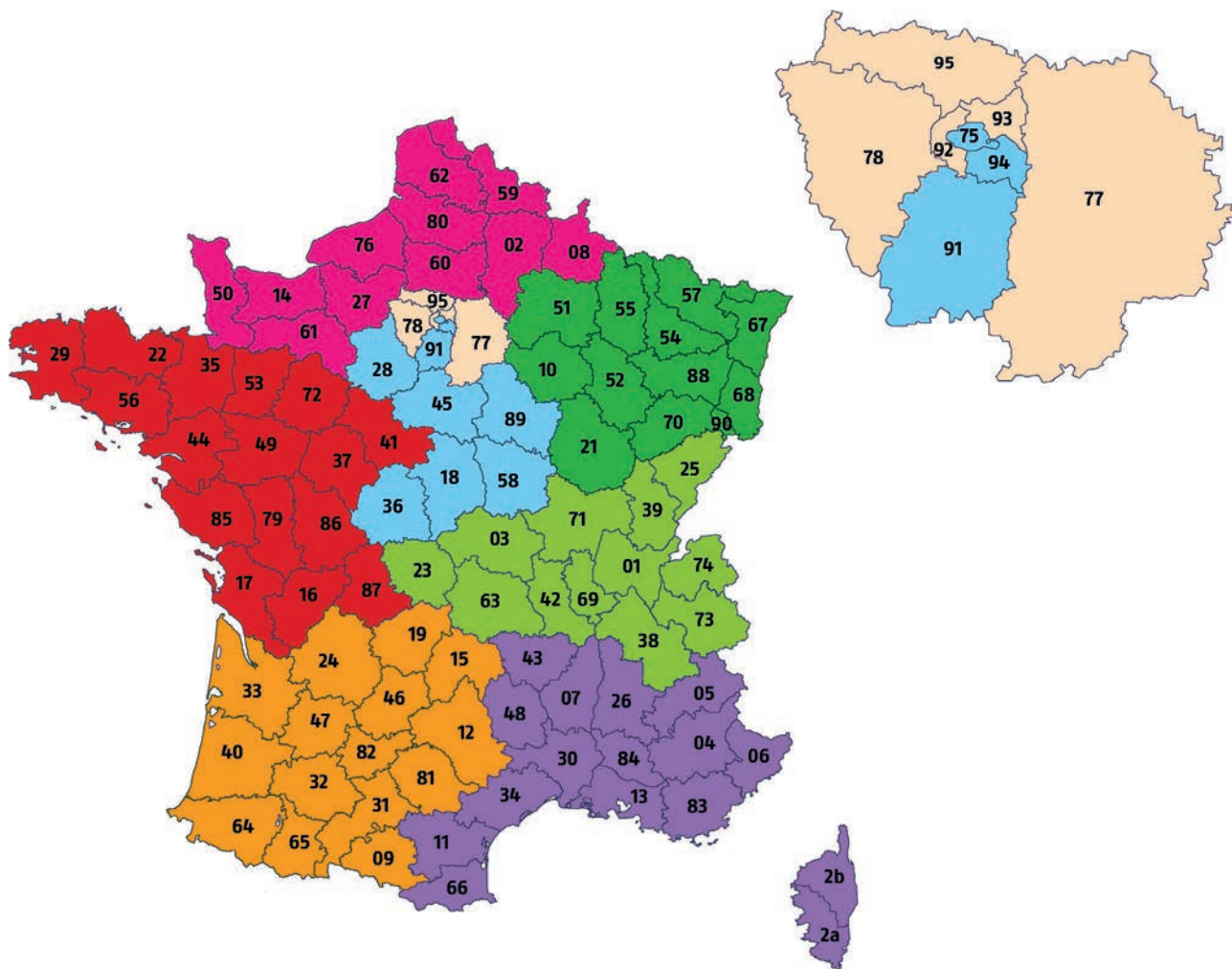

● **SECTEUR IDF ET CENTRE**
Thierry JEANSON
Tél. : 06 17 82 47 09
Mail : thierry.jeanson@abus.fr
Assistante service client :
Virginie PINARDEL - Tél. : 01 49 61 67 68

● **SECTEUR OUEST**
Germain LAMBERT
Tél. : 06 17 82 47 22
Mail : germain.lambert@abus.fr
Assistante service client :
Laetitia TELLEZ - Tél : 01 49 61 23 20

● **SECTEUR IDF**
Sabrina HARROSH
Tél. : 06 21 35 80 02
Mail : sabrina.harrosh@abus.fr
Assistante service client :
Zelda ROLAND - Tél. : 01 49 61 23 16

● **SECTEUR NORD-EST**
David PFENNIG
Tél. : 06 17 82 47 12
Mail : david.pfennig@abus.fr
Assistante service client :
Émeline PHIBEL - Tél : 01 49 61 68 06

● **SECTEUR CENTRE-EST**
Pierre RUDY
Tél. : 06 17 82 47 28
Mail : pierre.rudy@abus.fr
Assistante service client :
Corinne Guillou - Tél : 01 49 61 67 77

● **SECTEUR NORD**
Damien MONNIER
Tél. : 06 21 35 80 13
Mail : damien.monnier@abus.fr
Assistante service client :
Virginie PINARDEL - Tél. : 01 49 61 67 68

● **SECTEUR SUD-OUEST**
Séverine JOUAN CHAVANT
Tél. : 06 17 82 46 75
Mail : severine.jouan@abus.fr
Assistant service client :
Virgile KOUAO - Tél : 01 49 61 23 17

● **SECTEUR SUD-CENTRE / SUD-EST**
Jean-François GALFRE
Tél. : 06 17 82 47 35
Mail : jean-francois.galfre@abus.fr
Assistant service client :
Virgile KOUAO - Tél : 01 49 61 23 17

POUR PASSER COMMANDES Mail : serviceclients@abus.fr ou Web : partner-fr.abus.com



Security Tech Germany

© ABUS | FRANCE S.A.S
abus.com

15, voie de la Gravière
94290 Villeneuve le Roi
France
contact@abus.fr
+33 (0)1 49 61 67 67



Imprimé sur du papier issu de forêts durables. Sous réserve de modifications techniques et de présentation.
Nous déclinons toute responsabilité pour des erreurs d'impression. © ABUS 2023



KAT MoSi 2024 Gesamt
FR ohne Preise



4 0 0 3 3 1 8 9 9 3 5 2 7